

VCS0 96 11 VR-VCS0 690

Pos.28

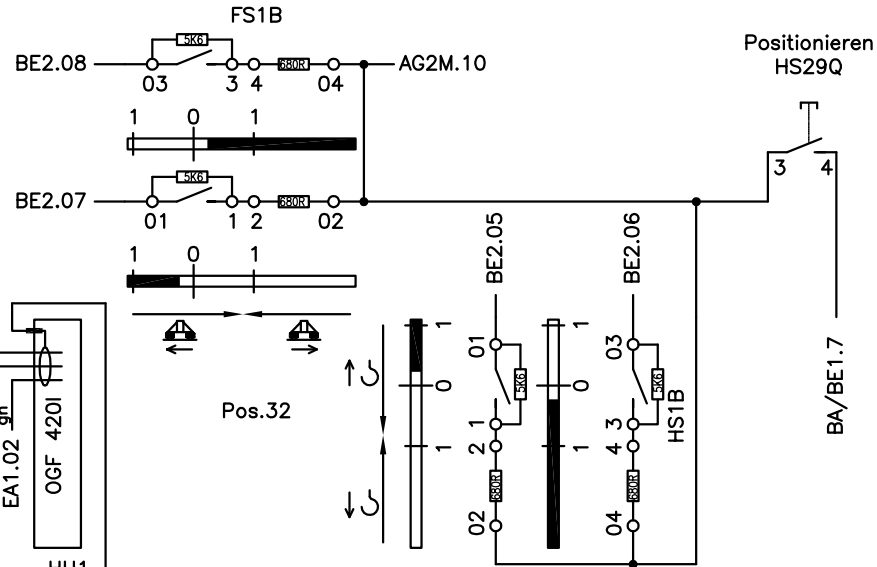

Pos.31
Sensor
Totmann

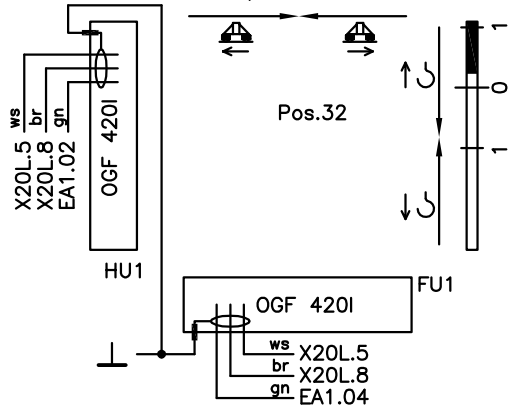
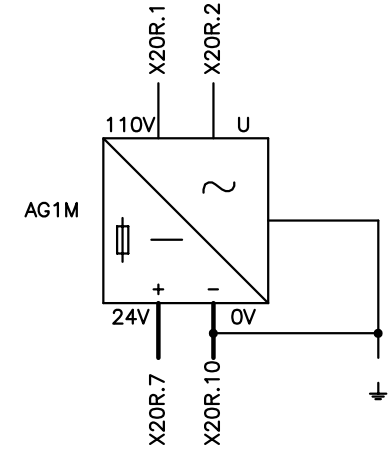
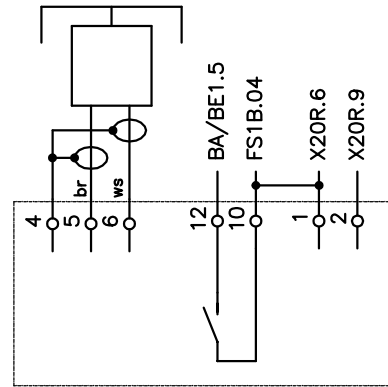

Positionieren

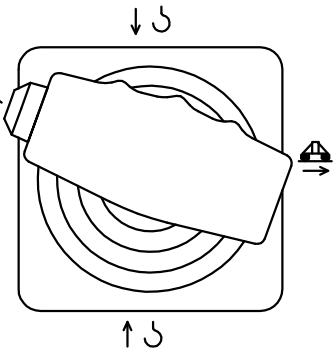

24V = Spannungsversorgung
für ABB Geräte BA/BE1, EA1 und BE2 1,5φ blau
Verdrahtung: rot 0,75qmm
Gleichspannung 24V=: Hellblau 0,5qmm

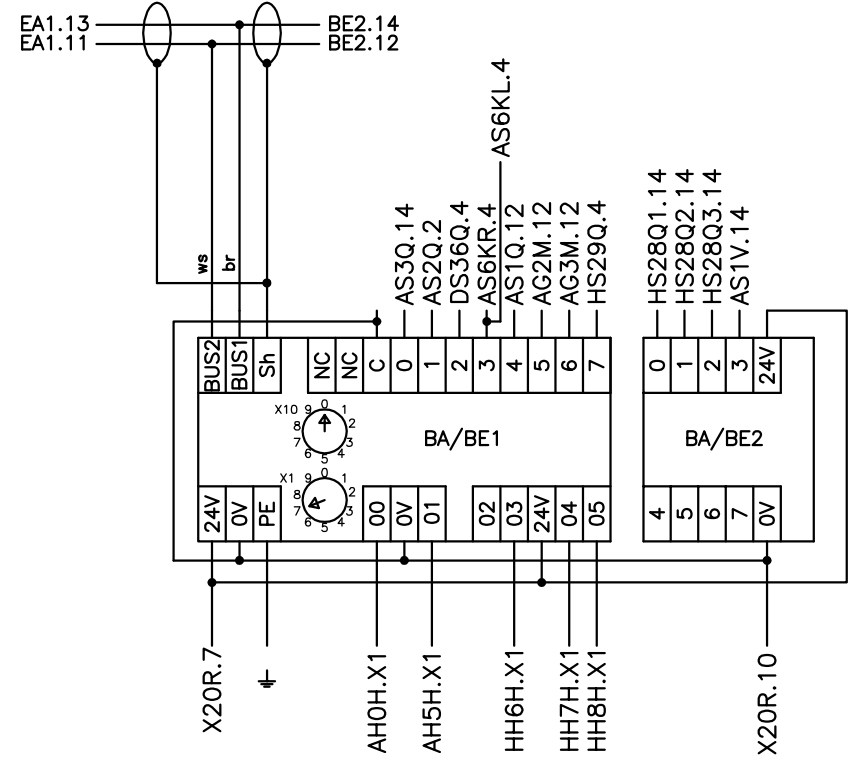

MAßSTAB: DATUM: NAME:

11.01.2006 R.Steeb

SPOHN & BURKHARDT
D 89143 BLAUBEUREN TEL. 07344/171-0

BEZEICHNUNG:
Fahrersitz FSLHD 257 rechts

KUNDE: LIEBHERR

ID-NR.: 1016 7818

ZEICHNUNGS.-NR.:

SS 13 542

VON: 4

BLATT: 1

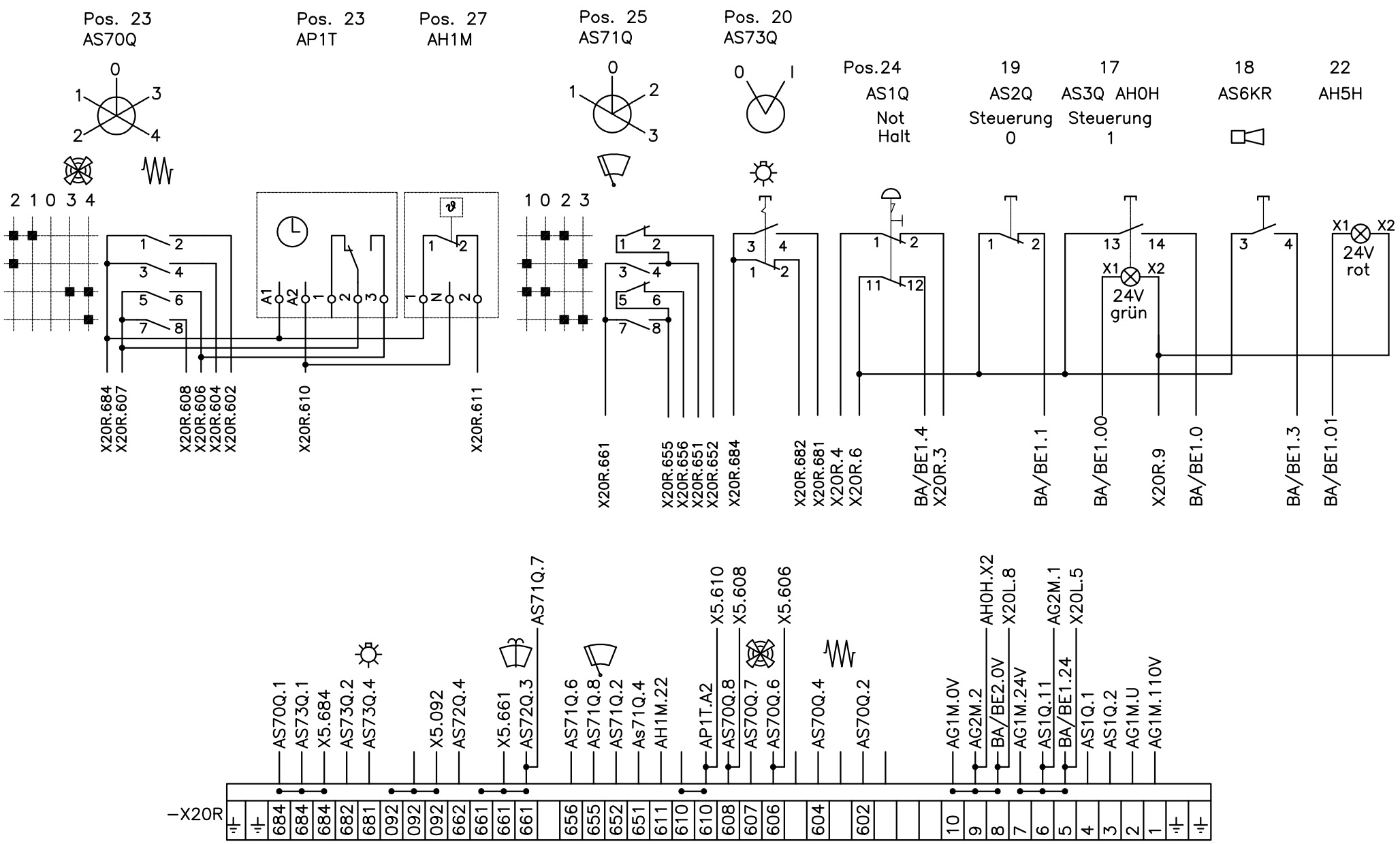

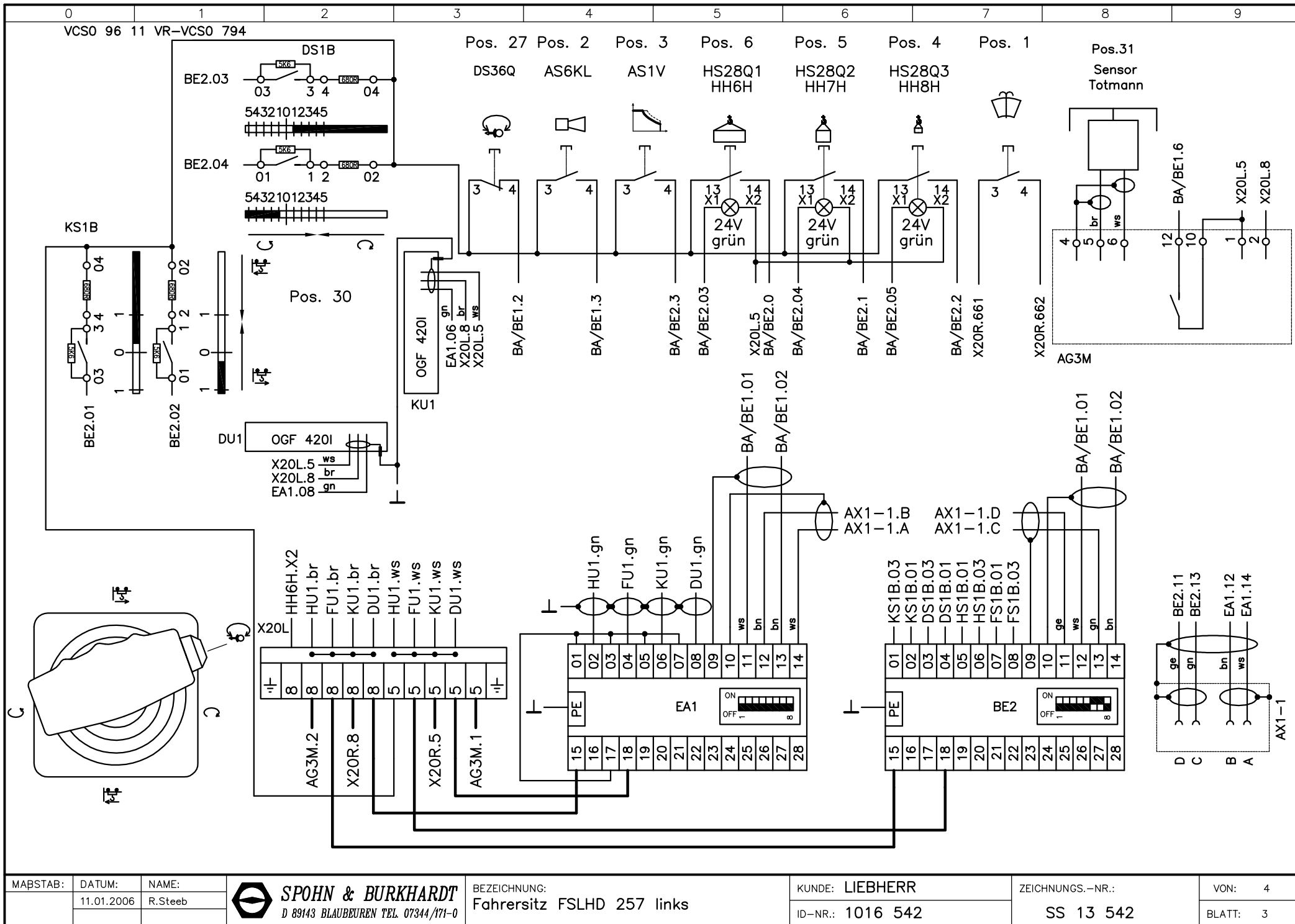

MAßSTAB: DATUM: NAME:
11.01.2006 R.Steeb

SPOHN & BURKHARDT
D 89143 BLAUBEUREN TEL. 07344/171-0

BEZEICHNUNG:
Fahrersitz FSLHD 257 links

KUNDE: LIEBHERR
ID-NR.: 1016 542

ZEICHNUNGS.-NR.:
SS 13 542

VON: 4
BLATT: 3

