



Turmstücke

Tower sections / Eléments de mât

Grundturmstück 6,85 m Base tower section Elément de mât de base	B 1
Turmstück 10,00 m Tower section Elément de mât	B 3
Turmstück 5,0 m Tower section Elément de mât	B 5
Turmstück 2,5 m Tower section Elément de mât	B 7
Turmstück 12,5 m Tower section Elément de mât	B 8
Grundturmstück 10,0 m Base tower section Elément de mât de base	B 10

Grundturmstück 6,85m
Base tower section /
Élément de mât de base

Bestell-Nr. : 9571 002 01
order no.
no. de comm.

Zelchnungs-Nr. : C 041.002 - 337.000
drawing no.
plan no.

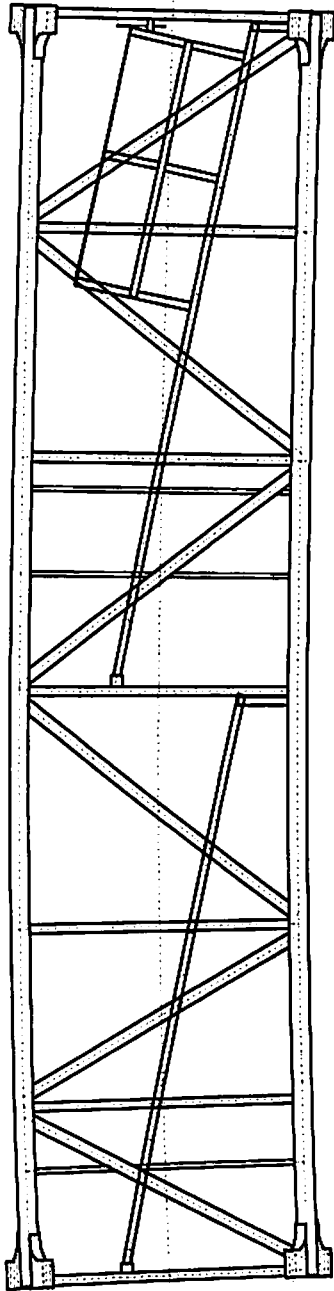

- 2
- 3
- 4
- 5
- 6

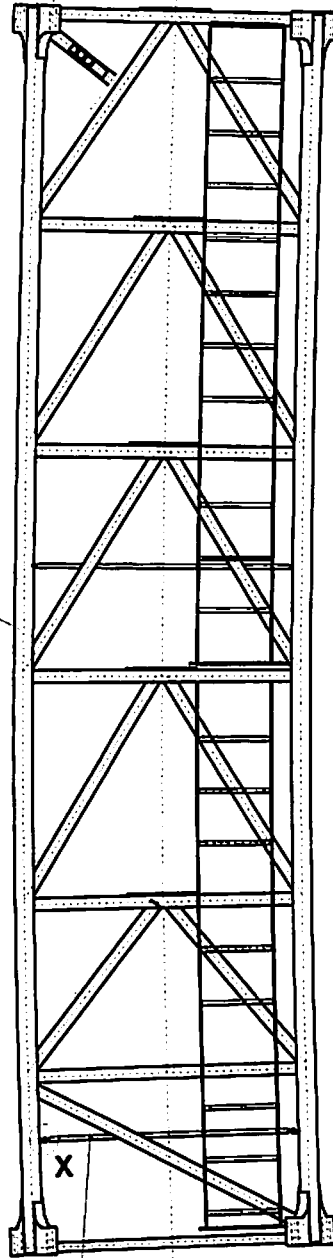

1

7



Einzelheit: X
detail / détail

- 8
- 9
- 10
- 11

Teil-Nr. part-no. pièce no	Bestell-Nr. order no. no. de comm.	Teilbenennung designation désignation	Anz. qty. nbre	Zeichnungs-Nr. drawing no. plan no.
1	9571 003 01	Turmstück tower section / élément de mât	1	C 041.002 - 337.111
2	4062 904 01	Schraube M 36x390 ISO 4014-12.9 bolt / boulon	8	Liebherr-Norm 31
3	4115 183 01	Mutter M 36 ISO 4033-12 nut / écrou	8	Liebherr-Norm 32
4	4215 040 01	Scheibe 37 DIN 6916 washer / rondelle	16	
5	9508 128 01	Distanzhülse spacing jacket / douille d'écartement	8	C 010.030 - 331.116
6	7790 140 01	Schutzkappe EP 800 / M 36 protecting cap / capot de protection	8	
7	9571 134 01	Geländerrohr railing pipe / tuyau de garde-corps	2	C 041.002 - 336.111 / 151
8	4065 071 01	Schraube M 8x25 ISO 4017-8.8 bolt / boulon	4	
9	4115 080 01	Mutter M 8 ISO 4032-8 nut / écrou	4	
10	4200 012 01	Scheibe 8,4 DIN 125-St washer / rondelle	4	
11	4239 014 01	Sicherungsscheibe VS 8 lock washer / rondelle d'arrêt	4	

Turmstück 10,00 m
Tower section / Élément de mât

Bestell-Nr. : 9571 351 01
order no.
no. de comm.

Zeichnungs-Nr. : C 041.002 - 331.000
drawing no.
plan no.

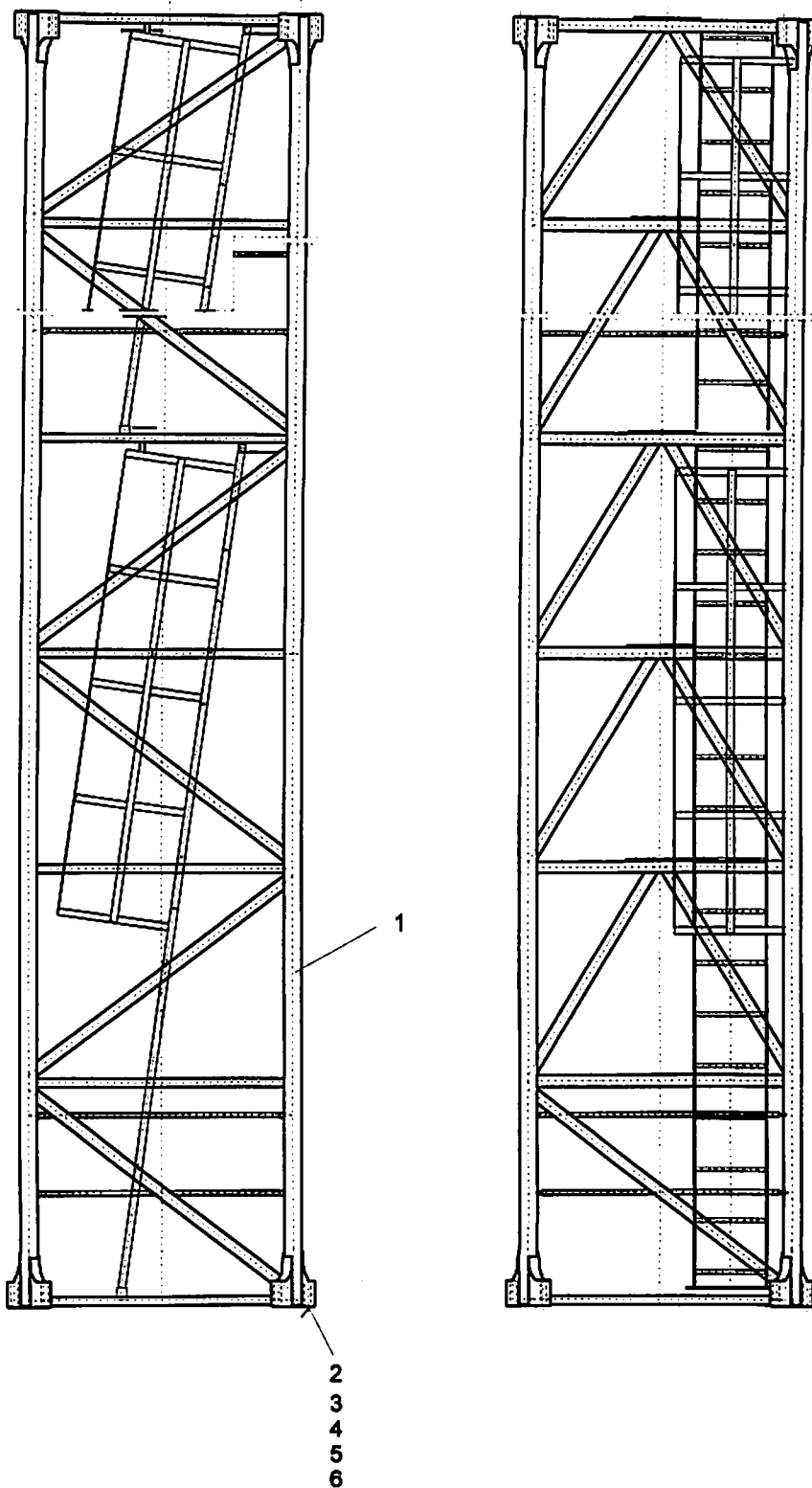

Teil-Nr. part-no. pièce no	Bestell-Nr. order no. no. de comm.	Teilbenennung designation désignation	Anz. qty. nbre	Zeichnungs-Nr. drawing no. plan no.
1	9571 352 01	Turmstück tower section / élément de mât	1	C 041.002 - 331.111
2	4062 904 01	Schraube M 36x390 ISO 4014-12.9 bolt / boulon	8	Liebherr-Norm 31
3	4115 183 01	Mutter M 36 ISO 4033-12 nut / écrou	8	Liebherr-Norm 32
4	4215 040 01	Scheibe 37 DIN 6916 washer / rondelle	16	
5	9508 128 01	Distanzhülse spacing jacket / douille d'écartement	8	C 010.030 - 331.116
6	7790 140 01	Schutzkappe EP 800 / M 36 protecting cap / capot de protection	8	

Turmstück 5,00 m
Tower section / Élément de mât

Bestell-Nr. : 9571 358 01
order no.
no. de comm.

Zeichnungs-Nr. : C 041.003 - 332.000
drawing no.
plan no.

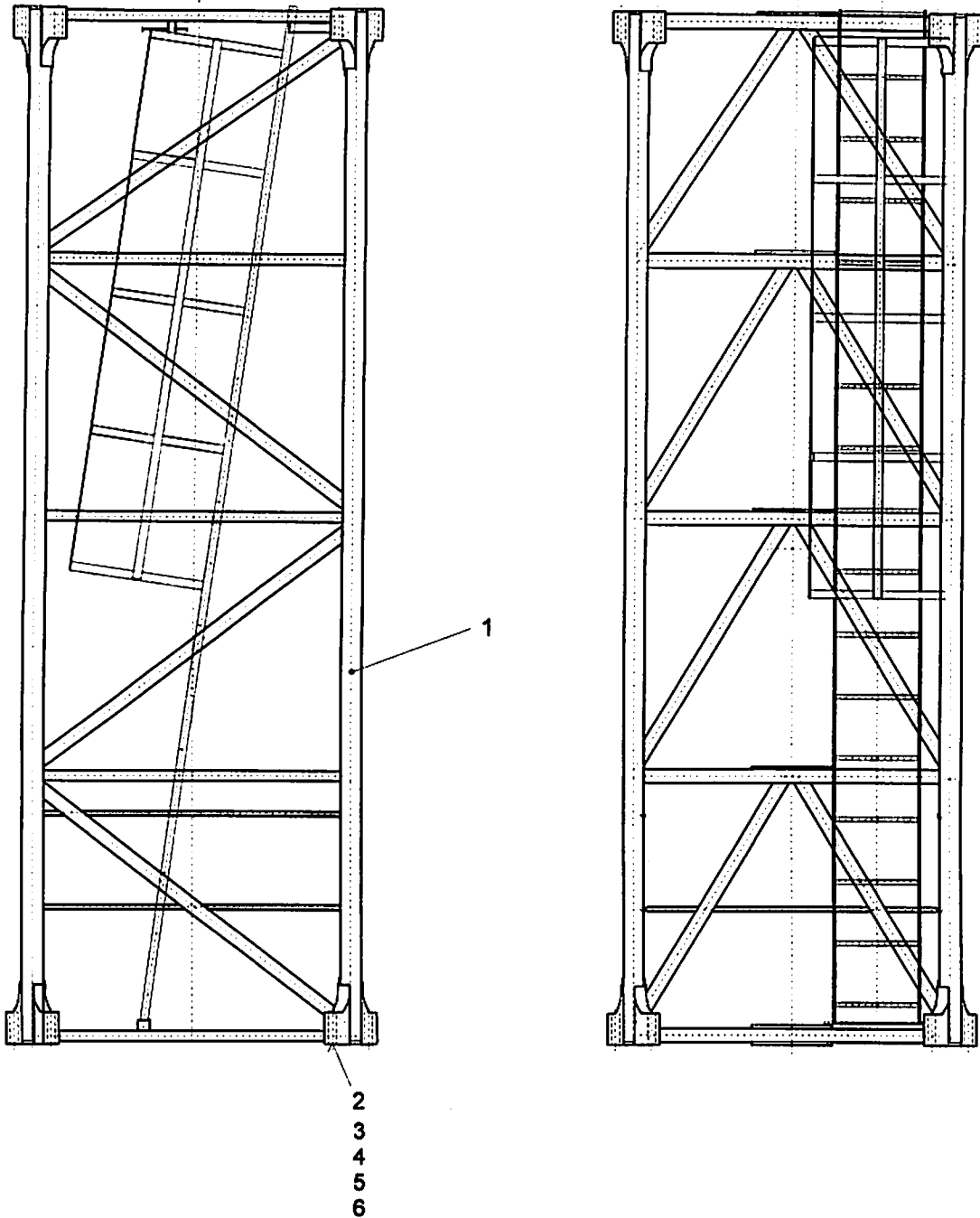

Teil-Nr. part-no. pièce no	Bestell-Nr. order no. no. de comm.	Teilbenennung designation désignation	Anz. qty. nbre	Zeichnungs-Nr. drawing no. plan no.
1	9571 359 01	Turmstück tower section / élément de mât	1	C 041.003 - 332.111
2	4062 904 01	Schraube M 36x390 ISO 4014-12.9 bolt / boulon	8	Liebherr-Norm 31
3	4115 183 01	Mutter M 36 ISO 4033-12 nut / écrou	8	Liebherr-Norm 32
4	4215 040 01	Schelbe 37 DIN 6916 washer / rondelle	16	
5	9508 128 01	Distanzhülse spacing jacket / douille d'écartement	8	C 010.030 - 331.116
6	7790 140 01	Schutzkappe EP 800 / M 36 protecting cap / capot de protection	8	

Turmstück 2,5 m
Tower section / Élément de mât

Bestell-Nr. : 9571 325 01
order no.
no. de comm.

Zeichnungs-Nr. : C 041.002 - 332.000
drawing no.
plan no.

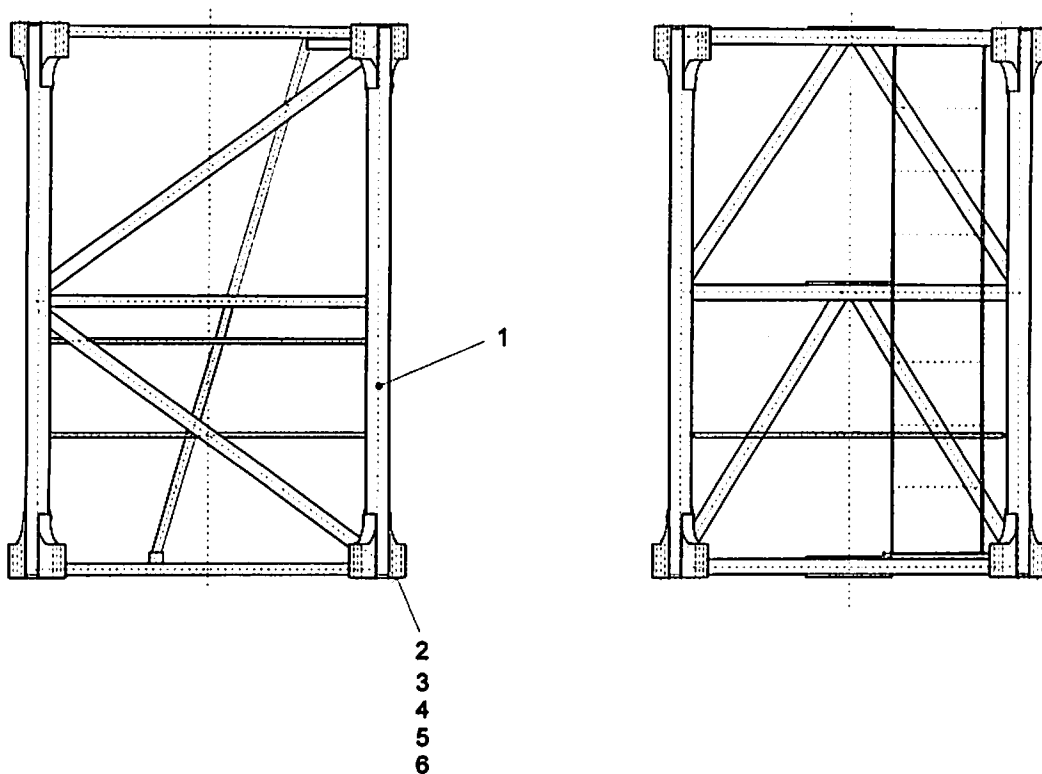

Teil-Nr. part no. pièce no	Bestell-Nr. order no. no. de comm.	Teilbenennung designation désignation	Anz. qty. nbre	Zeichnungs-Nr. drawing no. plan no.
1	9571 326 01	Turmstück tower section / élément de mât	1	C 041.002 - 332.111
2	4062 904 01	Schraube M 36x390 ISO 4014-12.9 bolt / boulon	8	Liebherr-Norm 31
3	4115 183 01	Mutter M 36 ISO 4033-12 nut / écrou	8	Liebherr-Norm 32
4	4215 040 01	Scheibe 37 DIN 6916 washer / rondelle	16	
5	9508 128 01	Distanzhülse spacing jacket / douille d'écartement	8	C 010.030 - 331.116
6	7790 140 01	Schutzkappe EP 800 / M 36 protecting cap / capot de protection	8	

Turmstück 12,5 m
Tower section / Élément de mât

Bestell-Nr. : 9578 298 01
order no.
no. de comm.

Zeichnungs-Nr. : C 041.003 - 331.000
drawing no.
plan no.

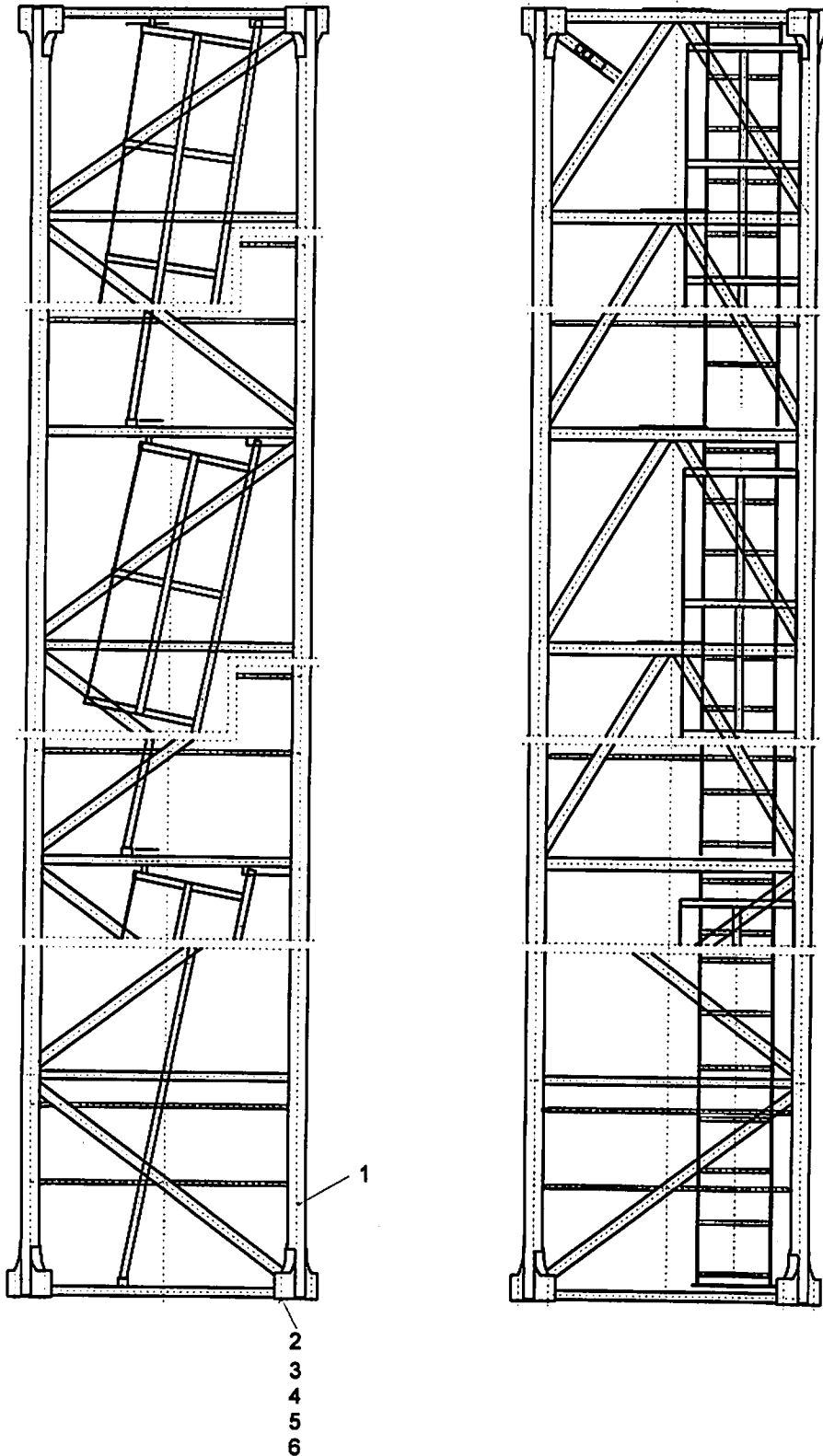

Teil-Nr. part-no. pièce no	Bestell-Nr. order no. no. de comm.	Teilbenennung designation désignation	Anz. qty. nbre	Zeichnungs-Nr. drawing no. plan no.
1	9578 299 01	Turmstück tower section / élément de mât	1	C 041.003 - 331.111
2	4062 904 01	Schraube M 36x390 ISO 4014-12.9 bolt / boulon	8	Liebherr-Norm 31
3	4115 183 01	Mutter M 36 ISO 4033-12 nut / écrou	8	Liebherr-Norm 32
4	4215 040 01	Scheibe 37 DIN 6916 washer / rondelle	16	
5	9508 128 01	Distanzhülse spacer / douille d'écartement	8	
6	7790 140 01	Schutzkappe EP 800 M 36 protecting cap / capot de protection	8	

Grundturmstück 10,0 m
Base tower section / Élément de mât de base

Bestell-Nr. : 9571 298 01
order no.
no. de comm.

Zeichnungs-Nr. : C 041.002 - 338.000
drawing no.
plan no.

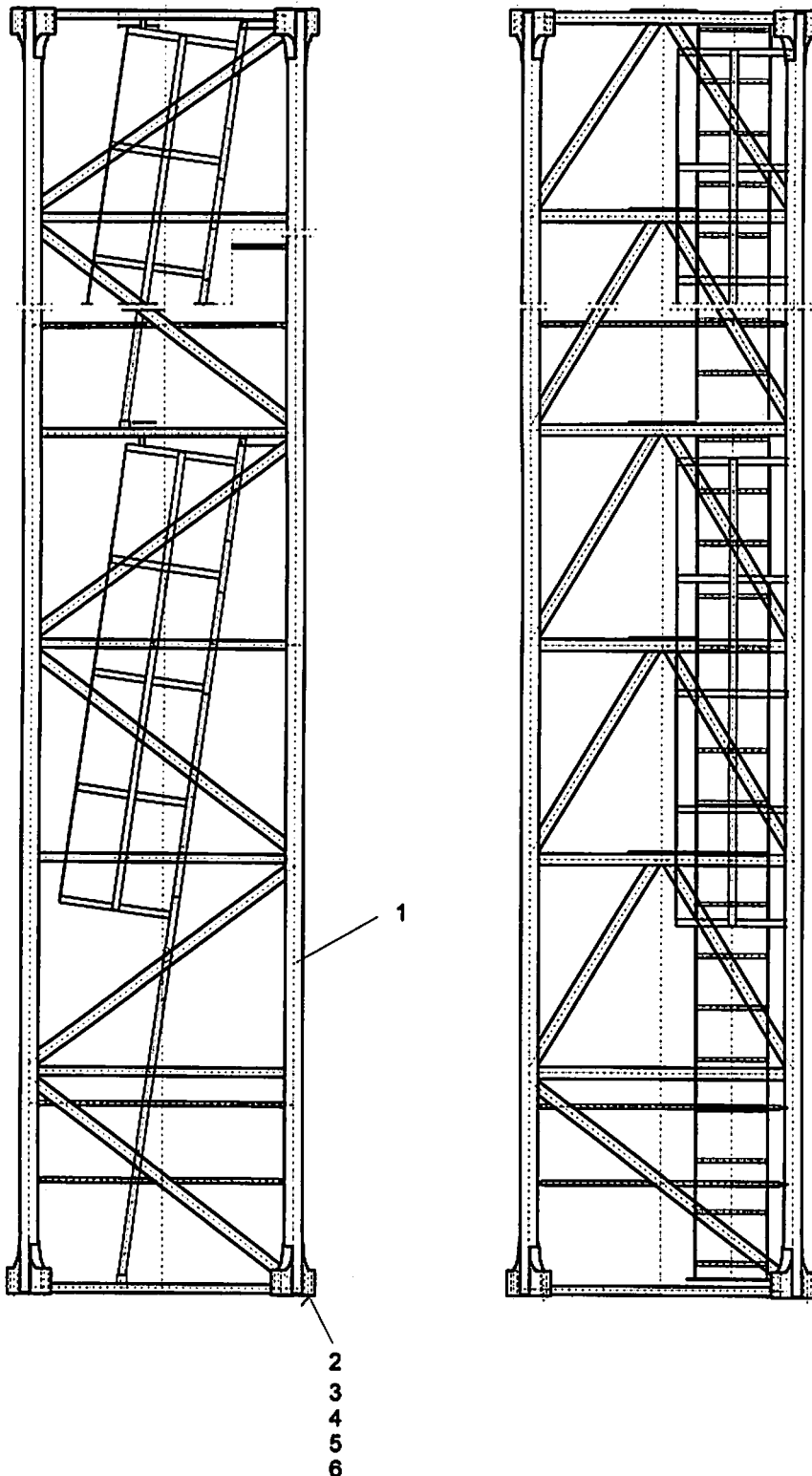

Teil-Nr. part-no. pièce no	Bestell-Nr. order no. no. de comm.	Teilbenennung designation désignation	Anz. qty. nbre	Zeichnungs-Nr. drawing no. plan no.
1	9571 299 01	Turmstück tower section / élément de mât	1	C 041.002 - 338.111
2	4062 904 01	Schraube M 36x390 ISO 4014-12.9 bolt / boulon	16	Liebherr-Norm 31
3	4115 183 01	Mutter M 36 ISO 4033-12 nut / écrou	16	Liebherr-Norm 32
4	4215 040 01	Scheibe 37 DIN 6916 washer / rondelle	32	
5	9508 128 01	Distanzhülse spacer / douille d'écartement	16	C 010.030 - 331.116
6	7790 140 01	Schutzkappe EP 800 / M 36 protecting cap / capot de protection	16	