

Z
 siehe Blatt 4
 see sheet 4
 voir feuille 4
 vedi foglio 4
 véase hoja 4

siehe Blatt 3
 see sheet 3
 voir feuille 3
 vedi foglio 3
 véase hoja 3

Y

siehe Blatt 2
 see sheet 2
 voir feuille 2
 vedi foglio 2
 véase hoja 2

X

111

Achtung!
 Schlitzzposition hier!
 Caution!
 Position of the slot here!
 Attention!
 Position de la fente ici !

137 136

Abstand zwischen Halter (Pos. 136) und Trommelflansch mit Schrauben (Pos. 137) auf 5 mm einstellen.
 Set the distance between retainer (pos. 136) and drum flange with bolts (pos. 137) to 5 mm.
 Régler la distance entre le support (pos. 136) et le flasque de tambour à 5 mm à l'aide des boulons (pos. 137).

eingebaut ab Serie ...
 installed from series ...
 installé(e) à partir de la série ...

A 120.001 - 611.000 / BI.1 (0.0)

308809

23.4.2012
 308809

LIEBHERR

**GESAMTLISTE
 OVERALL SURVEY
 AUSLEGERANLENKSTUECK
 JIB PIVOTING SECTION**

320 (1/6)

90 02 664 4

SCHALTSCHRANK S1
 SWITCHGEAR CABINET / ARMOIRE ÉLECTRIQUE / QUADRO ELETTRICO /
 ARMARIO ELÉCTRICO / РАСПРЕДШКАФ

Klemmkasten X2
 terminal box / boîte de bornes / scatola morsettiera
 caja de bornes / коробка клеммная

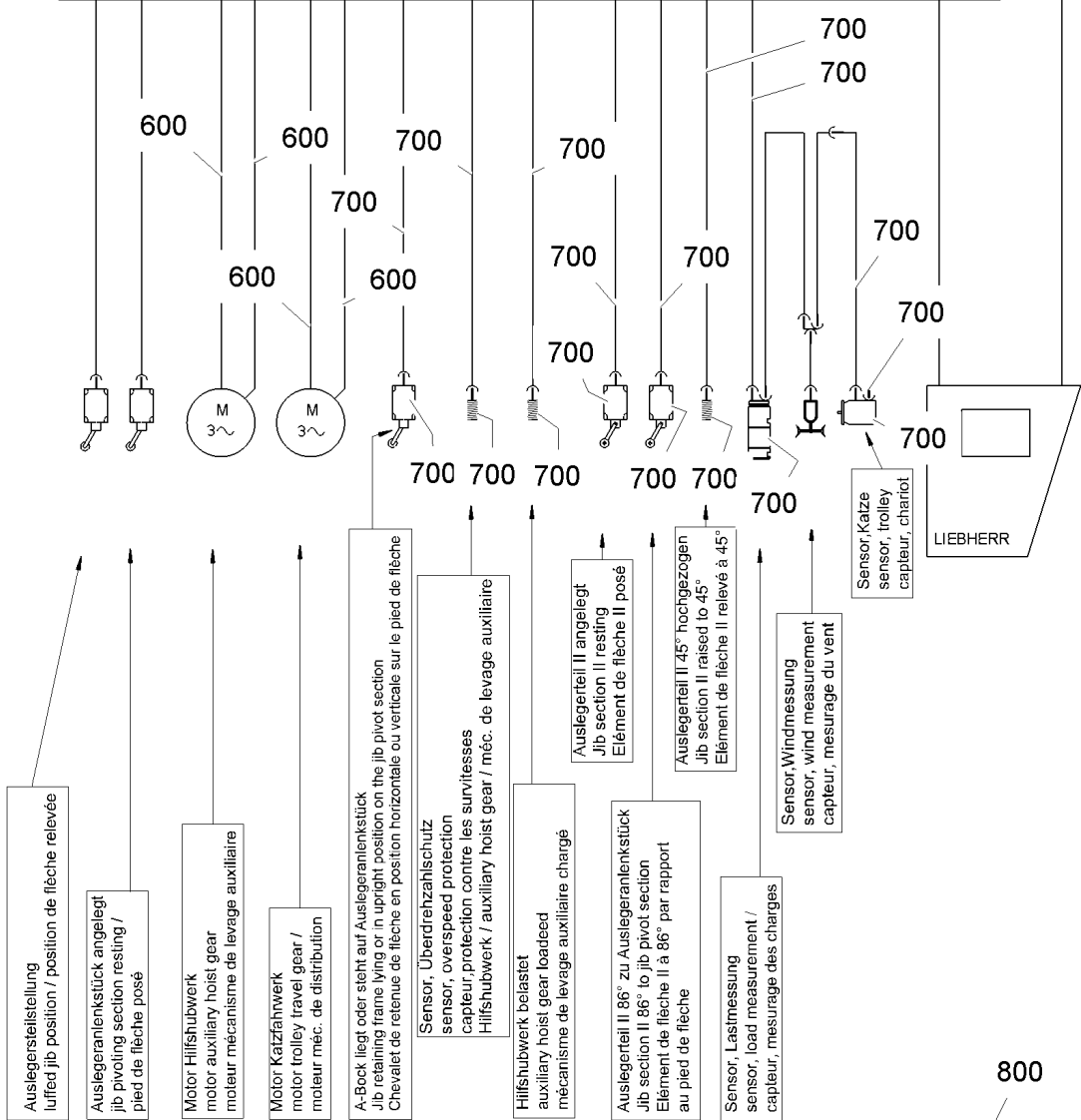

Auslegerstellstellung
 luffed jib position / position de flèche relevée

Auslegerankenstück angelegt
 jib pivoting section resting /
 pied de flèche posé

Motor Hilfshubwerk
 motor auxiliary hoist gear
 moteur mécanisme de levage auxiliaire

Motor Katzfahwerk
 motor trolley travel gear /
 moteur mec. de distribution

A-Back liegt oder steht auf Auslegerankenstück
 Jib retaining frame lying or in upright position on the jib pivot section
 Chevalet de retenue de flèche en position horizontale ou verticale sur le pied de flèche

Sensor, Überdrehzahlenschutz
 sensor, overspeed protection
 capteur, protection contre les survitesses
 Hilfshubwerk / auxiliary hoist gear / mec. de levage auxiliaire

Hilfshubwerk belastet
 auxiliary hoist gear loaded
 mécanisme de levage auxiliaire chargé

Auslegerenteil II 86° zu Auslegerankenstück
 Jib section II 86° to jib pivot section
 Élément de flèche II à 86° par rapport
 au pied de flèche

Auslegerenteil II angelegt
 Jib section II resting
 Élément de flèche II posé

Auslegerenteil II 45° hochgezogen
 Jib section II raised to 45°
 Élément de flèche II relevé à 45°

Sensor, Lastmessung
 sensor, load measurement /
 capteur, mesurage des charges

Sensor, Windmessung
 sensor, wind measurement
 capteur, mesurage du vent

Sensor, Katze
 sensor, trolley
 capteur, charriot

LIEBHERR

800
 Elektroinstallation Ausleger - Kleinteile / Befestigungsmaterial
 electric installation, jib - small parts / fastening elements
 installation électrique, flèche - petites pièces / éléments de fixation
 installazione elettrica, braccio - pezzi piccoli / materiale di fissaggio
 instalación eléctrica, pluma - piezas pequeñas / material de fijación
 электроинсталляция, стрела - прочие изделия / крепёжный материал

Elektroinstallation Ausleger 81K
 electric installation, jib
 installation électrique, flèche
 installazione elettrica, braccio
 instalación eléctrica, pluma
 электроинсталляция, стрела
 A 120.800 - 611.000

308006

23.4.2012
 308006

LIEBHERR

**GESAMTLISTE
 OVERALL SURVEY
 E-INST. AUSLEGER
 ELECTRIC INSTALLATION JIB**

358 (1/2)

90 01 499 6

Pos.	Artikel	Menge	Bezeichnung	Description	Serie
600	90014997	1	E-INST. AUSLEGER ⇒  360	ELECTRIC INSTALLATION JIB	
700	90014998	1	E-INST. AUSLEGER ⇒  363	ELECTRIC INSTALLATION JIB	
800	90014999	1	E-INST. AUSLEGER ⇒  367	ELECTRIC INSTALLATION JIB	

<p>23.4.2012</p> <p>LIEBHERR</p>	<p>GESAMTLISTE OVERALL SURVEY E-INST. AUSLEGER ELECTRIC INSTALLATION JIB</p>	<p> 359 (2/2)</p> <p>90 01 499 6</p>
---	--	---

SCHALTSCHRANK S1
 SWITCHGEAR CABINET / ARMOIRE ÉLECTRIQUE / QUADRO ELETTRICO /
 ARMARIO ELÉCTRICO / РАСПРЕДШКАФ

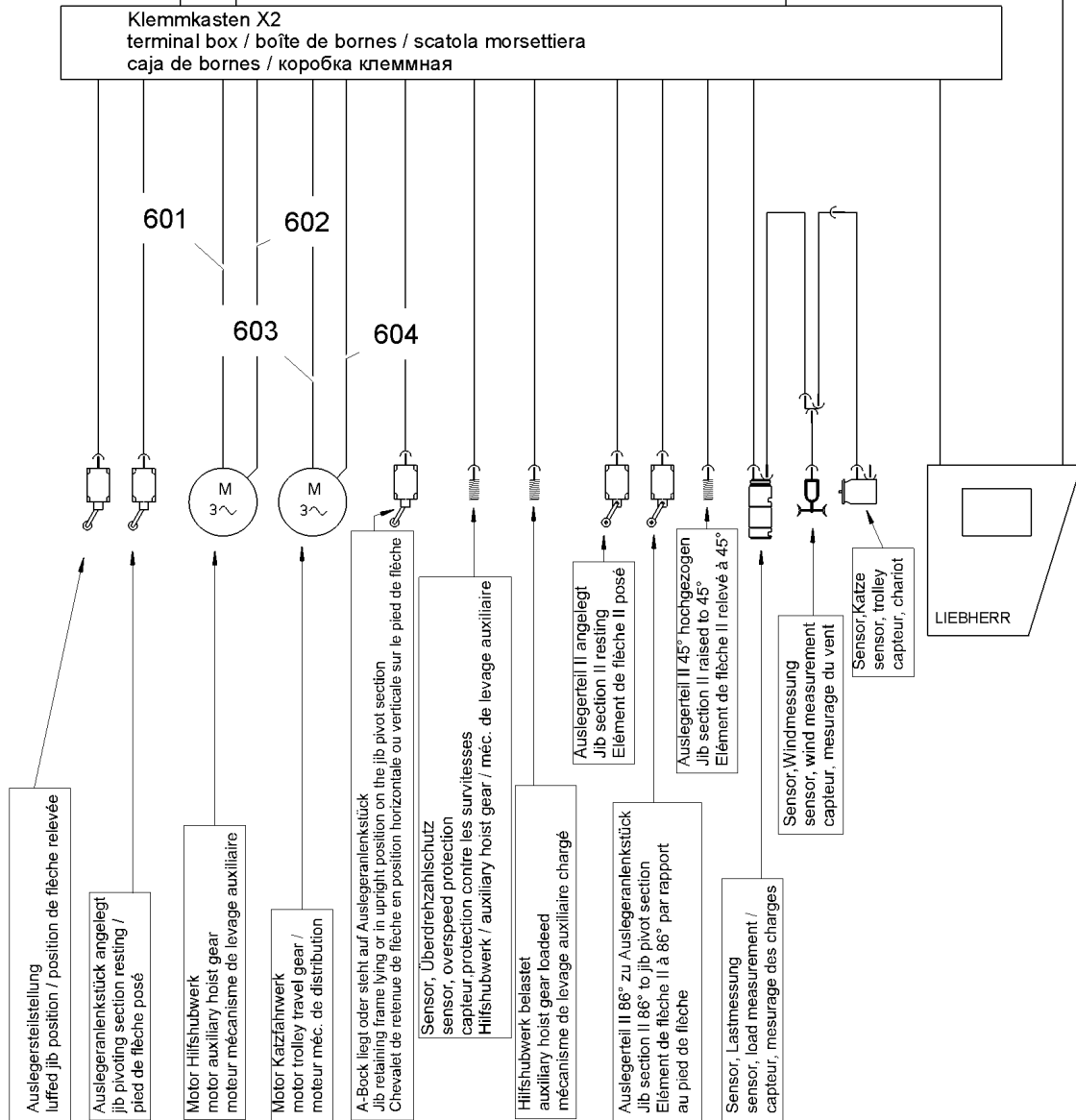

Elektroinstallation Ausleger 81K - Leitungen KAW / HHW

electric installation, jib - lines
 installation électrique, flèche - lignes
 installazione elettrica, braccio - lineas
 instalación eléctrica, pluma - lineas
 электроинсталляция, стрела - линии / кабели
 A 120.800 - 611.600 / Bl.1 (1.0)

308007

23.4.2012
 308007

LIEBHERR

**GESAMTLISTE
 OVERALL SURVEY
 E-INST. AUSLEGER
 ELECTRIC INSTALLATION JIB**

360 (1/3)

90 01 499 7

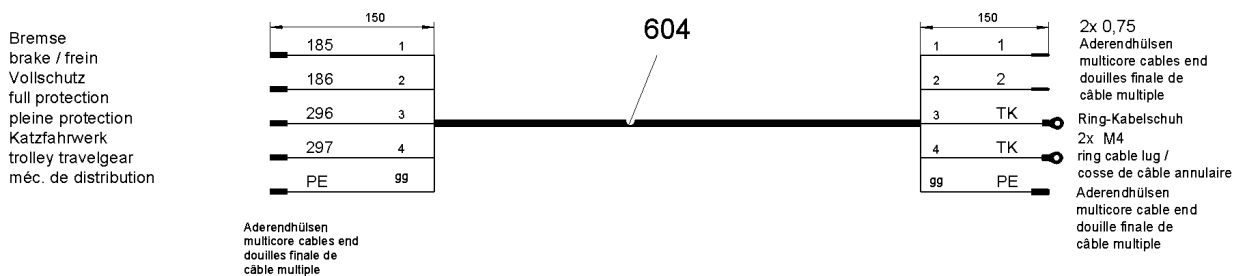
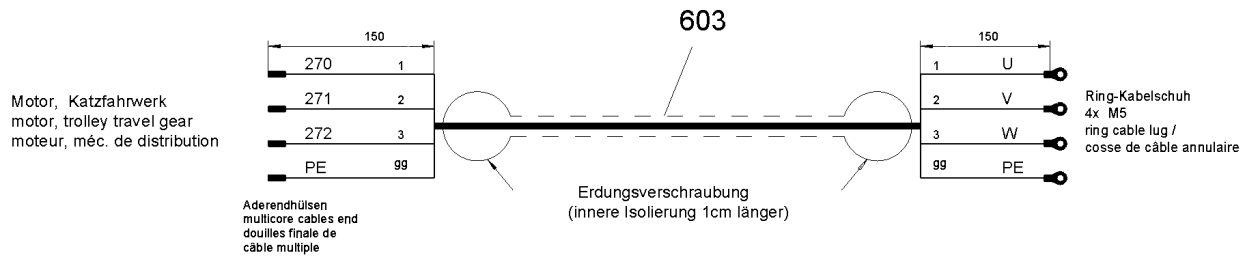
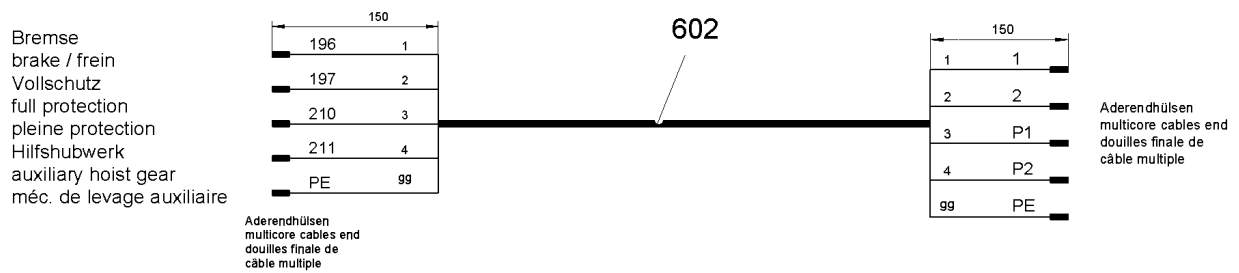
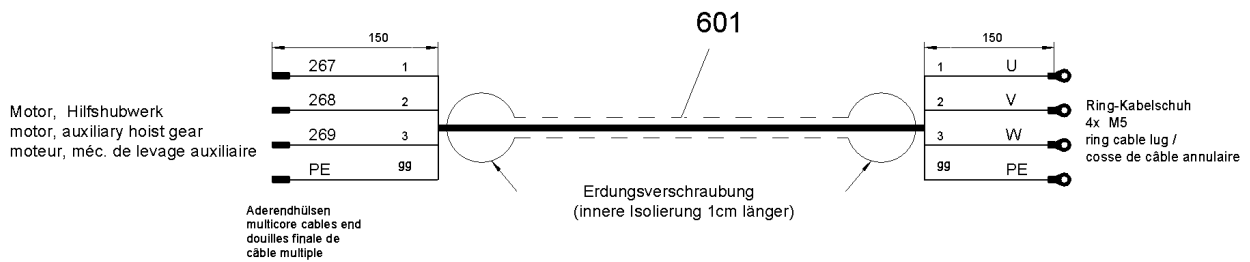

Elektroinstallation Ausleger 81K - Leitungen KAW / HHW

electric installation, jib - lines
installation électrique, flèche - lignes
installazione elettrica, braccio - lineas
instalación eléctrica, pluma - lineas
электромонтаж, стрела - линии / кабели
A 120.800 - 611.600 / Bl. 2 (1.0)

308008

23.4.2012
308008

LIEBHERR

**GESAMTLISTE
OVERALL SURVEY
E-INST. AUSLEGER
ELECTRIC INSTALLATION JIB**

361 (2/3)

90 01 499 7

Pos.	Artikel	Menge	Bezeichnung	Description	Serie
601	10176137	6.7m	LEITUNG 4G 2,5mm ² ABGESCHIRMT	LEAD	
602	600236301	6.7m	LEITUNG 5G1,5mm ²	LEAD	20100701-
603	10176137	7.4m	LEITUNG 4G 2,5mm ² ABGESCHIRMT	LEAD	
604	600236301	7.4m	LEITUNG 5G1,5mm ²	LEAD	20110520-

SCHALTSCHRANK S1
 SWITCHGEAR CABINET / ARMOIRE ÉLECTRIQUE / QUADRO ELETTRICO /
 ARMARIO ELÉCTRICO / РАСПРЕДШКАФ

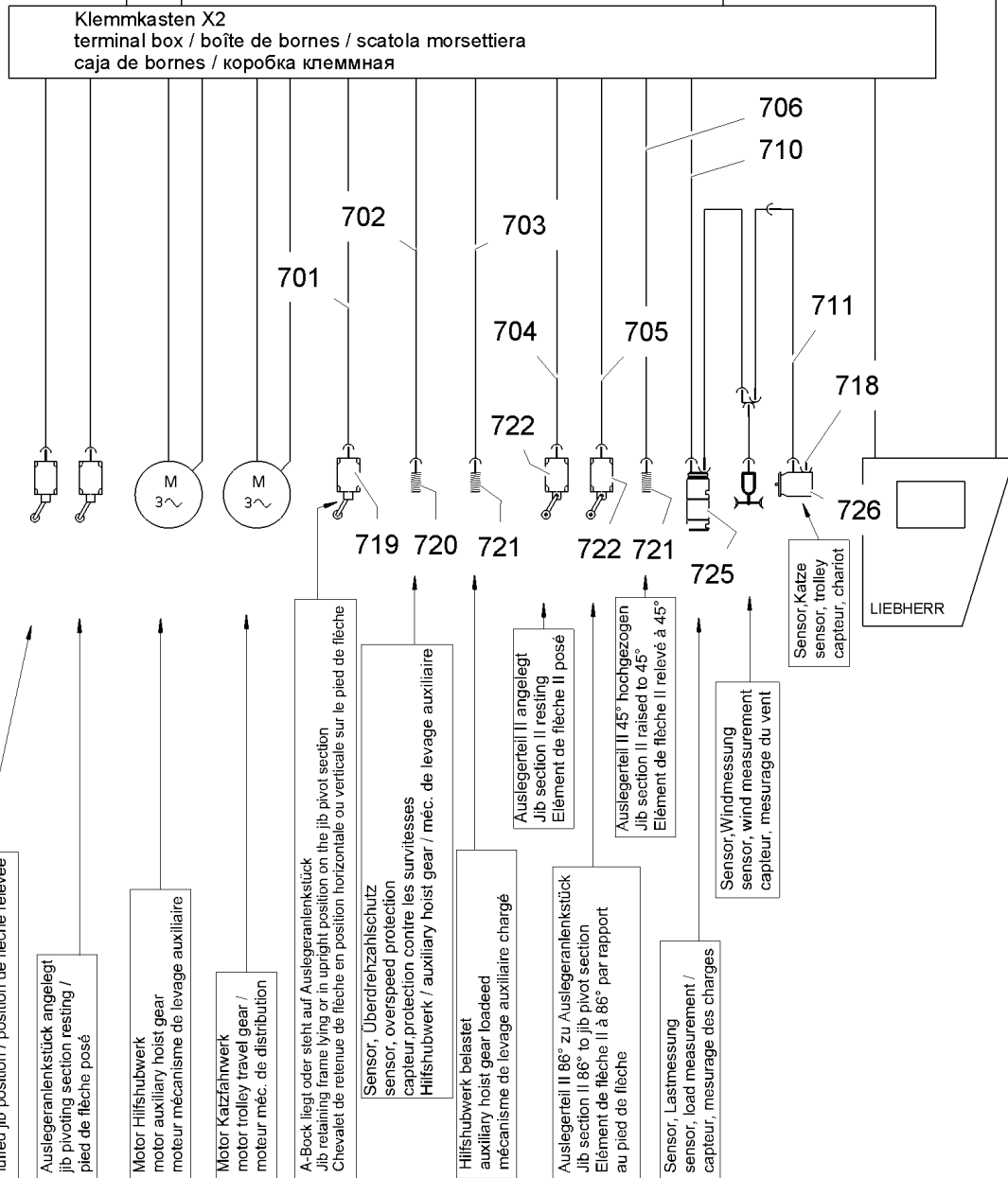

Elektroinstallation Ausleger 81K - Leitungen,Endschalter, Sensoren
 electric installation, jib - cables, limit switches, sensors
 installation électrique, flèche - lignes, interrupteurs de fin de course, détecteurs
 installazione elettrica, braccio - linee, interruttori finecorsa, sensori
 instalación eléctrica, pluma - líneas, interruptores de fin de carrera, sensores
 электроинсталляция, стрела - ел. проводка / кабели, концевые выключатели, датчики
 A 120.800 - 611.700 / Bl. 1

308011

23.4.2012
 308011

LIEBHERR

**GESAMTLISTE
 OVERALL SURVEY
 E-INST. AUSLEGER
 ELECTRIC INSTALLATION JIB**

363 (1/3)

90 01 499 8

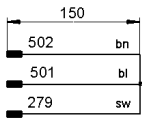

701

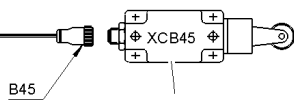

A-Bock liegt oder steht auf Auslegeranlenkstück
Jib retaining frame lying or in upright position
on the jib pivot section
Chevalet de retenue de flèche en position horizontale
ou verticale sur le pied de flèche

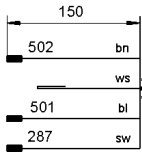

702

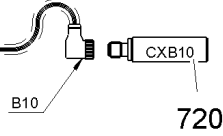

Überwachung Drehzahl - Montagewerk
monitoring slewing speed - erection gear /
surveillance vitesse de rotation -
mécan.de montage

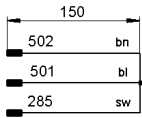

703

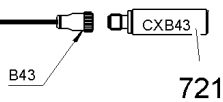

Hilfshubwerk belastet
auxiliary hoist gear loaded
mécanisme de levage auxiliaire chargé

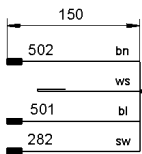

704

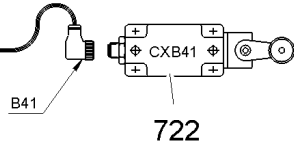

Auslegerteil II angelegt
Jib section II resting
Élément de flèche II posé

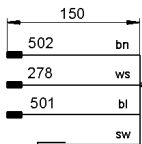

705

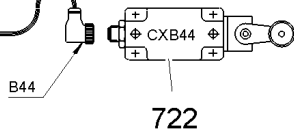

Auslegerteil II 86° zu Auslegeranlenkstück
Jib section II 86° to jib pivot section
Élément de flèche II à 86° par rapport
au pied de flèche

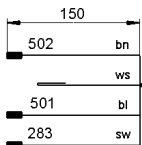

706

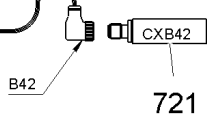

Auslegerteil II 45° hochgezogen
Jib section II raised to 45°
Élément de flèche II relevé à 45°

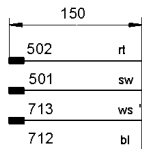

710

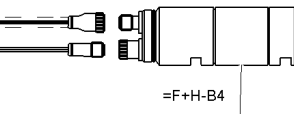

Sensor, Lastmessung
sensor, load measurement /
capteur, mesurage des charges

711

Code nach Schaltplan 4005-22461
code according to circuit diagram 4005-22461
code selon le schéma électrique 4005-22461

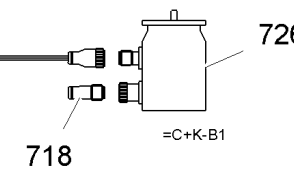

Sensor, Katze
sensor, trolley
capteur, chariot

Pos.	Artikel	Menge	Bezeichnung	Description	Serie
701	10045553	1	STECKVERBINDER 3 POL. 5m LANG	PLUG CONNECTOR	20100617-
702	10171938	1	STECKVERBINDER	PLUG CONNECTOR	20100617-
703	10045554	1	STECKVERBINDER 3 POL. 10m LANG	PLUG CONNECTOR	20100617-
704	10173730	1	STECKVERBINDER 4X0,34mm ² L=20m	PLUG CONNECTOR	20100318-
705	10173730	1	STECKVERBINDER 4X0,34mm ² L=20m	PLUG CONNECTOR	20100617-
706	10173730	1	STECKVERBINDER 4X0,34mm ² L=20m	PLUG CONNECTOR	20100617-
710	10171980	1	STECKVERBINDER	PLUG CONNECTOR	
711	10171967	1	STECKVERBINDER	PLUG CONNECTOR	
718	10171990	1	STECKER	PLUG	
719	10040126	1	ENDSCHALTER	LIMIT SWITCH	20100617-
720	10169346	1	INDUKTIVSENSOR	INDUCTIVE SENSOR	
721	10175031	2	INDUKTIVSENSOR	INDUCTIVE SENSOR	20101115-
722	10040125	2	ENDSCHALTER	LIMIT SWITCH	20100617-
726	90014945	1	KATZSENSOR	TROLLEY SENSOR	

⇒  366

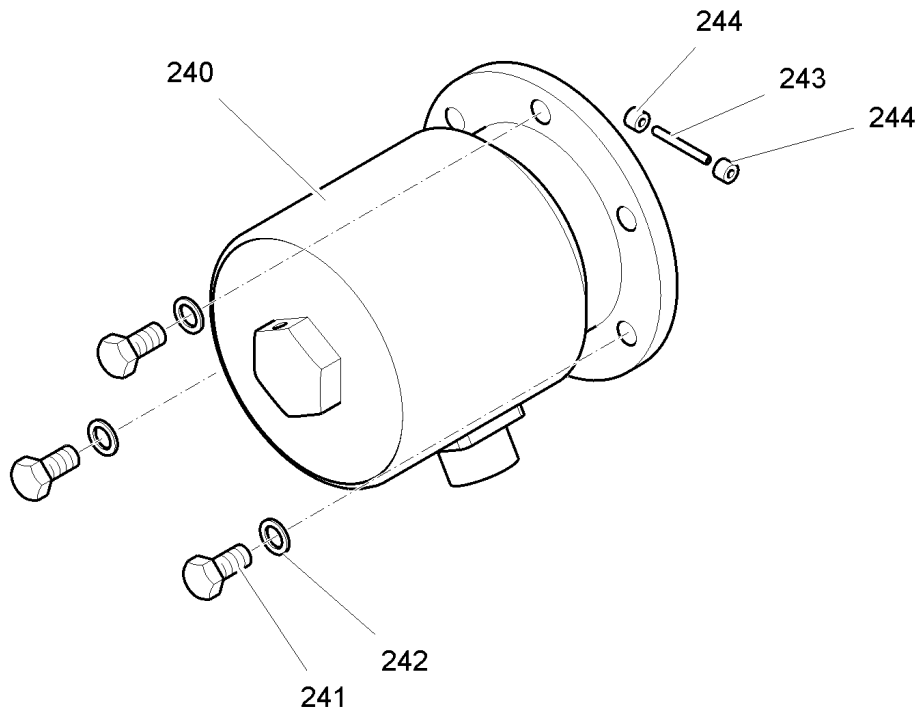

ELZ 020 AF 090 - 000

308038

Pos.	Artikel	Menge	Bezeichnung	Description	Serie
240	10171846	1	ABSOLUTWERTGEBER	ABSOLUTE VALUE TRANSDUCE	
241	4900188	3	SECHSKANTSCHRAUBE ISO 4017 M8x16 8.8 A2	HEX HEAD SCREW	
242	423910801	3	SICHERUNGSSCHEIBE 8,4/13X1,7 VS 8	LOCK WASHER	
243	432000901	1	SPANNSTIFT 3	DOWEL PIN	
244	774207801	0.012m	SCHLAUCH 7X3	HOSE	

23.4.2012
308038

LIEBHERR

GESAMTLISTE
OVERALL SURVEY
KATZSENSOR
TROLLEY SENSOR

366

90 01 494 5

OHNE BILD WITHOUT ILLUSTRATION SANS PLANCHE

Elektroinstallation Ausleger - Kleinteile / Befestigungsmaterial

electric installation, jib - small parts / fastening elements
 installation électrique, flèche - petites pièces / éléments de fixation
 installazione elettrica, braccio - pezzi piccoli / materiale de fissaggio
 instalación eléctrica, pluma - piezas pequeñas / material de fijación
 электроинсталляция, стрелы - прочие изделия / крепёжный материал
 A 120.800 - 611.800

308014

Pos.	Artikel	Menge	Bezeichnung	Description	Serie
801	404202701	2	ZYLINDERSCHRAUBE ISO 4762 M5x45 8.8 A2C	CYLINDER SCREW	
802	420000801	2	SCHEIBE 5	WASHER	
803	423910501	2	SICHERUNGSSCHEIBE 5,3/9X1,3 VS	LOCK WASHER	
804	932980801	1	BLECH 4X41X73	SHEET METAL	
805	7364927	46	KLEMMHAELFTE DIN 3015-1 L 0 R 6 PP SW	TOOL HOLDER	
806	602008014	2	KLEMMHAELFTE DIN 3015-1 L 2 R 14 PP SW	TOOL HOLDER	
810	4042002	23	ZYLINDERSCHRAUBE ISO 4762 M6x20 8.8 A2C	CYLINDER SCREW	
811	4042003	2	ZYLINDERSCHRAUBE ISO 4762 M6x25 8.8 A2C	CYLINDER SCREW	
815	975102301	2	ZUGENTLASTUNG	STRAIN RELIEF	
820	10045157	2	KABELVERSCHRAUBUNG	CABLE JOINT	20110428-
821	602440101	2	KABELVERSCHRAUBUNG	CABLE JOINT	
825	602620201	2	REDUZIERUNG M20 - M16	REDUCER	

23.4.2012
308014

LIEBHERR

**GESAMTLISTE
OVERALL SURVEY
E-INST. AUSLEGER
ELECTRIC INSTALLATION JIB**

 367

90 01 499 9