

INHALTSVERZEICHNIS

INDICE

FAW 50/63/71EC-B

Seite	Bezeichnung	erstellt	Name	Seite	Bezeichnung	erstellt	Name
-------	-------------	----------	------	-------	-------------	----------	------

1	SCHALTSCHRANK ARMARIO EL CTRICO	19.01.2006	KUGLER				
2	INHALTSVERZEICHNIS INDICE	23.01.2006	KUGLER				
3	EINSPEISUNG ALIMENTACIÖN	19.01.2006	KUGLER				
4	EINSPEISUNG ALIMENTACIÖN	19.01.2006	KUGLER				
5	BREMSE FRENO	19.01.2006	KUGLER				
6	STEUERSTAND PUESTO DE MANDO	19.01.2006	KUGLER				
7	STEUERUNG COMMANDO	19.01.2006	KUGLER				
8	FREQUENZUMRICHTER CONVERTIDOR DE FRECUENCIA	19.01.2006	KUGLER				
9	FREQUENZUMRICHTER CONVERTIDOR DE FRECUENCIA	19.01.2006	KUGLER				
10	GERÄTEANORDNUNG DISPOSICION DE LOS DISPOSITIVOS	19.01.2006	KUGLER				
11	KLEMMENPLAN ESQUEMA DE BORNES	23.01.2006	KUGLER				

LIEBHERG - WERK BIBERACH GMBH <small>Copyright (c)</small>		INHALTSVERZEICHNIS INDICE		Type FAW 50/63/71EC-B Zeich.-Nr. 4005-22074		Anlage: Ort Blatt 2 Artikel-Code: 969215501	
1	2	3	4	5	6	7	8

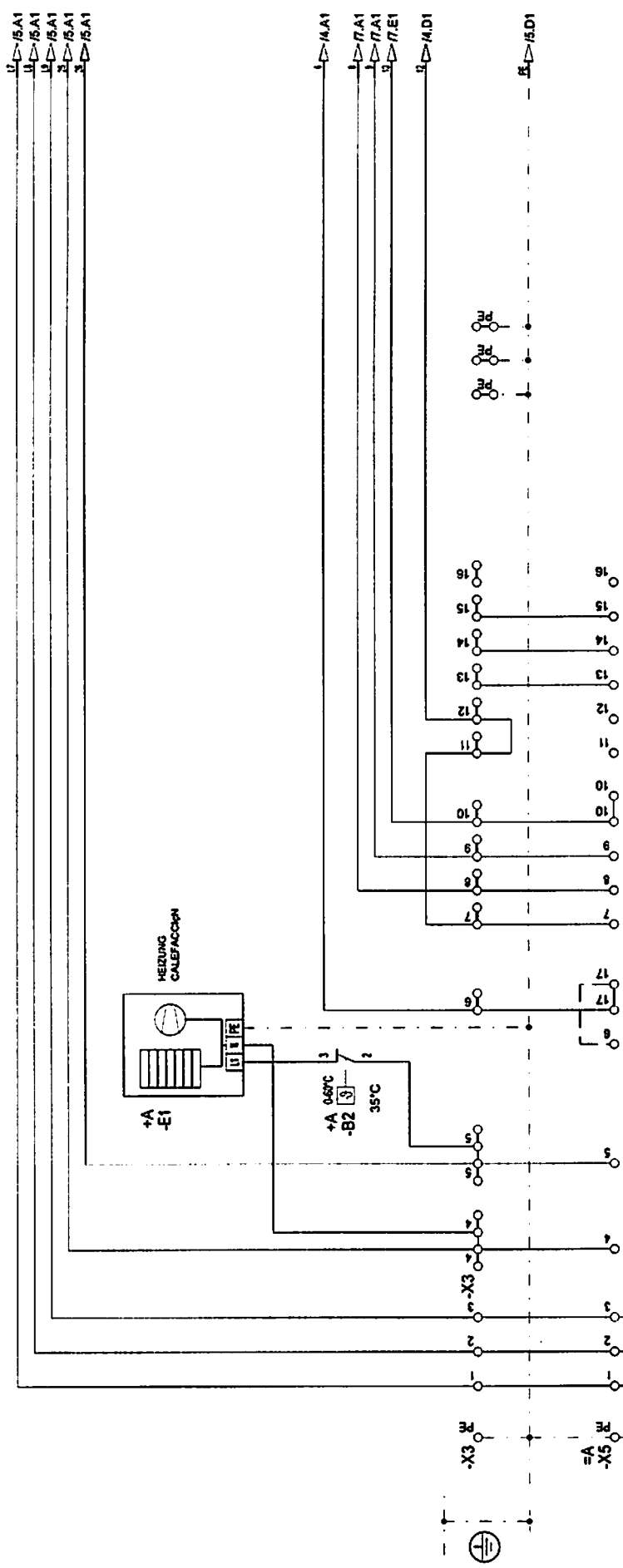

EINSTELLWERT
VALOR DE AJUSTE

Leistungsschalter

=S1
+F
-Q1

bei Inbetriebnahme
im S1 überprüfen!

Anlage: -S3		Type FAW 50/63/71EC-B		EINSPEISUNG ALIMENT		LIEBHERR - WERK EIBERACH GMBH		Copyright (c)	
Ort: Bad 3		Zsch-Nr. 4005-22074							
Artikel-Cod. -66215501									
Dz.	19.01.2006	RUCKLER							
Bez.									
Gez.	31.05.2006 08:13								
Datum									
Name									
Datum									
Name									

13.67

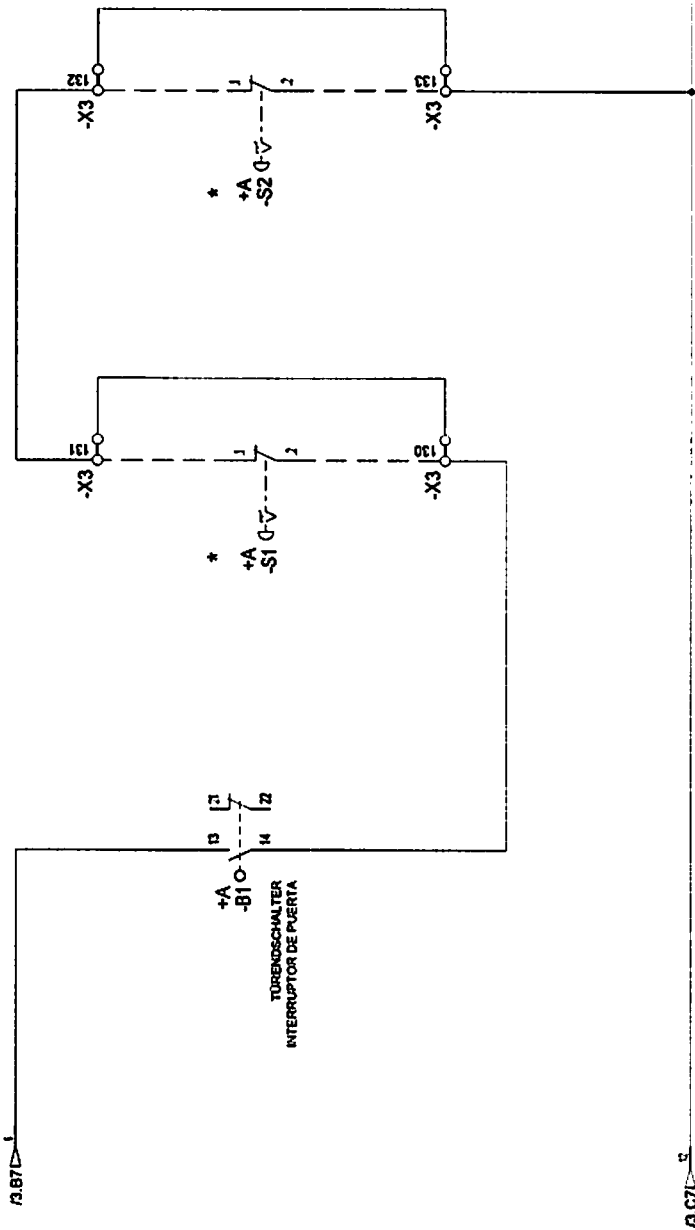

Anlage:	eS3
	Ort
Type	FAW 50/63/71EC-B
Zeich.-Nr.	4005-22074
EINSPEISUNG ALIMENTACION	
LIEBHERR - WERK BIBERACH GMBH	
Copyright (c)	
Gez.	19.01.2008
Bez.	
Gepr.	21.06.2008 06:13
Name	
Titel	
Datum	
Arbeits-	

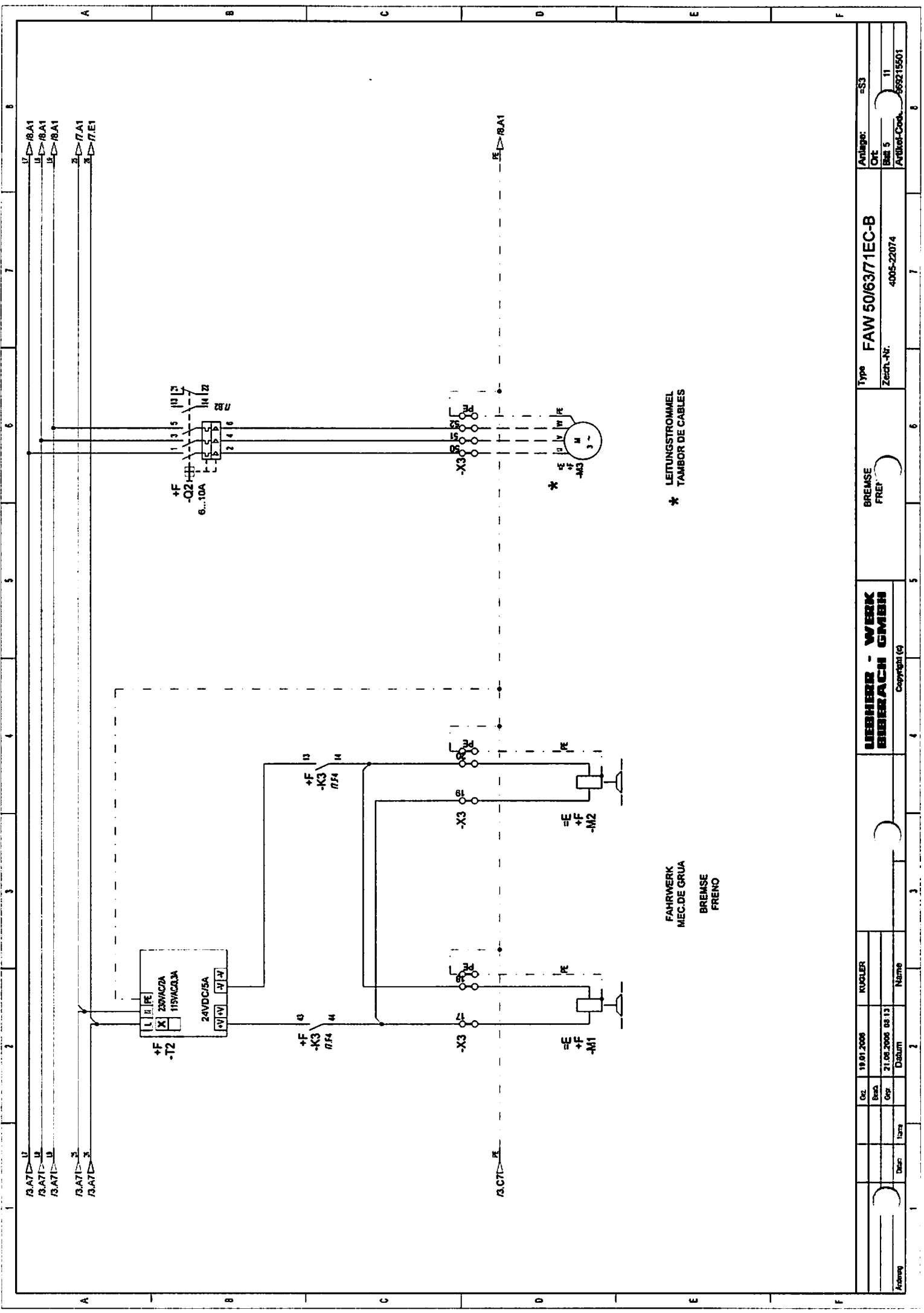

FAHRWERK
MEC.DE GRUA
BREMSE
FRENO

* LEITUNGSTROMMEL
* TAMBOR DE CABLES

Arbeits- Ort	19.01.2008		KUGLER	
	Dz	21.06.2008	08 13	Name
Type	FAW 50/63/71EC-B		LIEBHERR - WERK BIBERACH GMBH	
	4005-22074		Copyright (c)	
Arbeits- Code	=S3		BREMSE FRENO	
Arbeits- Code	11		Copyright (c)	
Arbeits- Code	69215501		Copyright (c)	

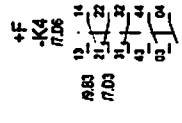
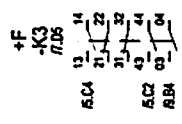
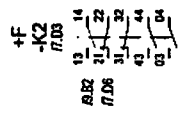
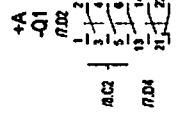
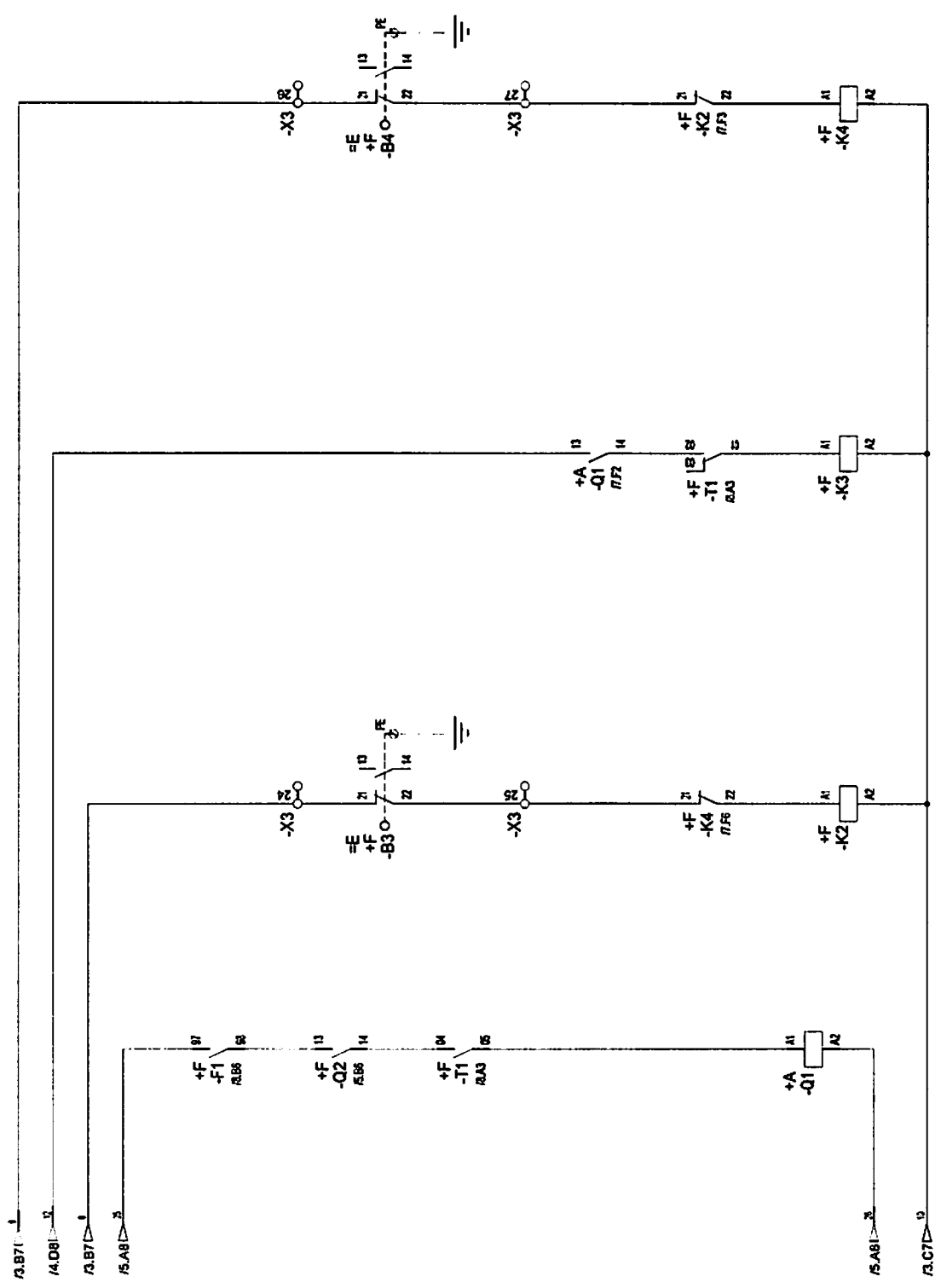

			Type FAW 50/63/71EC-B			Anlage: =S3		
			Zeich.-Nr. 4005-22074			Ort		
			4005-22074			Blatt 7		
			4005-22074			Arbeits-Cod. 69215501		
			LIEBHERR - WERK BIBBRACH GMBH			STEUERUNG		
			Copyright (c)			COMPA		
			KÜGLER			Name		
Dz. 19.01.2008			Dz.			Dz.		
21.08.2008 06.13			21.08.2008 06.13			21.08.2008 06.13		
Dz.			Dz.			Dz.		
Dz.			Dz.			Dz.		

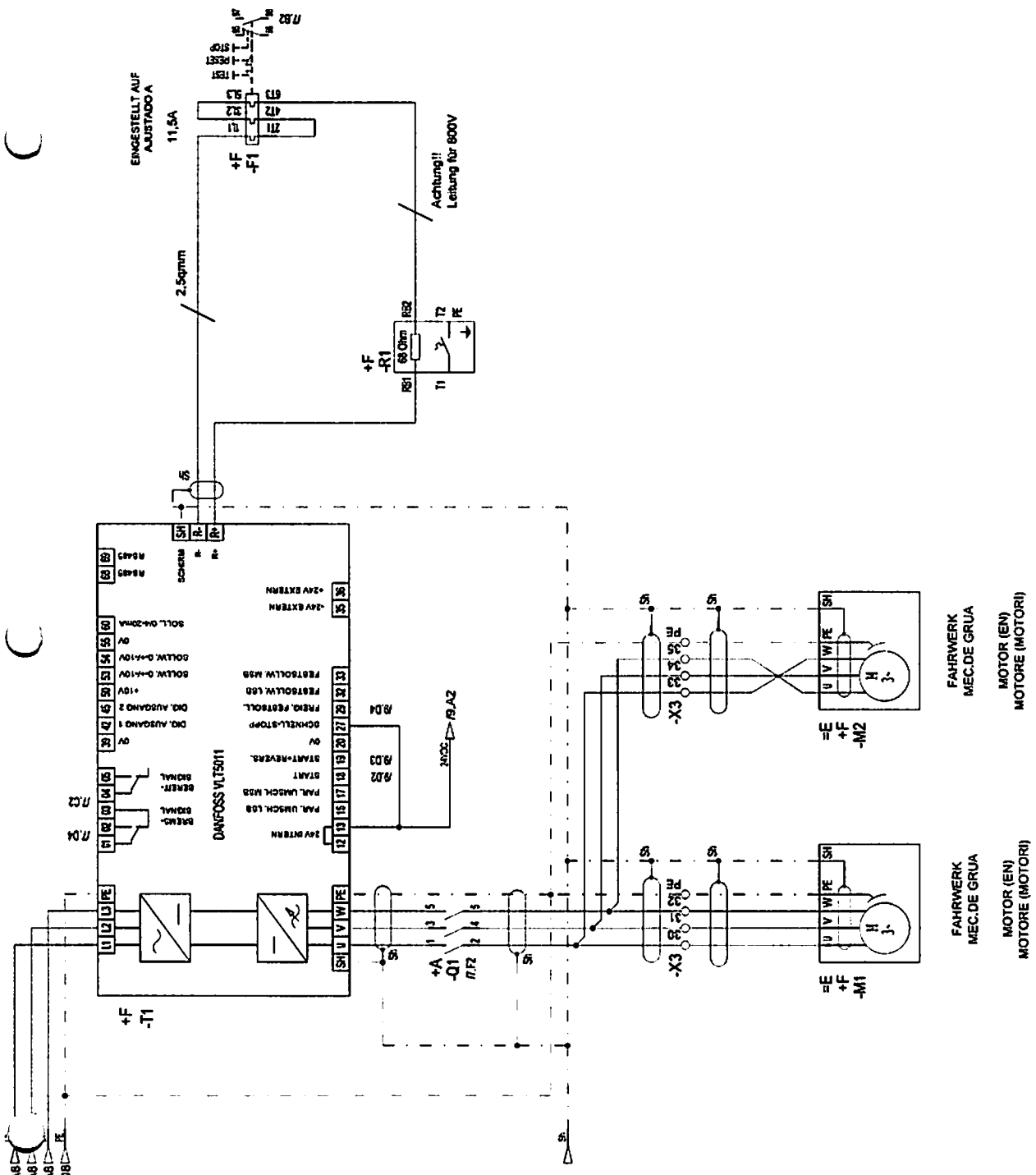

2

1

Art.-Nr.	FAW 50/63/71EC-B	Art.-Nr.	=53
Zeich.-Nr.	4005-22074	Ort	
Typ	FREQUENZUMRICHTER CONVERTIDOR DE FRECUENCIA	Blatt 0	von 11
Copyright (c)	LIEBHERER - WERK BIERBACH GMBH	Artikel-Code:	969215601
Art.-Nr.		Blatt 0	von 11
Zeich.-Nr.	4005-22074	Artikel-Code:	969215601

AB.C31 - 2000

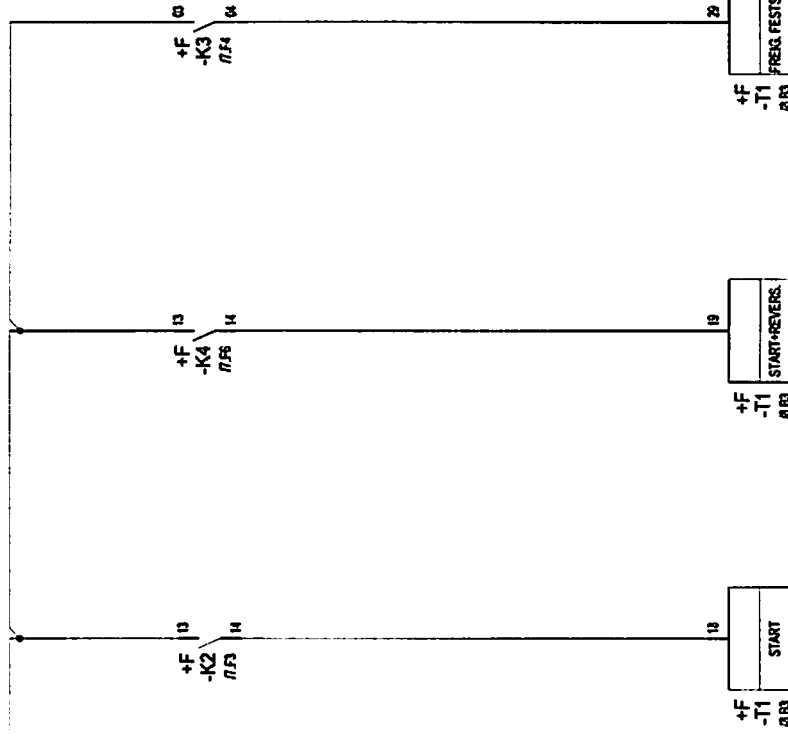

+F
-T1
R.B3
START

VORWAERTS
HACIA ADELANTE

+F
-T1
R.B3
START+REVERS.

RÜCKWAERTS
HACIA ATRAS

+F
-T1
R.B3
FREQ. FESTSOLL

REGLERSPERRE
BLOQUEO DEL REGULADOR

FREQUENZUMRICHTER
CONVERTIDOR DE FRECUENCIA

Abmessung	Gr.	19.01.2008	RUGLER	Type	FAW 50/63/71EC-B	Anlage: =S3
	Best.				Zeich.-Nr.	
Date	Gr.	21.08.2008	08.13	Zeich.-Nr.	4005-22074	Anlage: =S3
	Best.				Artik.-Code	
Name				Frequenzumrichter Convertidor de frecuencia		Blatt 9
Datum				Copyright (c)		11

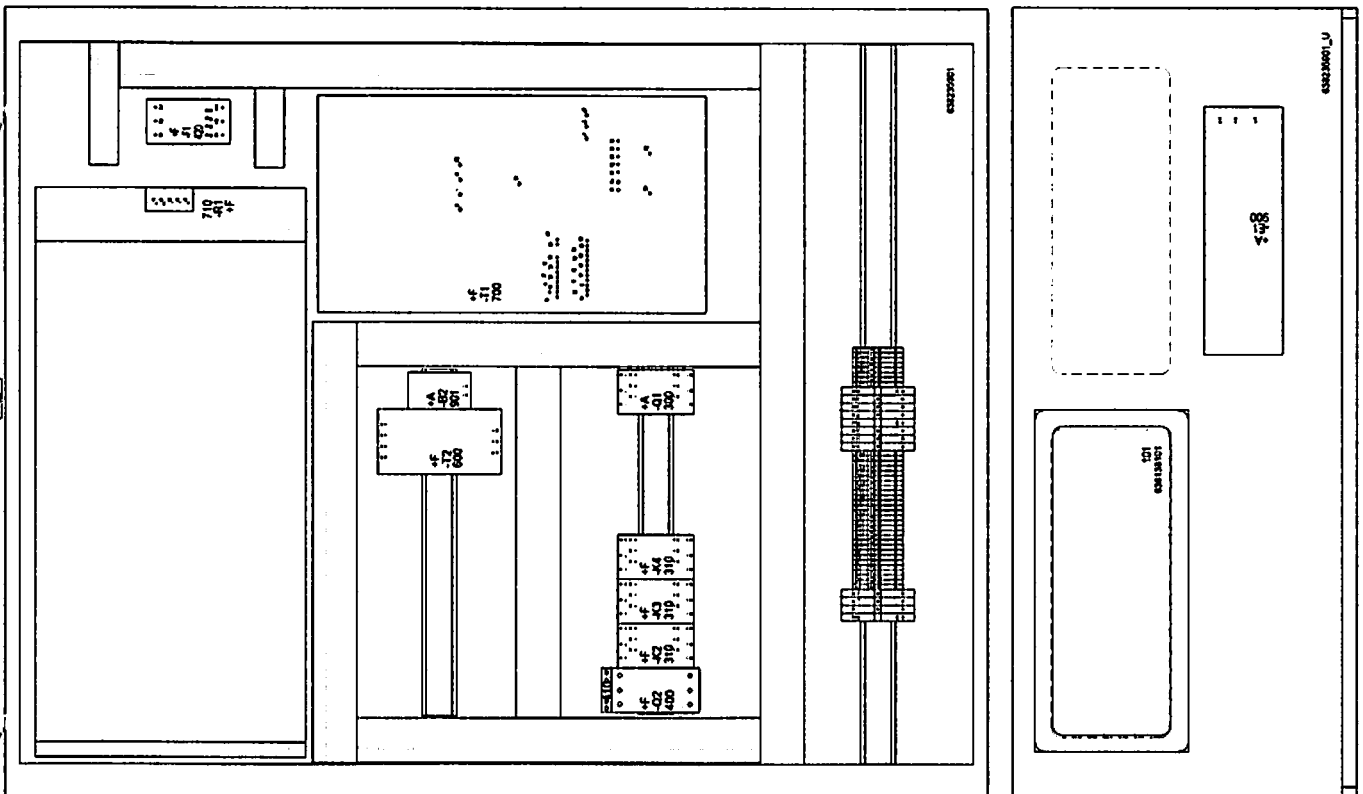

Pos. 902
Austrittfilter
in Tür
montieren

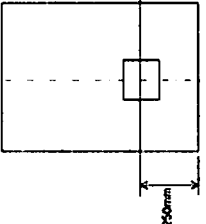

171	+	PE	+	171
170	○	35	○	170
170	○	34	○	170
170	○	33	○	170
171	+	PE	+	171
170	○	32	○	170
170	○	31	○	170
170	○	30	○	170
175	○	PE	○	175
174	○	27	○	174
174	○	26	○	174
175	○	PE	○	175
174	○	25	○	174
174	○	24	○	174
175	○	PE	○	175
174	○	20	○	174
174	○	19	○	174
175	○	PE	○	175
174	○	18	○	174
174	○	17	○	174
175	○	PE	○	175
174	○	16	○	174
174	○	15	○	174
174	○	14	○	174
174	○	13	○	174
174	○	12	○	174
174	○	11	○	174
174	○	10	○	174
174	○	9	○	174
174	○	8	○	174
174	○	7	○	174
174	○	6	○	174
174	○	5	○	174
174	○	5	○	174
174	○	4	○	174
174	○	4	○	174
170	○	3	○	170
170	○	2	○	170
170	○	1	○	170
171	+	PE	+	171
174	○	50	○	174
174	○	51	○	174
174	○	52	○	174
175	○	PE	○	175
174	○	130	○	174
174	○	131	○	174
174	○	132	○	174
174	○	133	○	174