

3	Gez.	24.08.09	KUGLER	LIEBHERR-WERK	11-EINSPESUNG	TYPE	EC-H/EC-B FRctronic	Blatt	3+
2	Bearb.	JUNI 04	KUGLER	BIDERACH GMBH	SUPPLY	Zeichn-Nr.	4005-22005	Blatt	3+
1	Änderung	11.12.05	KUGLER	Copyright (c)	ALIMENTATION	Ident. Nr.	933531001		

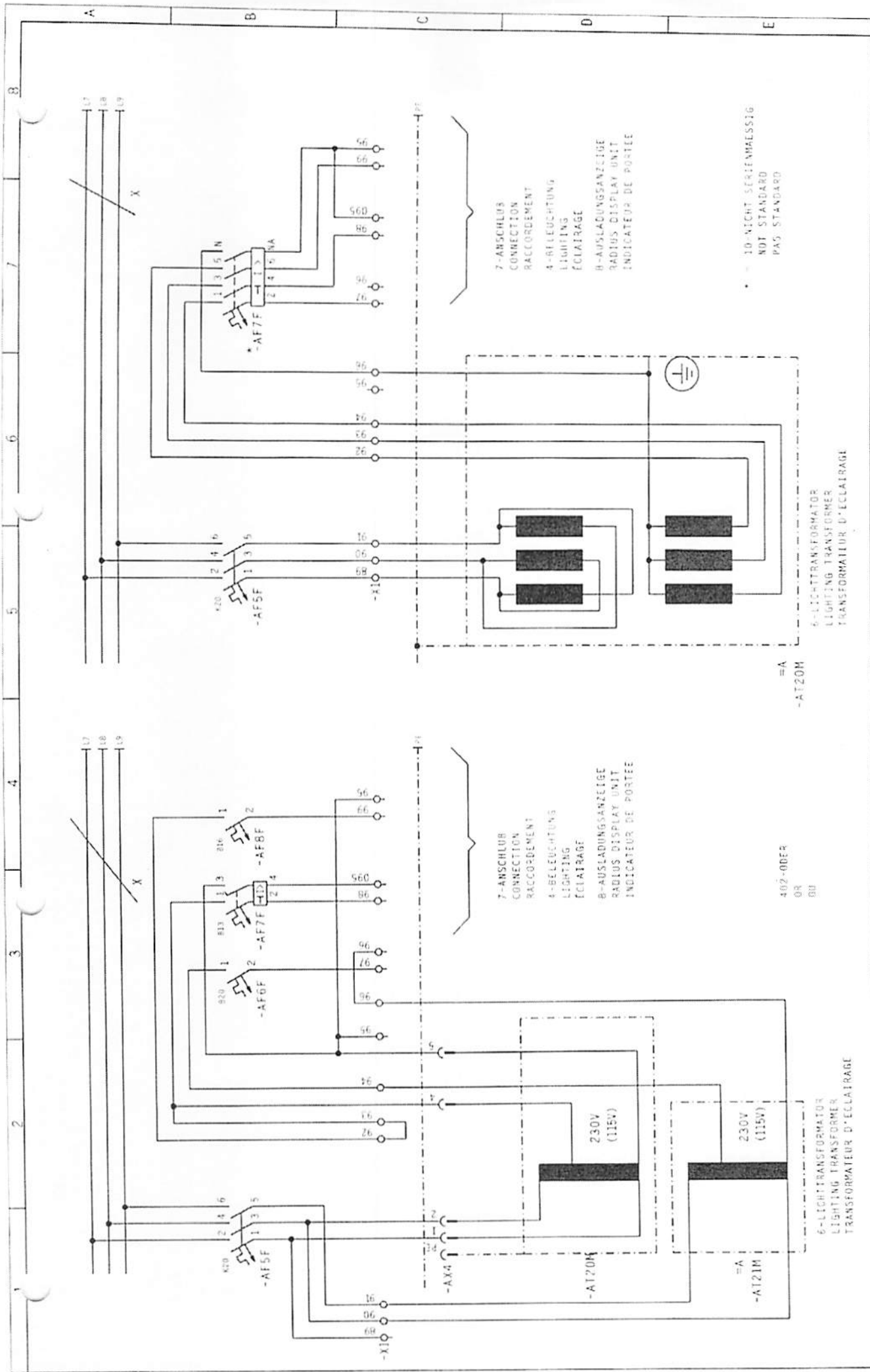

3	Gez.	24.08.09	KUGLER	MASSZAB	LIEBHERR-WERK	TYPE	EC-H/EC-B FRTronic	Bl.	01
2	Bearb.	JUNI 04	KUGLER		BIBERACH GMBH	Zeich.Nr.	4005-22005	Blatt	4
1	Proj.					Best.Nr.	933531001		

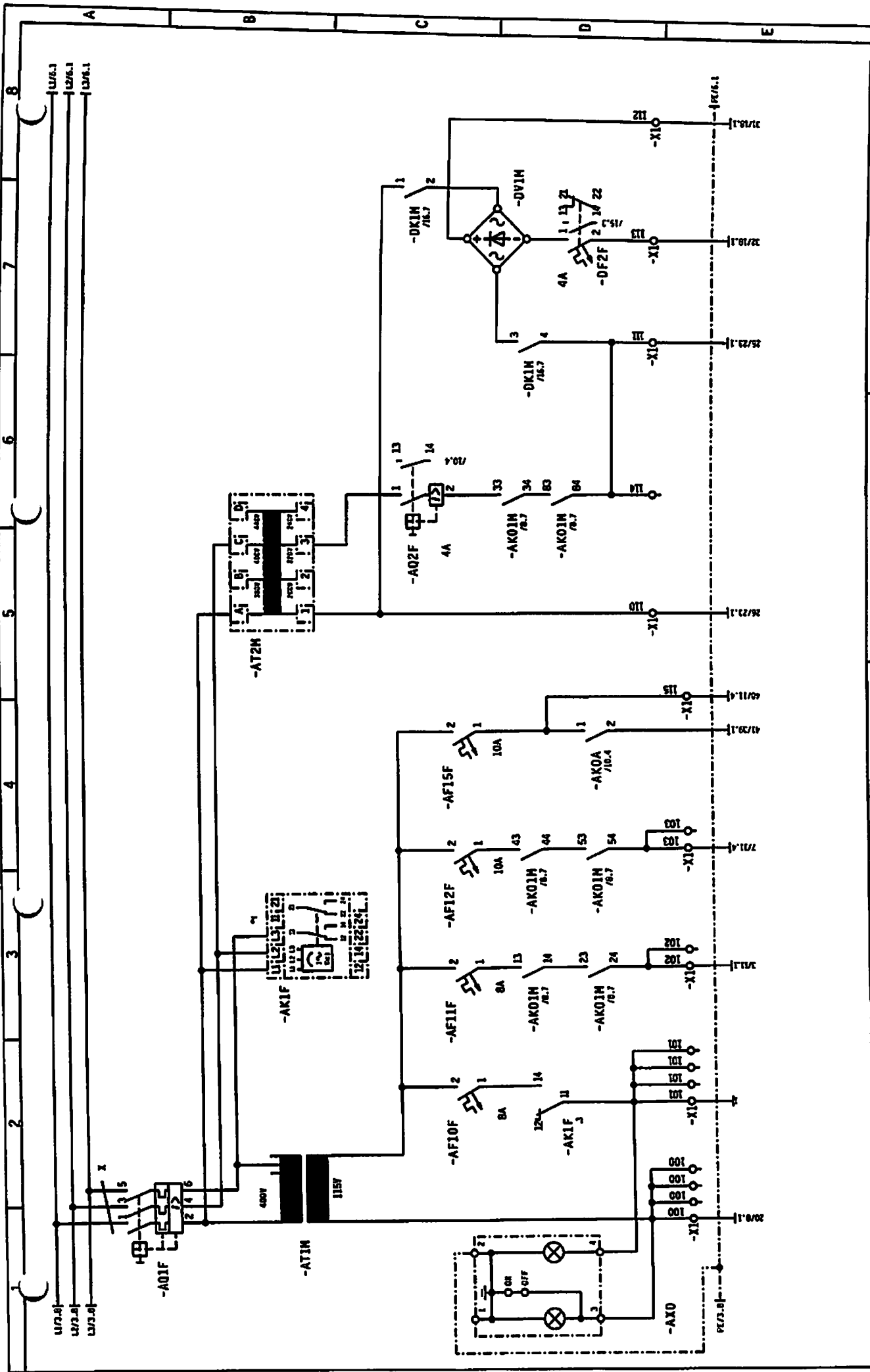

3	Rev.	24.08.09	KUGLER	Maßstab	1:1	TYPE	EC-N/EC-B Frötronic	n	SI
2	Gepr.	JUNI 04	KUGLER			Zusatz-Nr.	4005-22005	+	0101
1									5+
									933531001

152-STEuerungsspannung  
 CONTROL VOLTAGE  
 TENSION DE COMMANDE

LIEBHERR-WERK  
 BIBERACH GmbH  
 Copyright © 2009

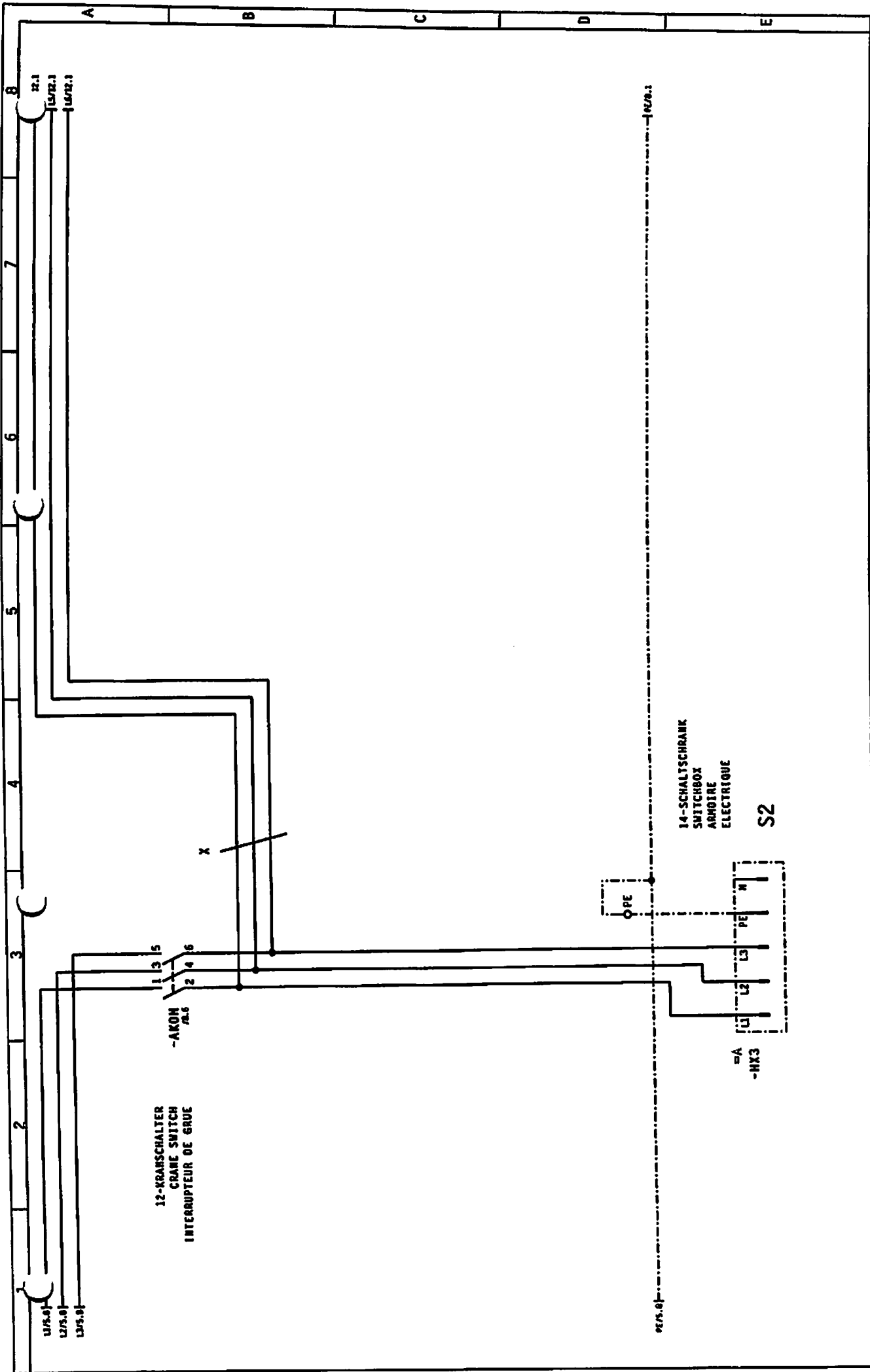

3																SI		
2																6+		
1																Edict Nr. 93353/001		
11-EINSPEISUNG SUPPLY ALIMENTATION													TYPE EC-H/EC-B FRTronic Zulch-Ref. 4005-22005					
LIEBHERR-WERK BIBERACH GmbH <i>Copyright 1971</i>										Modultab :								
Ser. 24.08.09 Beerb. JUNI 04			KUGLER KUGLER			KUGLER KUGLER			Modultab :									
Datum :			Datum :			Datum :			Datum :									
Andrerung :																		

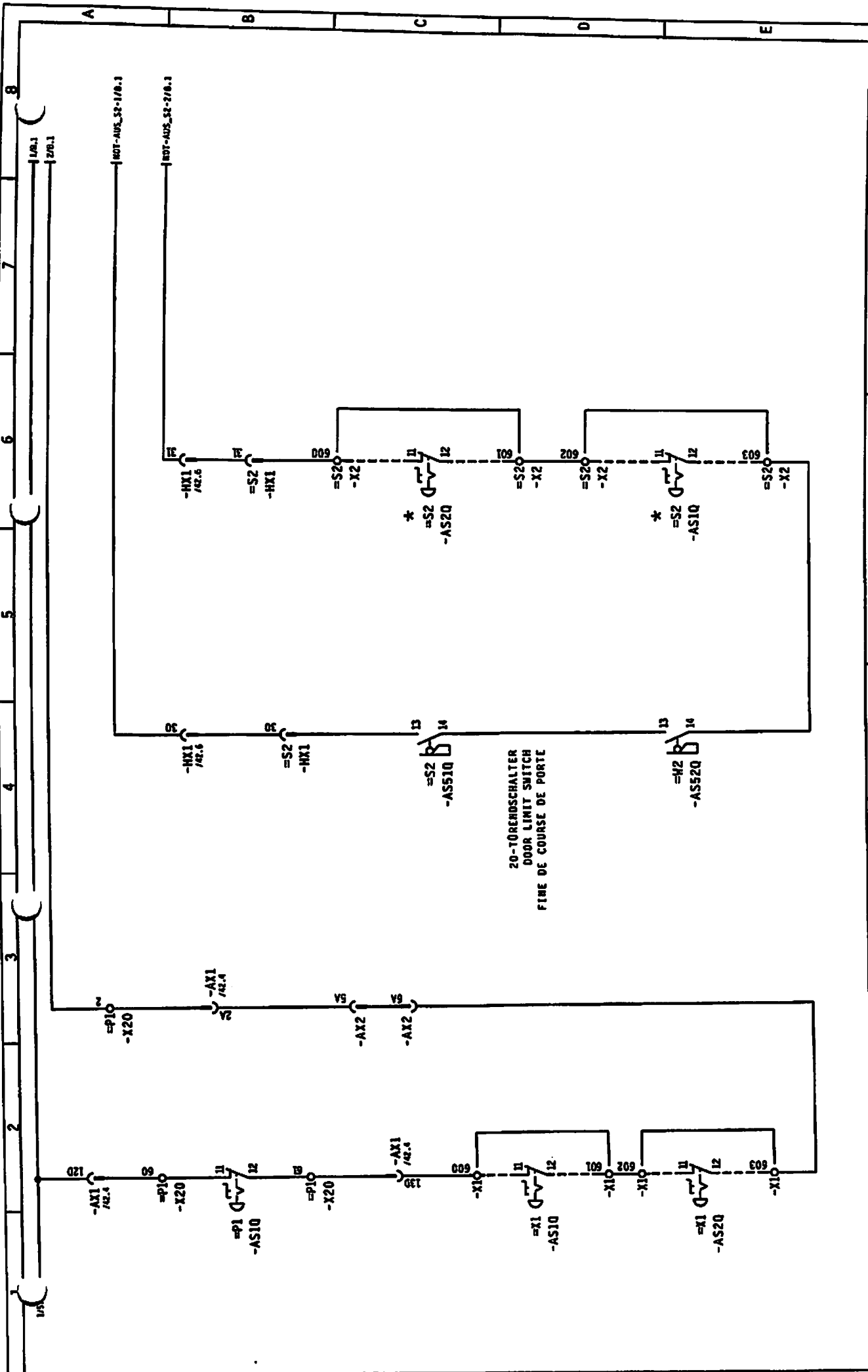

3		Gez.	24.08.09	KUGLER	Modul	16-STEUERUNG CONTROL SYSTEM SYSTEME DE COMMANDE		TYPE	EC-H/EC-B Frtronic	SI
2		Bearb.	JUNI 04	KUGLER	:	LIEBHERR-WERK BIBERACH GMBH		Zuteil-nr.	4005-22005	7+
1		Datum		Bece		Copyright (c)				Libert Nr. 933531001

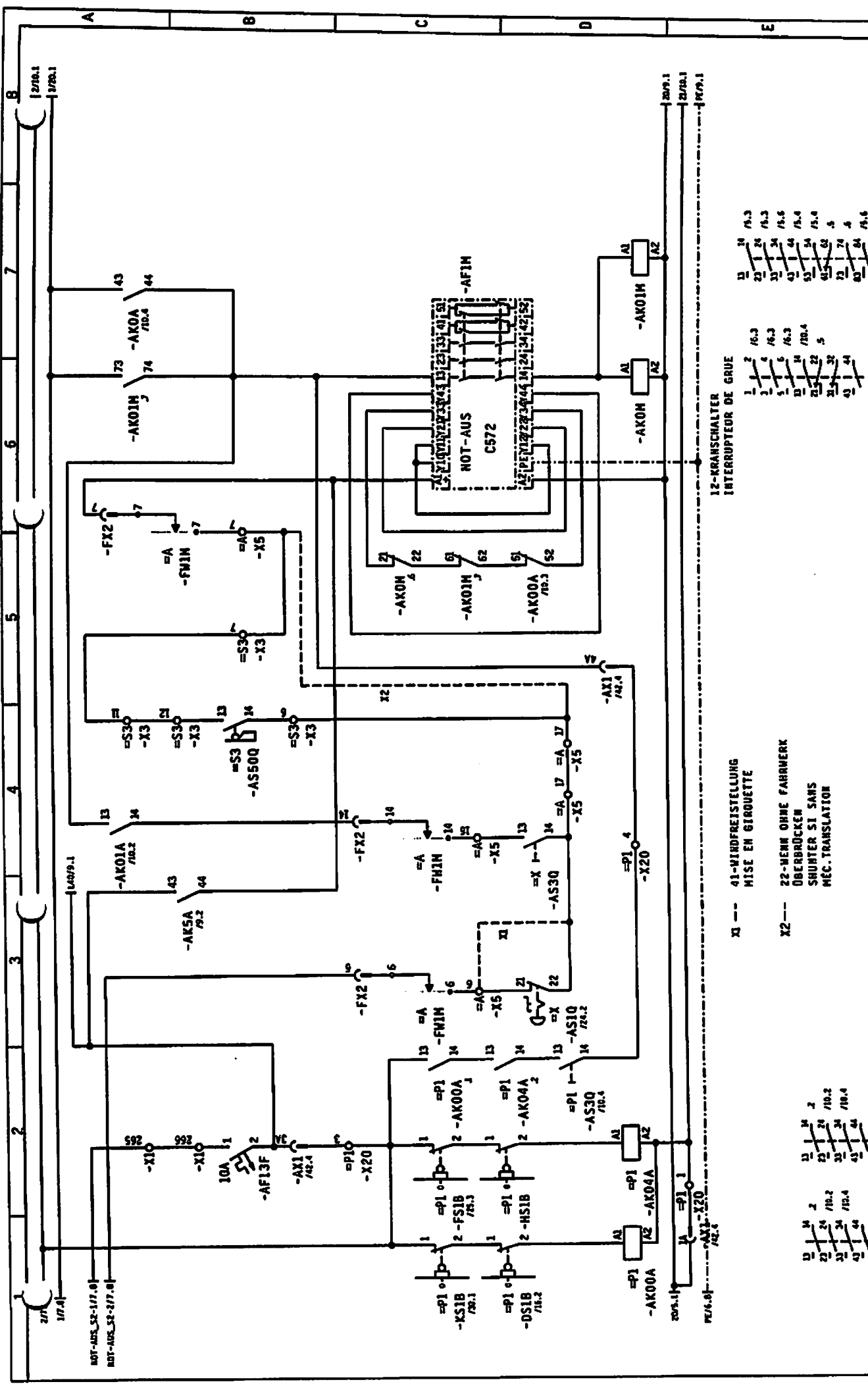

XI --- 41-NINDFREITSTELLUNG  
 MISE EN GIERQUETTE  
  
 X2 --- 22-NENN OHNE FAHRWERK  
 ÜBERBRÜCKEN  
 SHUNTER SI SANS  
 MEC. TRANSLATION

12	13	14	15	16	17	18	19	20	21	22
12	13	14	15	16	17	18	19	20	21	22
12	13	14	15	16	17	18	19	20	21	22
12	13	14	15	16	17	18	19	20	21	22

1	2	3	4	5	6	7	8	9	10	11	12	13	14	15	16
1	2	3	4	5	6	7	8	9	10	11	12	13	14	15	16
1	2	3	4	5	6	7	8	9	10	11	12	13	14	15	16
1	2	3	4	5	6	7	8	9	10	11	12	13	14	15	16

3	24.08.09	KUGLER	Mitstap	LIEBHERR-WERK	TYPE	EC-H/EC-B	FRCFRONIC	SI
2	JUNI 04	KUGLER	:	BIBERACH GmbH	Zeich-nr.	4005-22005		B+
1								Leitf. Nr. 933531001
Anforderung		Belieb	WUOP	Gr.	Sam.	Belieb	WUOP	

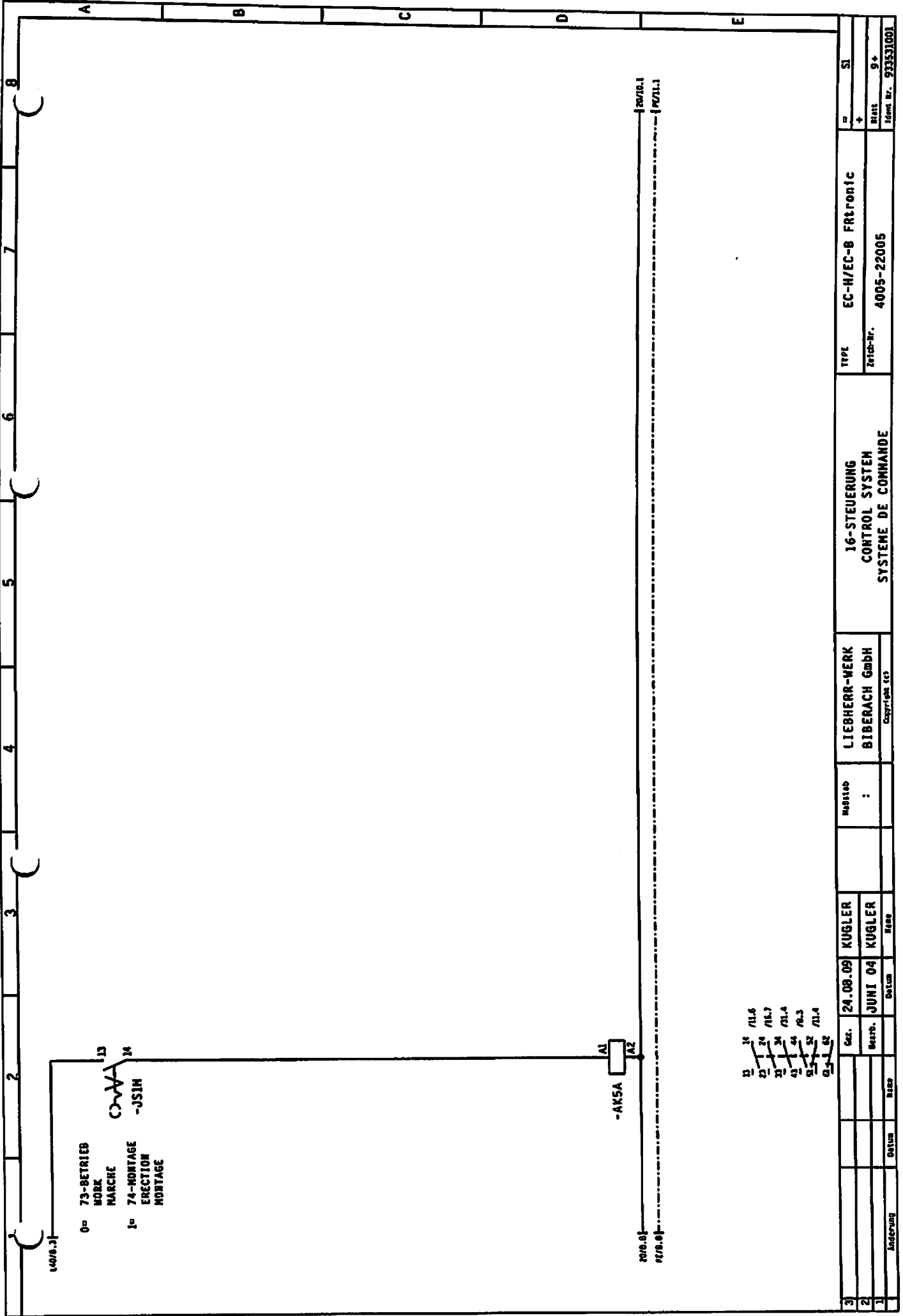

- 11 18 /11.6
- 22 1 24 /16.7
- 32 1 24 /11.4
- 42 1 24 /16.3
- 52 1 24 /11.4
- 63-1 28









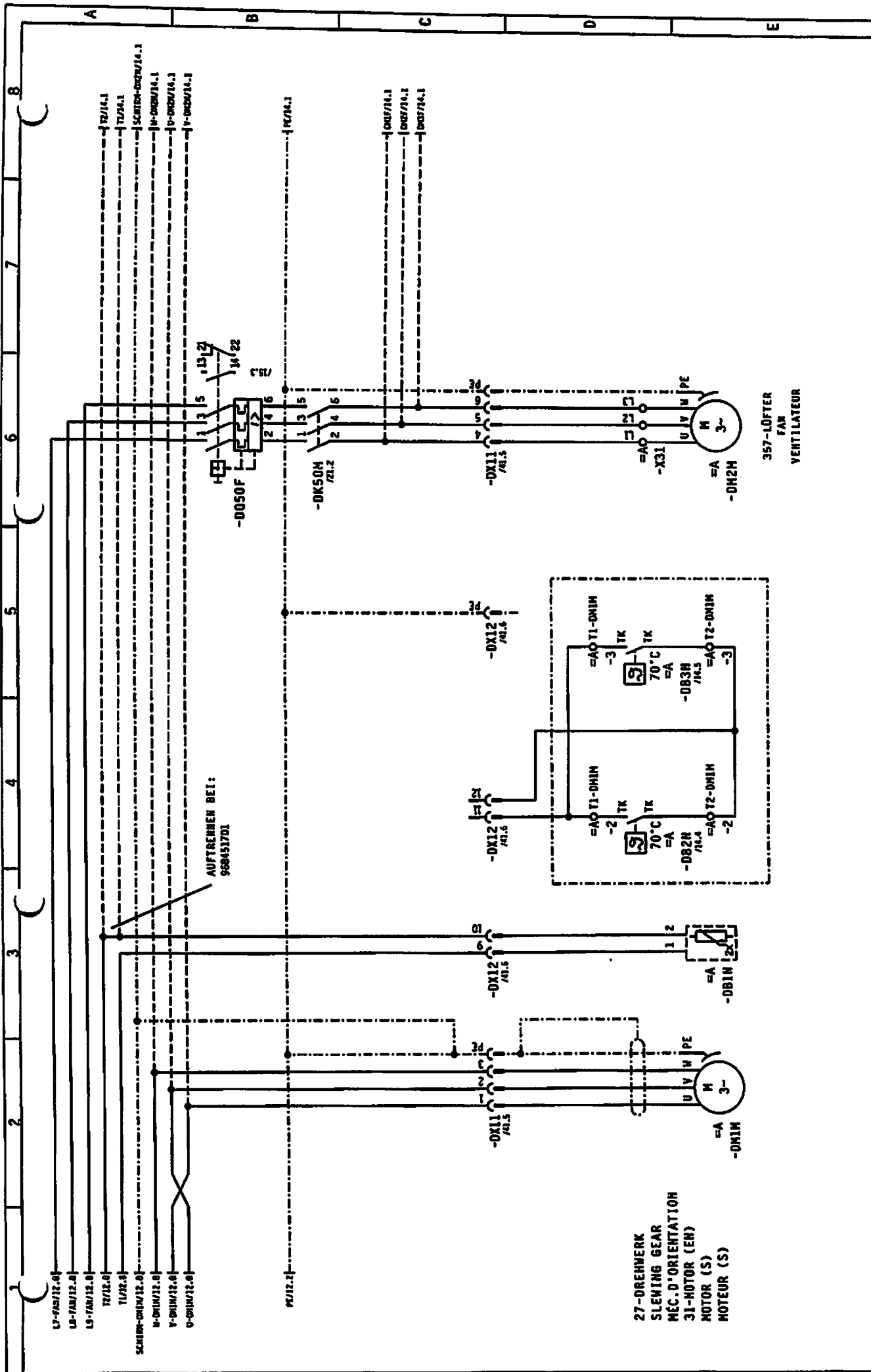

12-FAH/12.0] 12/14.1  
 13-FAH/12.0] 12/14.1  
 14-FAH/12.0] 12/14.1  
 15-FAH/12.0] 12/14.1  
 16-FAH/12.0] 12/14.1  
 17-FAH/12.0] 12/14.1  
 18-FAH/12.0] 12/14.1  
 19-FAH/12.0] 12/14.1  
 20-FAH/12.0] 12/14.1  
 21-FAH/12.0] 12/14.1  
 22-FAH/12.0] 12/14.1  
 23-FAH/12.0] 12/14.1  
 24-FAH/12.0] 12/14.1  
 25-FAH/12.0] 12/14.1  
 26-FAH/12.0] 12/14.1  
 27-FAH/12.0] 12/14.1  
 28-FAH/12.0] 12/14.1  
 29-FAH/12.0] 12/14.1  
 30-FAH/12.0] 12/14.1  
 31-FAH/12.0] 12/14.1  
 32-FAH/12.0] 12/14.1  
 33-FAH/12.0] 12/14.1  
 34-FAH/12.0] 12/14.1  
 35-FAH/12.0] 12/14.1  
 36-FAH/12.0] 12/14.1  
 37-FAH/12.0] 12/14.1  
 38-FAH/12.0] 12/14.1  
 39-FAH/12.0] 12/14.1  
 40-FAH/12.0] 12/14.1  
 41-FAH/12.0] 12/14.1  
 42-FAH/12.0] 12/14.1  
 43-FAH/12.0] 12/14.1  
 44-FAH/12.0] 12/14.1  
 45-FAH/12.0] 12/14.1  
 46-FAH/12.0] 12/14.1  
 47-FAH/12.0] 12/14.1  
 48-FAH/12.0] 12/14.1  
 49-FAH/12.0] 12/14.1  
 50-FAH/12.0] 12/14.1  
 51-FAH/12.0] 12/14.1  
 52-FAH/12.0] 12/14.1  
 53-FAH/12.0] 12/14.1  
 54-FAH/12.0] 12/14.1  
 55-FAH/12.0] 12/14.1  
 56-FAH/12.0] 12/14.1  
 57-FAH/12.0] 12/14.1  
 58-FAH/12.0] 12/14.1  
 59-FAH/12.0] 12/14.1  
 60-FAH/12.0] 12/14.1  
 61-FAH/12.0] 12/14.1  
 62-FAH/12.0] 12/14.1  
 63-FAH/12.0] 12/14.1  
 64-FAH/12.0] 12/14.1  
 65-FAH/12.0] 12/14.1  
 66-FAH/12.0] 12/14.1  
 67-FAH/12.0] 12/14.1  
 68-FAH/12.0] 12/14.1  
 69-FAH/12.0] 12/14.1  
 70-FAH/12.0] 12/14.1  
 71-FAH/12.0] 12/14.1  
 72-FAH/12.0] 12/14.1  
 73-FAH/12.0] 12/14.1  
 74-FAH/12.0] 12/14.1  
 75-FAH/12.0] 12/14.1  
 76-FAH/12.0] 12/14.1  
 77-FAH/12.0] 12/14.1  
 78-FAH/12.0] 12/14.1  
 79-FAH/12.0] 12/14.1  
 80-FAH/12.0] 12/14.1  
 81-FAH/12.0] 12/14.1  
 82-FAH/12.0] 12/14.1  
 83-FAH/12.0] 12/14.1  
 84-FAH/12.0] 12/14.1  
 85-FAH/12.0] 12/14.1  
 86-FAH/12.0] 12/14.1  
 87-FAH/12.0] 12/14.1  
 88-FAH/12.0] 12/14.1  
 89-FAH/12.0] 12/14.1  
 90-FAH/12.0] 12/14.1  
 91-FAH/12.0] 12/14.1  
 92-FAH/12.0] 12/14.1  
 93-FAH/12.0] 12/14.1  
 94-FAH/12.0] 12/14.1  
 95-FAH/12.0] 12/14.1  
 96-FAH/12.0] 12/14.1  
 97-FAH/12.0] 12/14.1  
 98-FAH/12.0] 12/14.1  
 99-FAH/12.0] 12/14.1  
 100-FAH/12.0] 12/14.1

27-DREHWERK  
 SLEWING GEAR  
 MEC. D'ORIENTATION  
 31-MOTOR (EH)  
 MOTOR (S)  
 MOTEUR (S)

357-LÖFTER  
 FAN  
 VENTILATEUR

AUFZEHREN BEI:  
 968451701

3	Gez.	24.08.09	KUGLER	LIEBHERR-WERK	27-DREHWERK	TYPE	EC-H/EC-B FRECONIC	SI
2	Bearb.	DEZ 04	KUGLER	BIBERACH GmbH	SLEWING GEAR	Best-Nr.	4005-22005	Breit
1	Beleg			Copyright (C)	MEC. D'ORIENTATION	Best-Nr.	933531001	B+

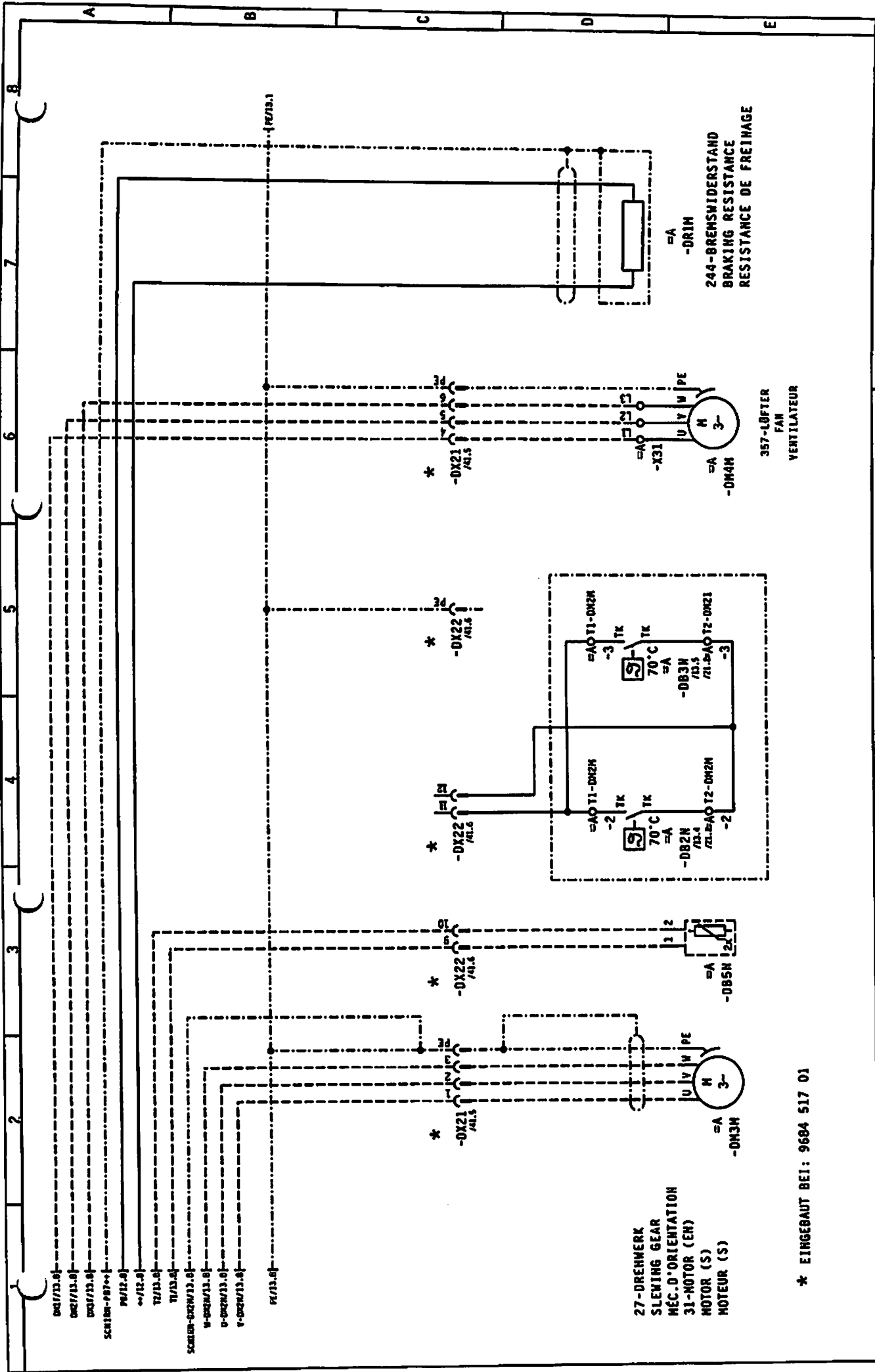

\* EINGEBAUT BEI: 9684 517 01

3	Gez.	24.08.09	KUGLER	LIEBHERR-WERK	27-DREHWERK	TYPE	EC-H/EC-B FRCONIC	№	SI
2	Bearb.	DEZ 04	KUGLER	BIBERACH GmbH	SLEWING GEAR	Zeich.-Nr.	4005-22005	Blatt	34+
1	Änderung			Copyright (c)	MEC. D'ORIENTATION			Blatt Nr.	933531001



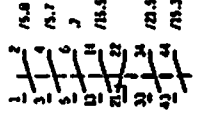
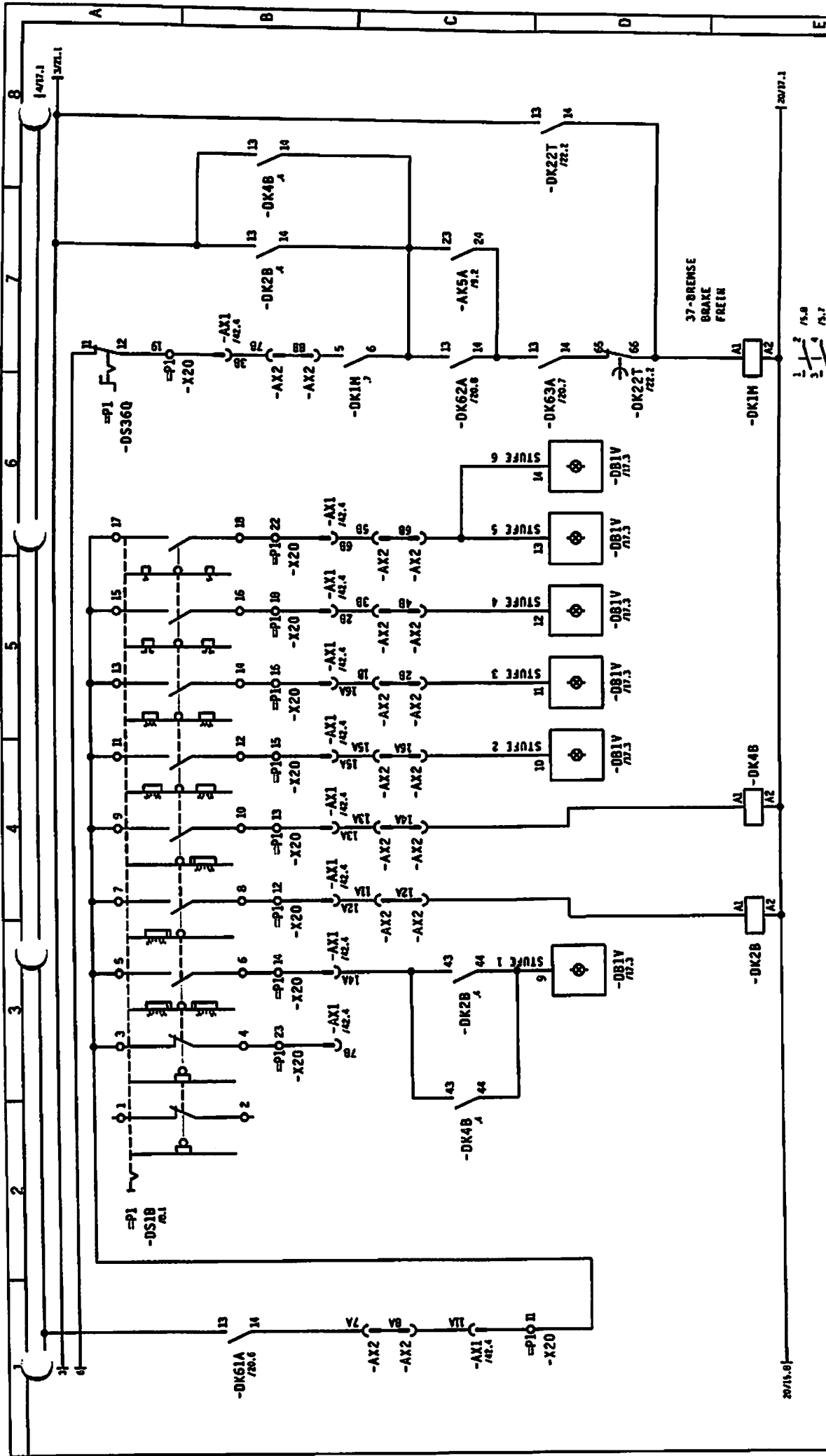

3																						TYPE	EC-N/EC-B FrTronic		SI				
2	2003164	Zf.03.06	KUGLER	JUNI 04	KUGLER																	Zusatz-Nr.	4005-22005	Stück	15+				
1																								IG-Nr.	933531001				
Anspruch			Datei			Name			MkStab			LIEBHERR-WERK BIEBRACH GMBH			27-DREHWERK SLEWING GEAR MEC.D'ORIENTATION			EC-N/EC-B FrTronic			Zusatz-Nr.			4005-22005		Stück		15+	
			24.08.09			KUGLER			: :			LIEBHERR-WERK BIEBRACH GMBH			27-DREHWERK SLEWING GEAR MEC.D'ORIENTATION			EC-N/EC-B FrTronic			Zusatz-Nr.			4005-22005		Stück		15+	
												LIEBHERR-WERK BIEBRACH GMBH			27-DREHWERK SLEWING GEAR MEC.D'ORIENTATION			EC-N/EC-B FrTronic			Zusatz-Nr.			4005-22005		Stück		15+	



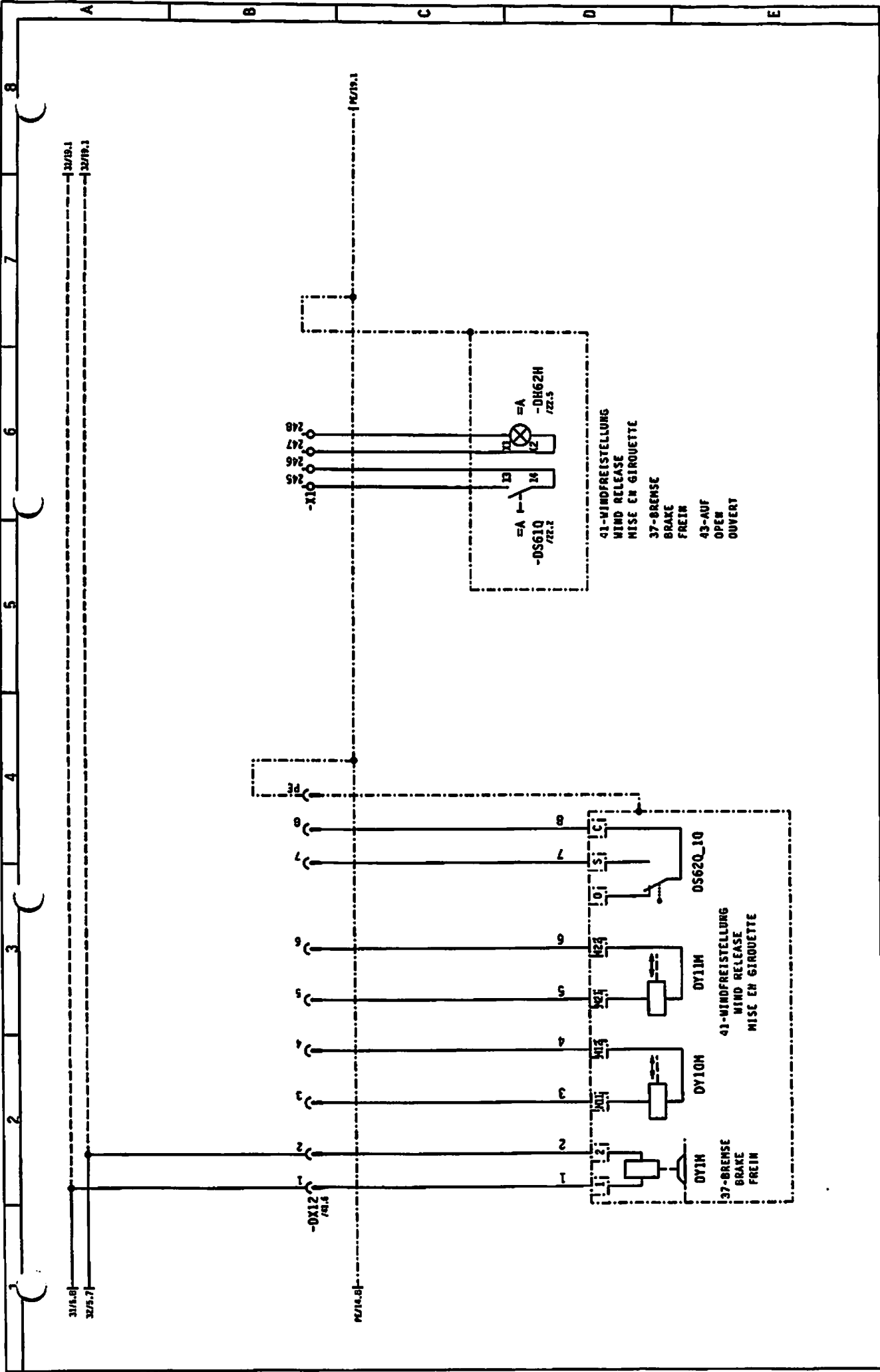

3	Gez.	24.08.09	KUGLER	Revizor		LIEBHERR-WERK BIBERACH GmbH	Typ	EC-H/EC-B Frtronic	SI
2	Gez.	JUNJ 04	KUGLER	Revizor		Copyright (C)	Zersch.Nr.	4005-22005	SI
1	Gez.			Revizor					SI
	Gez.			Revizor					SI
	Gez.			Revizor					SI



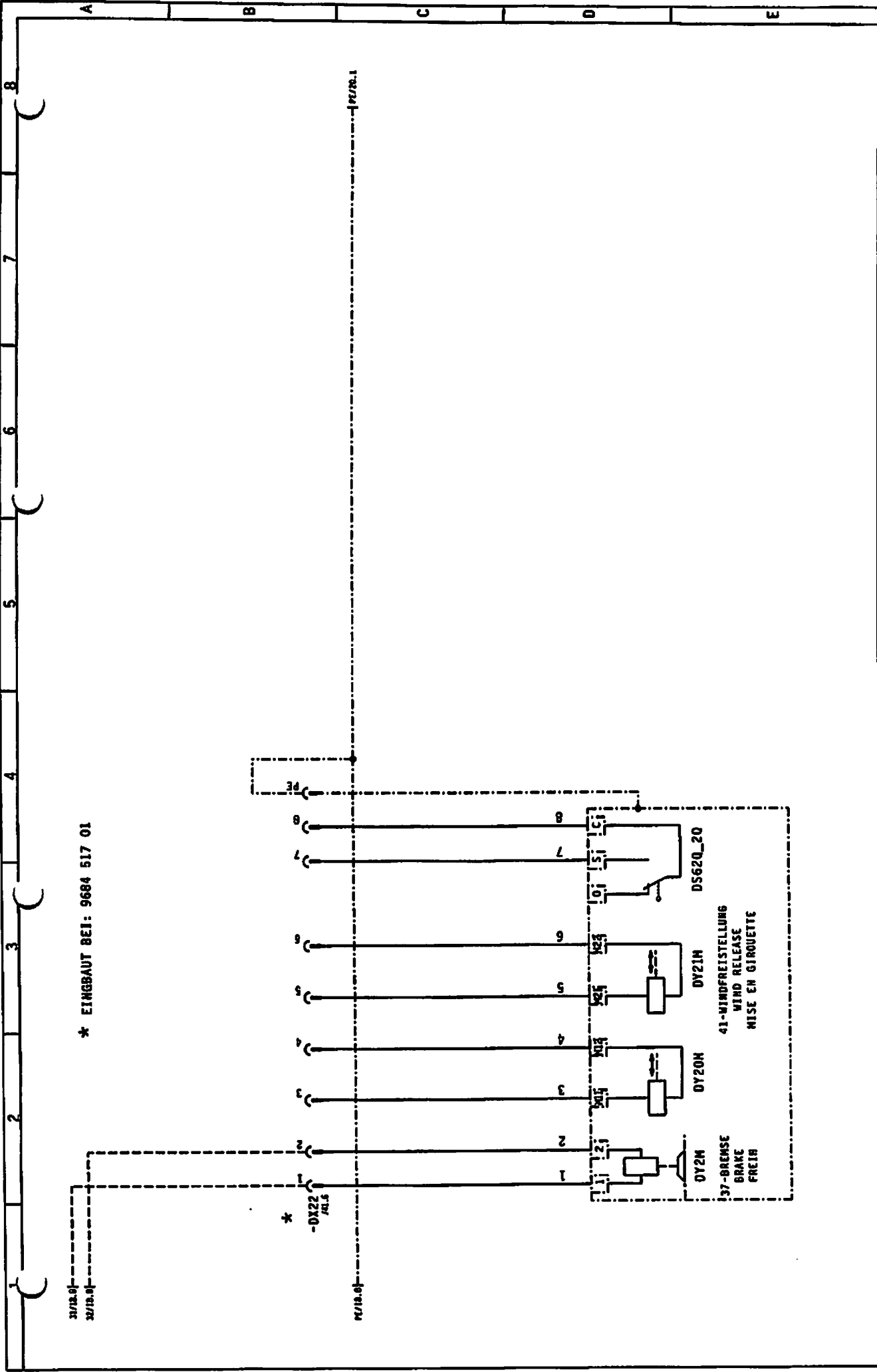

\* EINGBAUT BEI: 9684 517 01

17/18.01  
17/18.01

\*  
-DY22  
17/18.01

17/18.01

3		Gez.	24.08.09	e105		Masstab				Typ	EC-H/EC-B FRcronic	SI
2		Beurh.	JUNI 04	RUGLER		:				Zust-Nr.	4005-22005	19+
1		Beurh.										16-nr. 923531001
LIEBHERR-MERK BIBERACH GmbH Copyright (C)										27-DRENWERK SLEWING GEAR MCC.0'ORIENTATION		



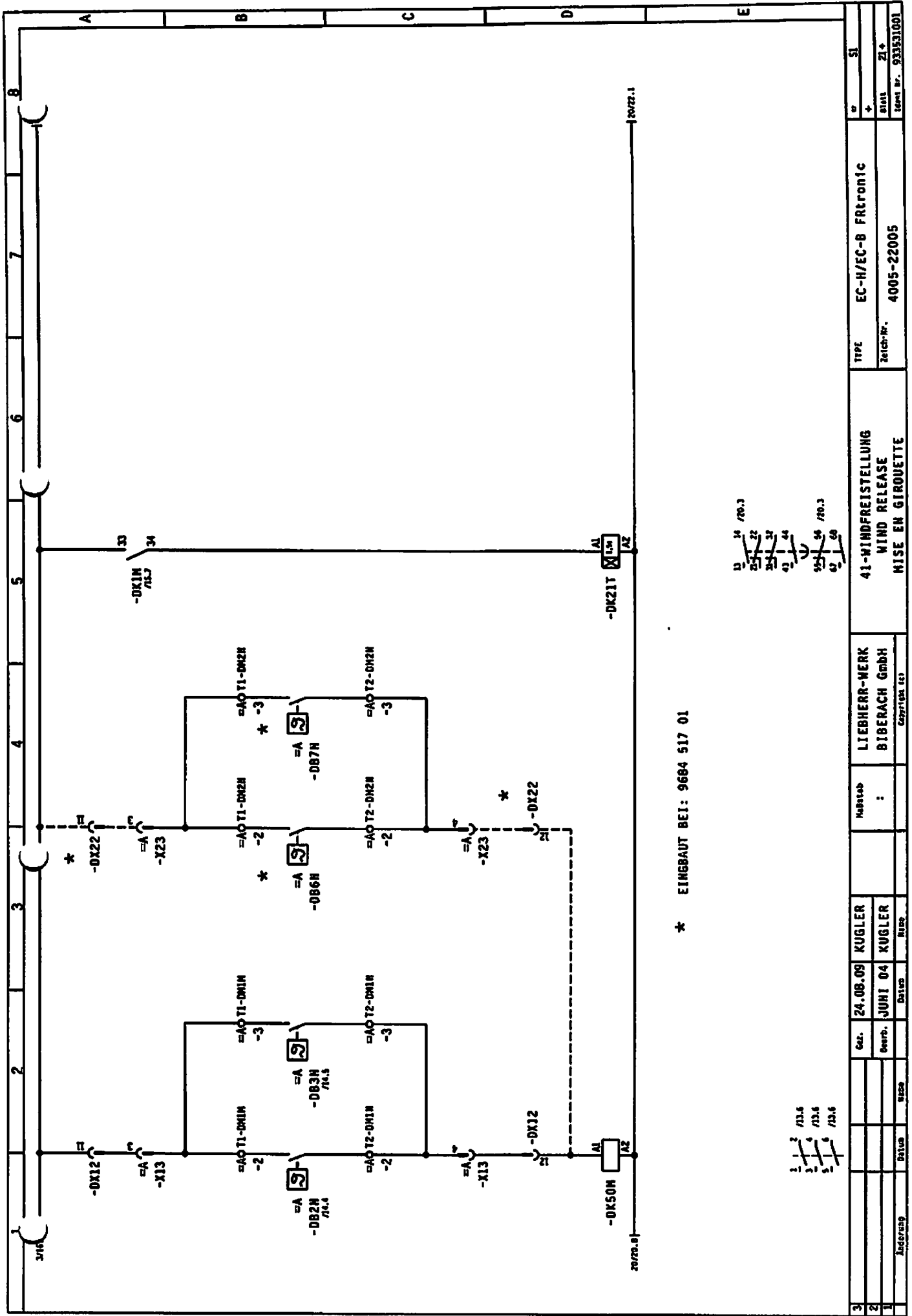

\* EINGBAUT BEI: 9684 517 01

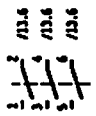
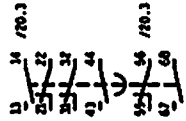

3		Ansprech	Datum	Satz	Rev.	24.08.09		KUGLER	LIEBHERR-WERK		41-WINDFREISTELLUNG WIND RELEASE MISE EN GIRQUETTE	TYPE	EC-H/EC-B FRTRONIC	nr	51		
2						JUNI 04		KUGLER	BIBERACH GmbH				Zeich-Nr.	4005-22005	+		
1									Copyright (c)						Blatt	Z1	
																Kenn-Nr.	933531001

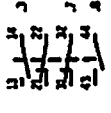
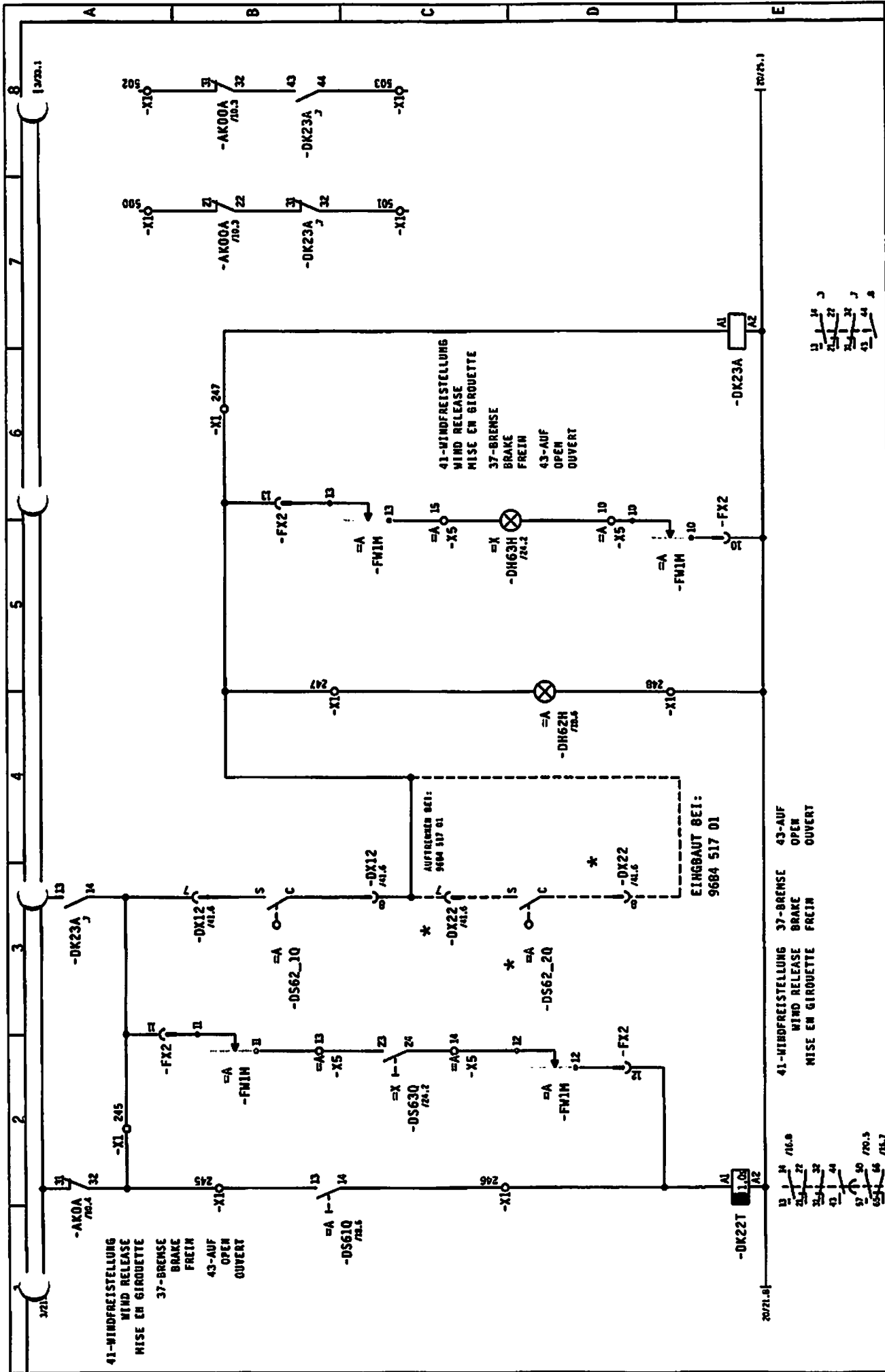

3	Ger.	24.08.09	KUGLER	Montab	LIEBHERR-WERK BIBERACH GmbH	41-WINDFREISTELLUNG WIND RELEASE MISE EN GIRQUETTE	TYPE EC-H/EC-B Frtronic	SI
2	Bearb.	JUNI 04	KUGLER				Zeich-nr.	22+
1	Adress						4005-22005	Ident. nr. 933531001



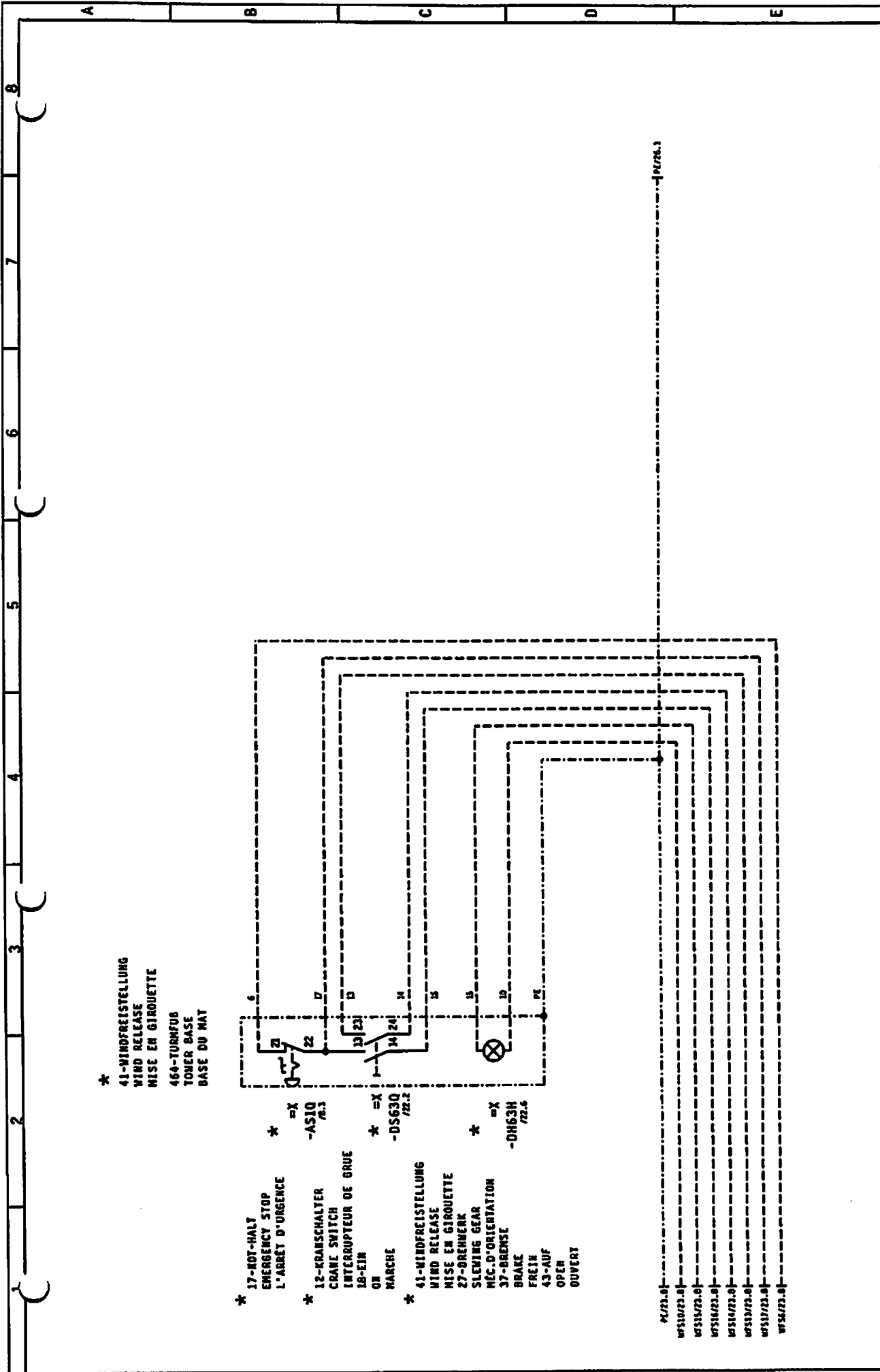

\*  
41-WINDFREISTELLUNG  
WIND RELEASE  
MISE EN GIRQUETTE  
464-TURNFUB  
TOWER BASE  
BASE DU MAT

- \* 17-NOT-HALT  
EMERGENCY STOP  
L'ARRET D'URGENCE
- \* 12-KRANSCHALTER  
CRANE SWITCH  
INTERRUPTEUR DE GRUE
- \* 41-WINDFREISTELLUNG  
WIND RELEASE  
MISE EN GIRQUETTE
- \* 27-DREHWERK  
SLEWING GEAR  
MÉC. D'ORIENTATION
- \* 37-BREMSE  
BRAKE  
FREIN
- \* 43-AUF  
OPER  
OUVERT
- \* =X -AS10 /22.3
- \* =X -DS63Q /22.2
- \* =X -0M63H /22.6

KABEL

3	Bez.	24.08.09	KUGLER	Mittelb	LIEBHERR-WERK BIBERACH GMBH	TYPE	EC-M/EC-B FRCronic	SI
2	Bevr.	JUNI 04	KUGLER	:		Art-Nr.	4005-22005	Blatt 24+
1	Adresse	Datum	Datum	Datum				Ident. Nr. 933531001

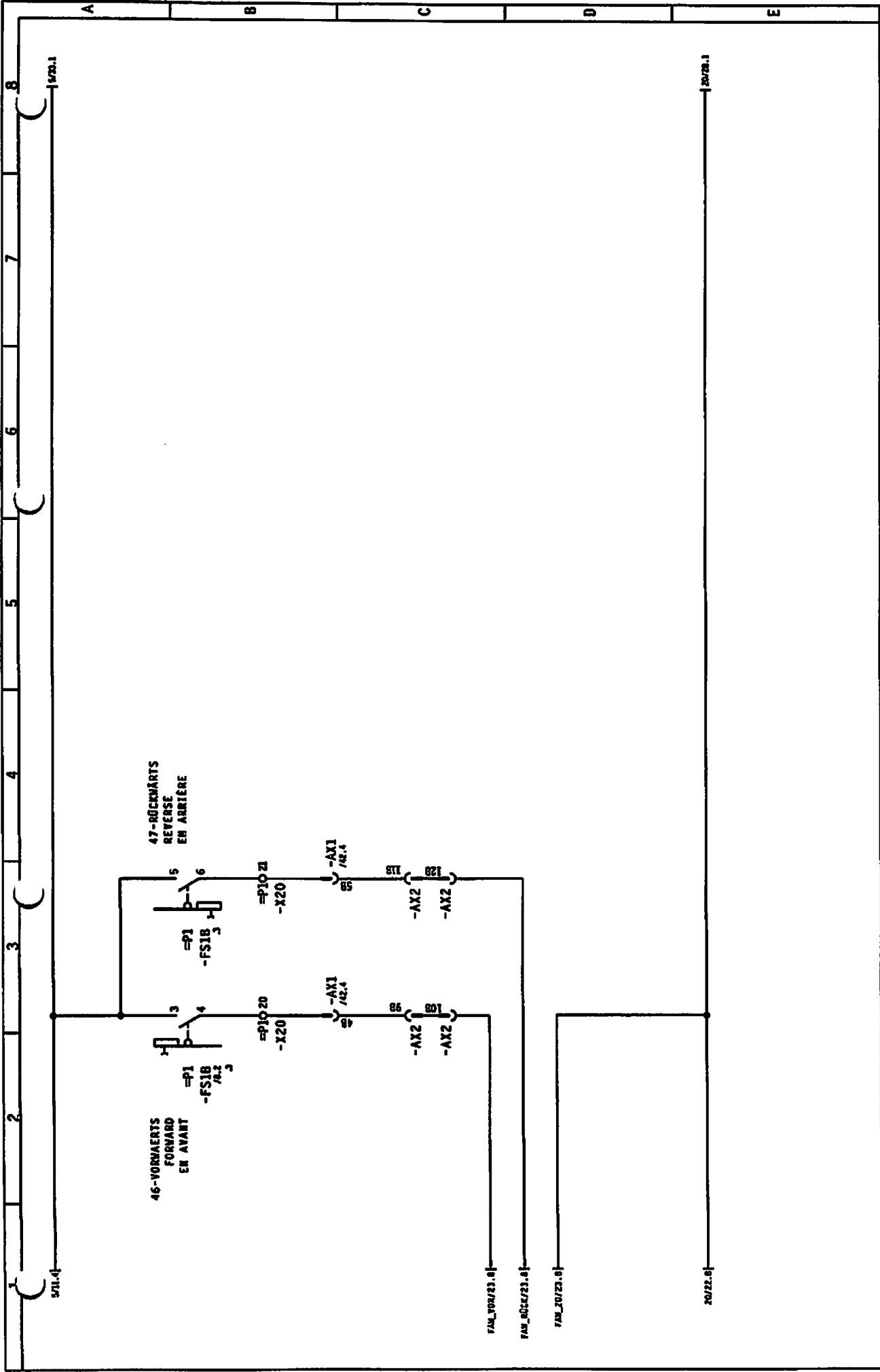

3	Anschrift												TYPE	EC-N/EC-B FRTRONIC		ST		
2	Manuf.												Zaich-Nr.	4005-22005		+		
1	Datum	JUNI 04	Datum													class	25+	
	Druck		Druck														Ident. Nr.	923531001
	Verf.	24.08.09	Verf.															
	Gepr.		Gepr.															

LIEBHERR-WERK  
BIBERACH GmbH  
Christlstr. 63

2B-FAHRWERK  
TRAVELLING GEAR  
L'ENSEMBLE DE TRANSLATION

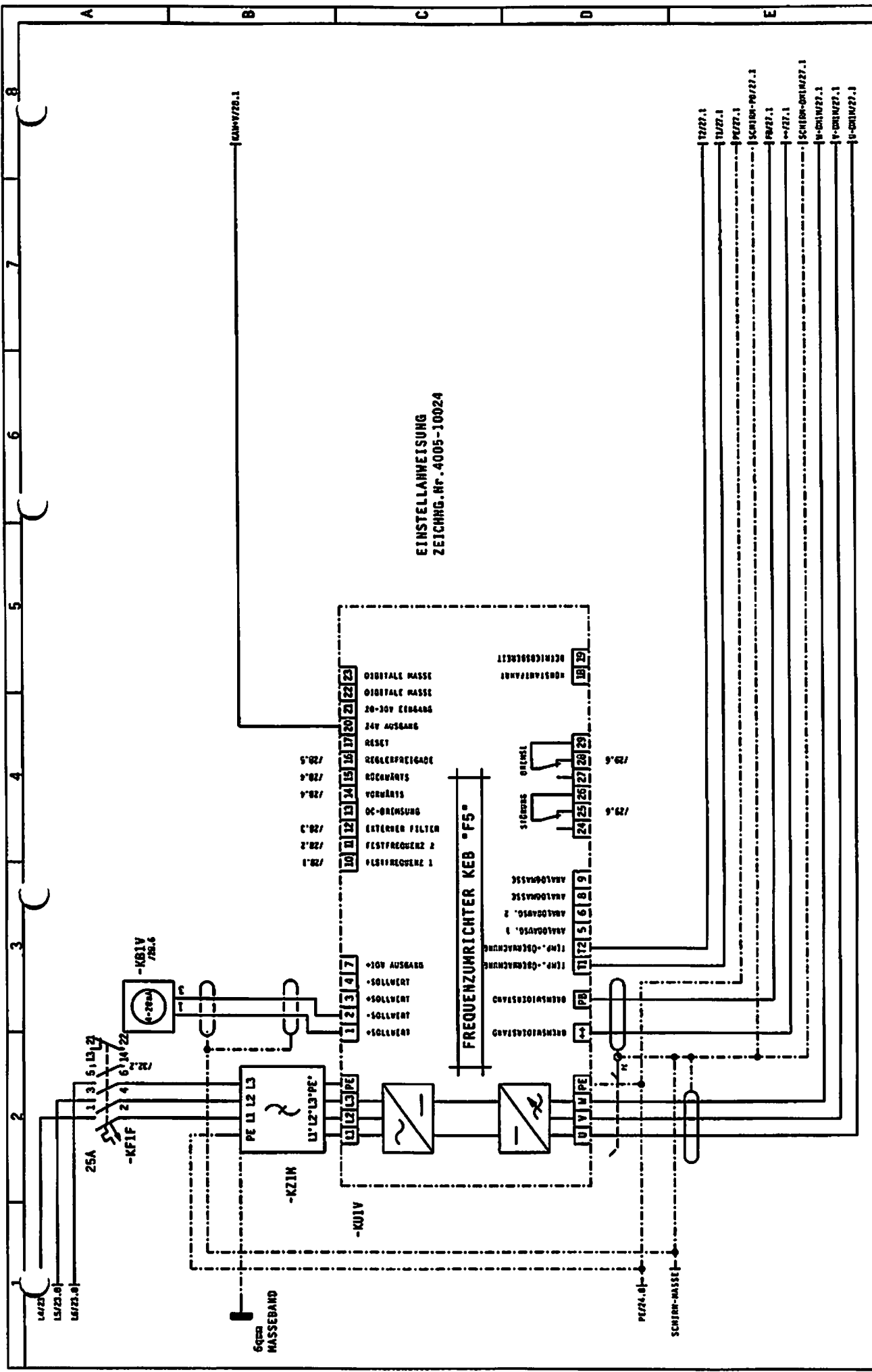

EINSTELLANWEISUNG  
ZEICHNG. NR. 4005-10024

3	Bez.	24.08.09	KUGLER	Projekt	LIEBHERR-WERK	TYPE	EC-H/EC-B FREPRONIC	SI
2	Bereit.	JUNI 04	KUGLER		BIBERACH GmbH	Zeich.-Nr.	4005-22005	26+
1	Adresse				HEC.DE DISTRIBUTION	Ident.-Nr.	933531001	



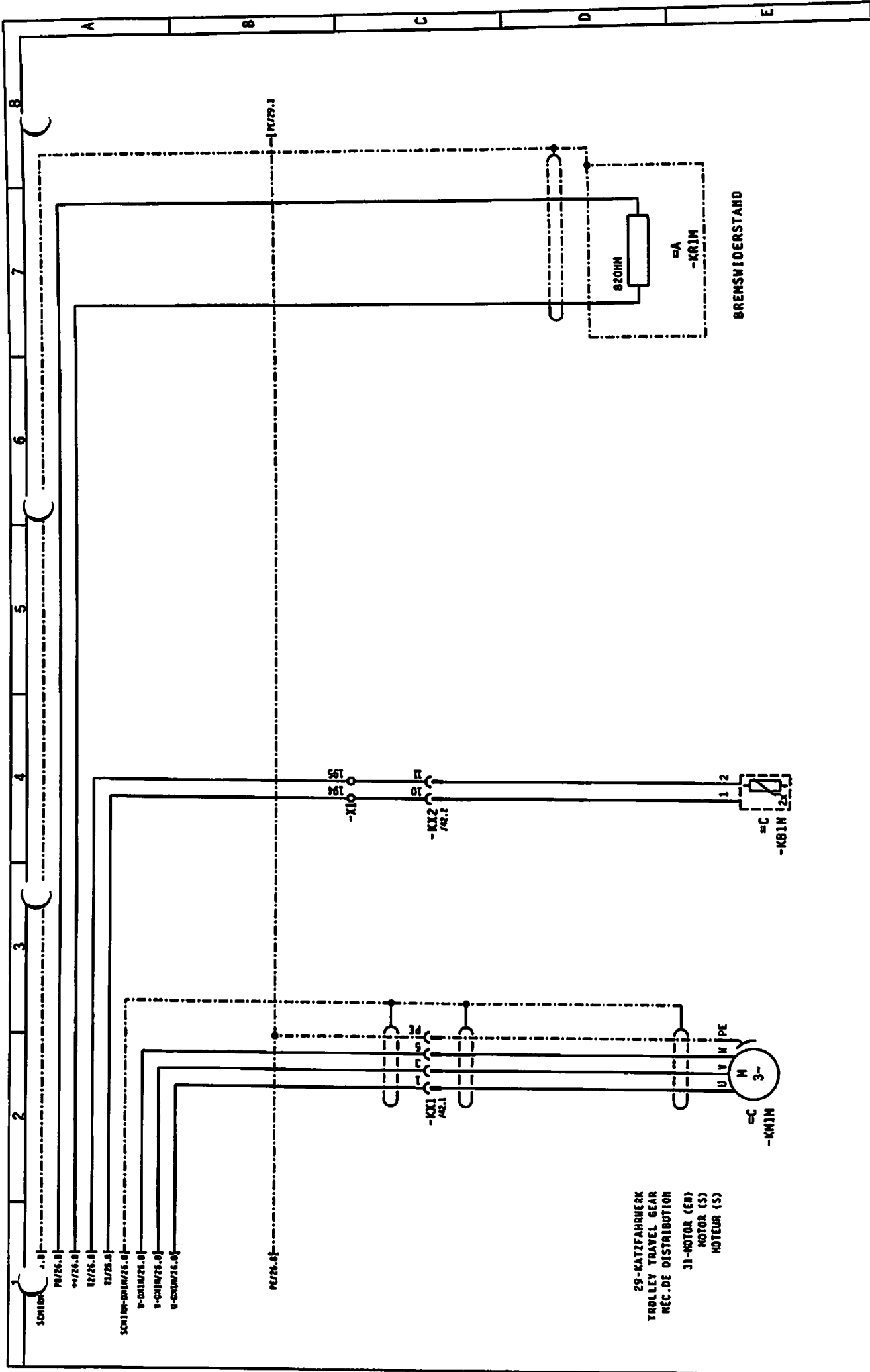

29-KATZFÄHRWERK  
 TROLLEY TRAVEL GEAR  
 MEC.DE DISTRIBUTION

31-MOTOR (EN)  
 MOTOR (S)  
 MOTEUR (S)

3												SI
2			24.08.09	KUGLER							TYPE	EC-H/EC-B PRtronic
1											Zeich.-Nr.	4005-22005
											29-KATZFÄHRWERK TROLLEY TRAVEL GEAR MEC.DE DISTRIBUTION	
											LIEBHERR-MERK BIBERACH GmbH	
										Gezeichnet (s)		

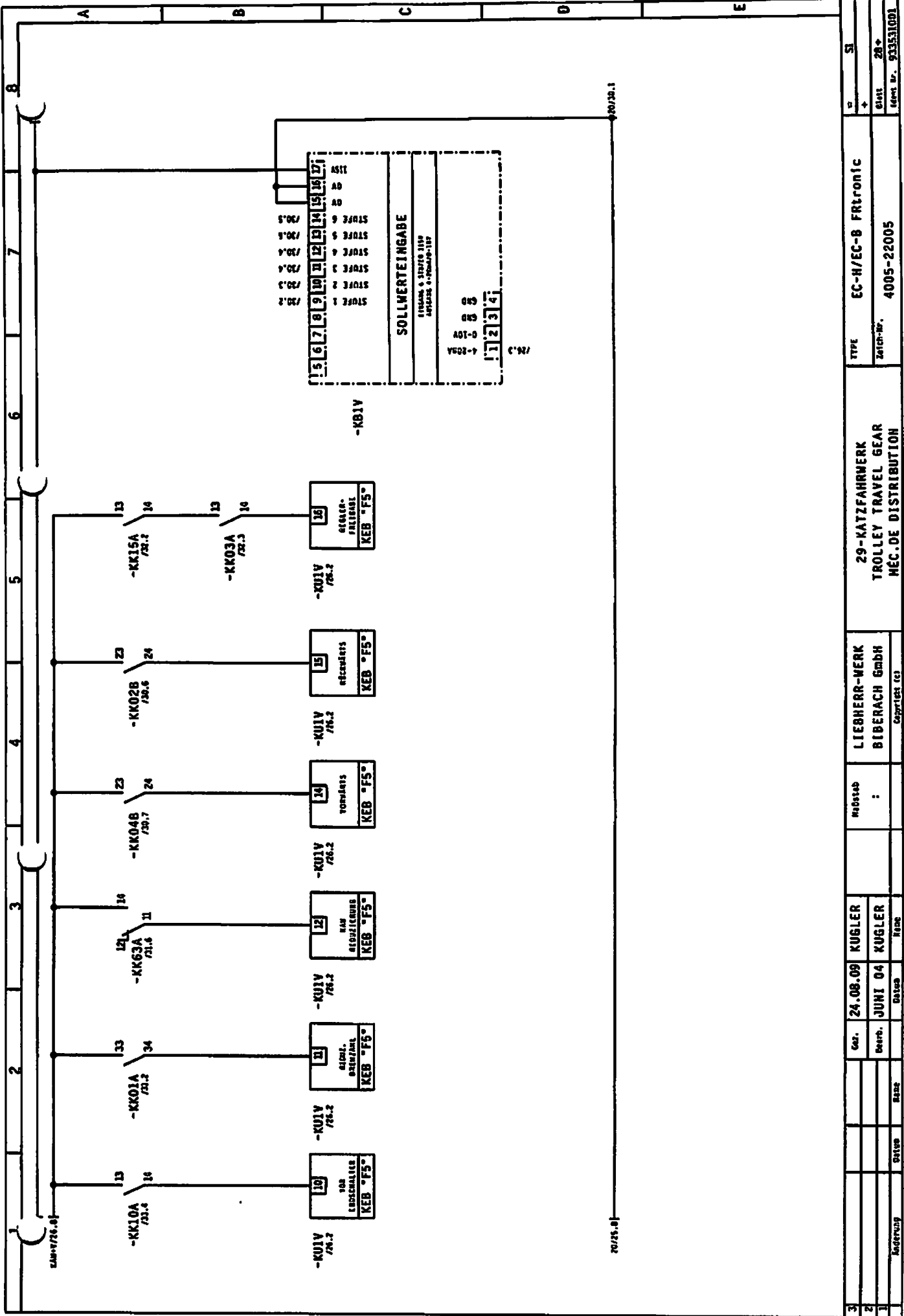

3	Gez.	24.08.09	KUGLER	Werkstatt	LIEBHERR-WERK BIBERACH GmbH		29-KATZFAHRWERK TROLLEY TRAVEL GEAR MÉC.DE DISTRIBUTION		TYPE	EC-H/EC-B Frtronic	SI
2	Datrb.	JUNI 04	KUGLER	:					Zeich.-Nr.	4005-22005	28+
1	Datum										Form. Nr. 933531001

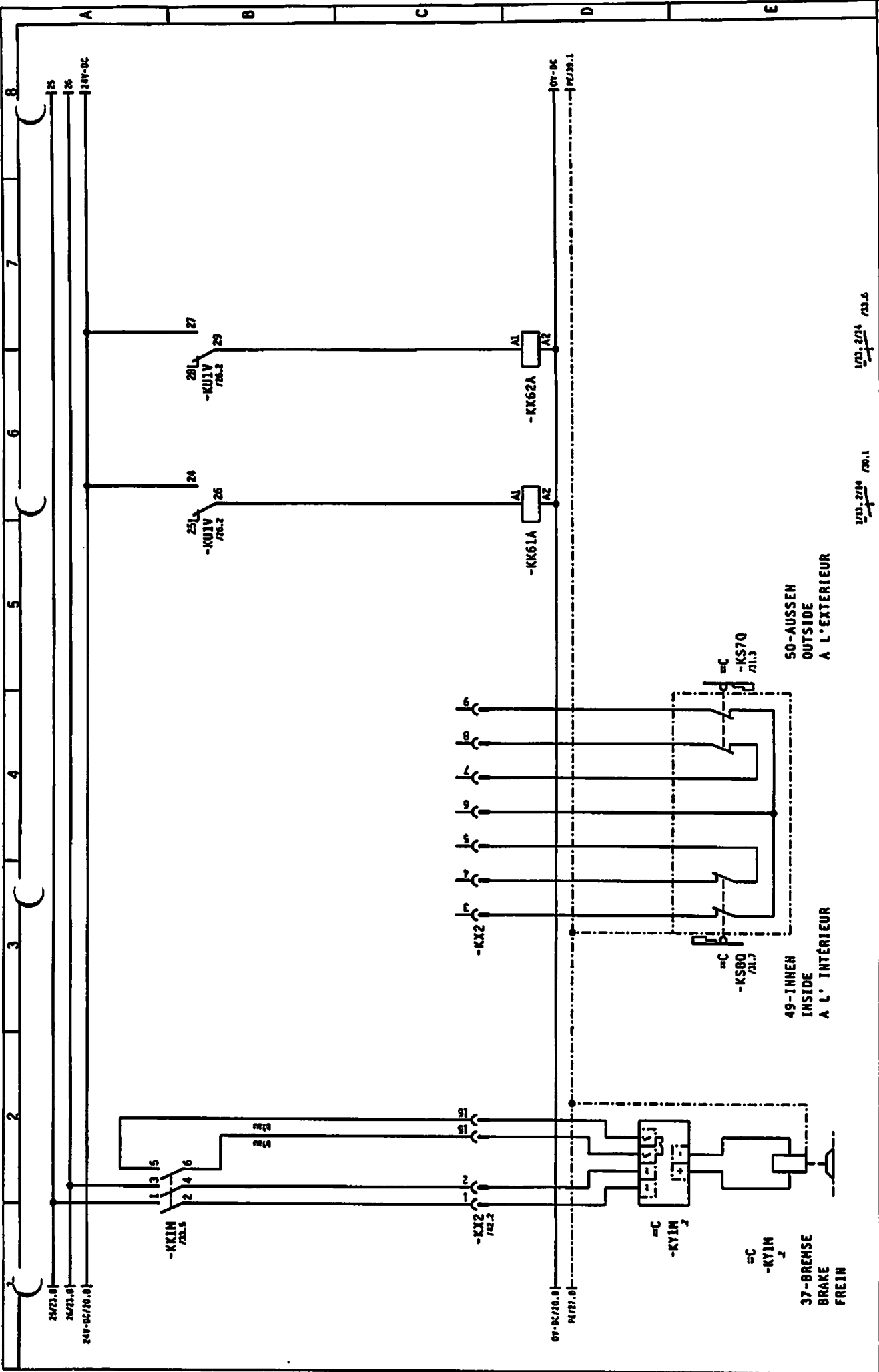

100.2714 / 733.6  
100.2714 / 733.1

3	100.2714	733.6	TYPE	EC-H/EC-B Frlromic	SL
2	100.2714	733.1	Zutich-Nr.	4005-22005	29+
1	24.08.09	KUGLER	29-KATZFAHRWERK TROLLEY TRAVEL GEAR MEC. DE DISTRIBUTION		
		Meistab	LIEBHERR-WERK BIEBRACH GmbH		
	24.08.09	KUGLER	Copyrights (c)		
		Beauf.	JUNI 04	KUGLER	
		Beauf.			
		Beauf.			
		Beauf.			





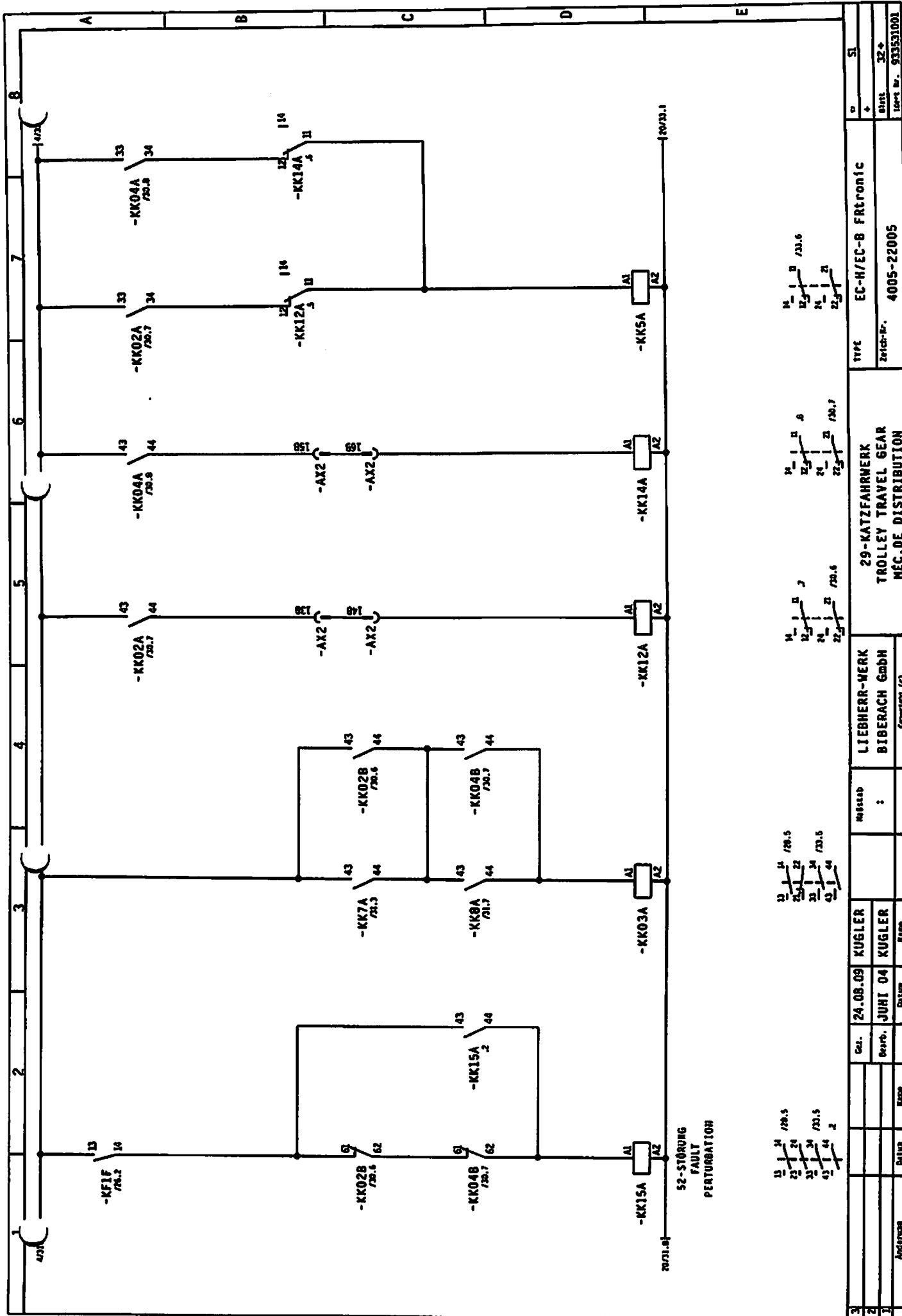

3	24.08.09	KUGLER	Mitarb	LIEBHERR-WERK BIBERACH GmbH	TYPE EC-H/EC-B FRFRONIC	SI
2	JUHI 04	KUGLER	;	29-KATZFÄHRWERK TROLLEY TRAVEL GEAR MÉC.DE DISTRIBUTION	Zeich-Nr. 4005-22005	32+
1				Gezeichnet (G)		Ident. Nr. 933531091
	Ordnung	Zeich	Blatt			

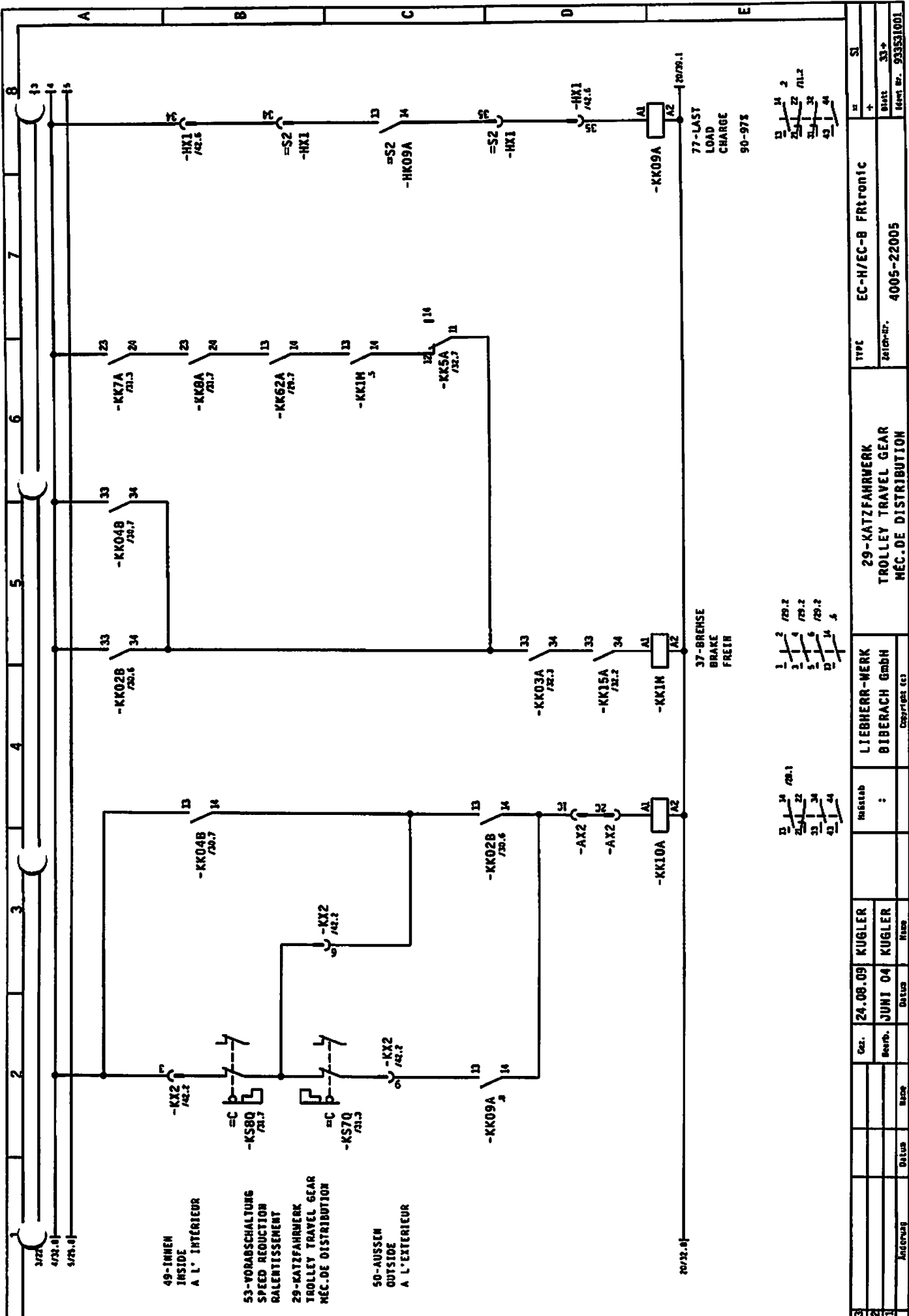

3	24.08.09	KUGLER	Revised	LIEBHERR-WERK BIBERACH GmbH		29-KATZFABRIK TROLLEY TRAVEL GEAR MEC-DE DISTRIBUTION		TYPE 4005-22005	EC-N/EC-B FRTronic	SI
2		JUNI 04	Dated					4005-22005		Blatt 33
1			Issue							Reviz. nr. 933531001

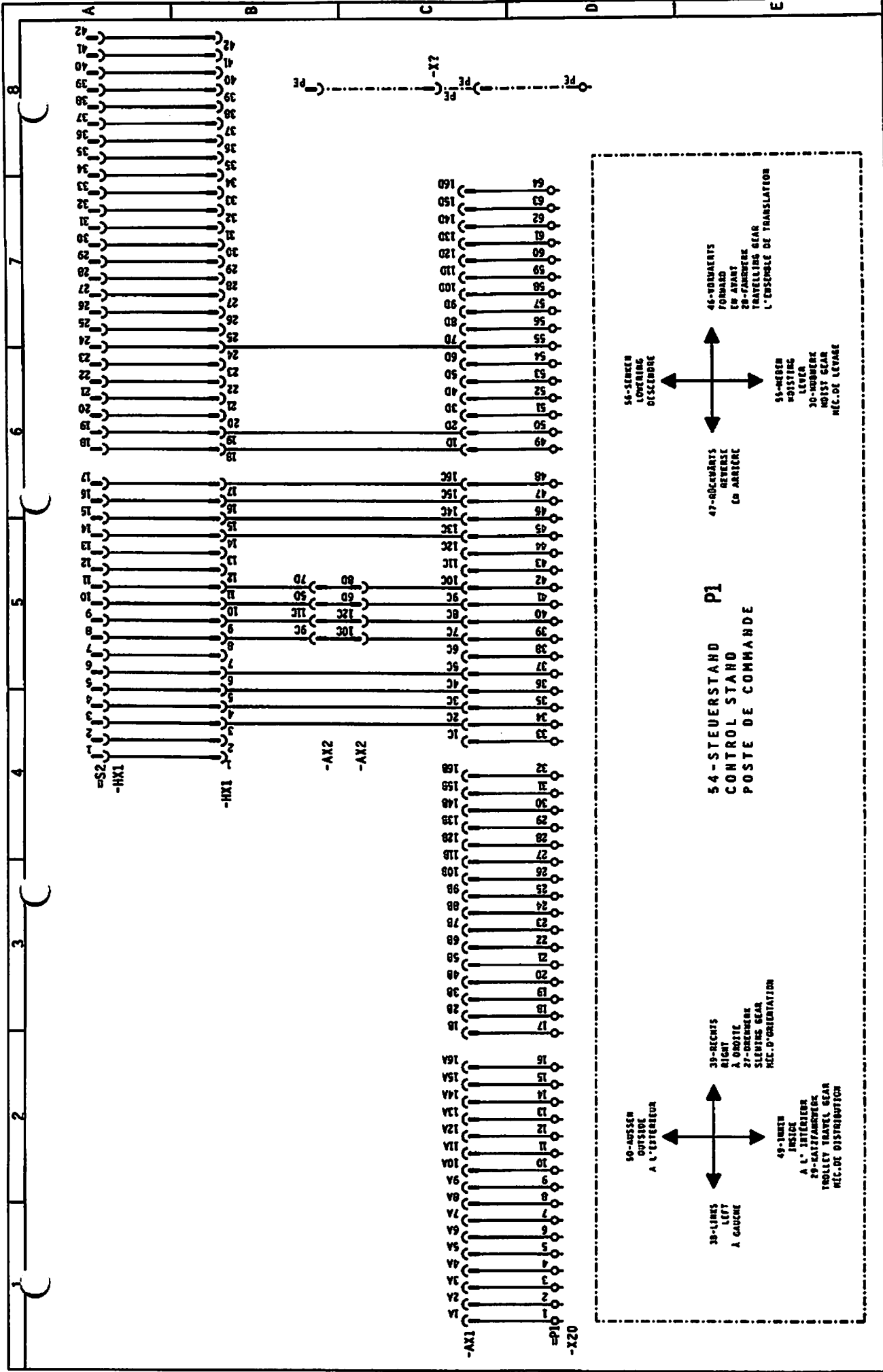

3	Ger.	24.08.09	KUGLER	Mastered	LIEBHERR-WERK BIBERACH GmbH	54-STEUERSTAND CONTROL STAND POSTE DE COMMANDE	TYPE	EC-H/EC-B Frtronic	SI
2	Umrp.	JUNI 04	KUGLER				Zeich.-Nr.	4005-22005	34+
1	Besch.								Best. Nr. 933531001
	Datum								
	Datum								
	Datum								





A		B		C		D		E	
3	2	3	4	5	6	7	8		
Zugriff		Datum	Blz	Gez.		24.08.09		KUGLER	
Antrag		Datum	Blz	Gez.		JUNI 04		KUGLER	
Name		: :		LIEBHERR-MERK		BIBERACH GmbH			
Beschreibung		: :		5-STECKVORRICHTUNG		PLUG-IN DEVICE			
Zusatz		: :		DISPOSITIF ENFICHABLE		4005-22005			
Typ		: :		EC-N/EC-B		FRTRONIC			
Menge		: :		+		SI			
Blatt		: :		36		+			
Blatt-Nr.		: :		933531001					

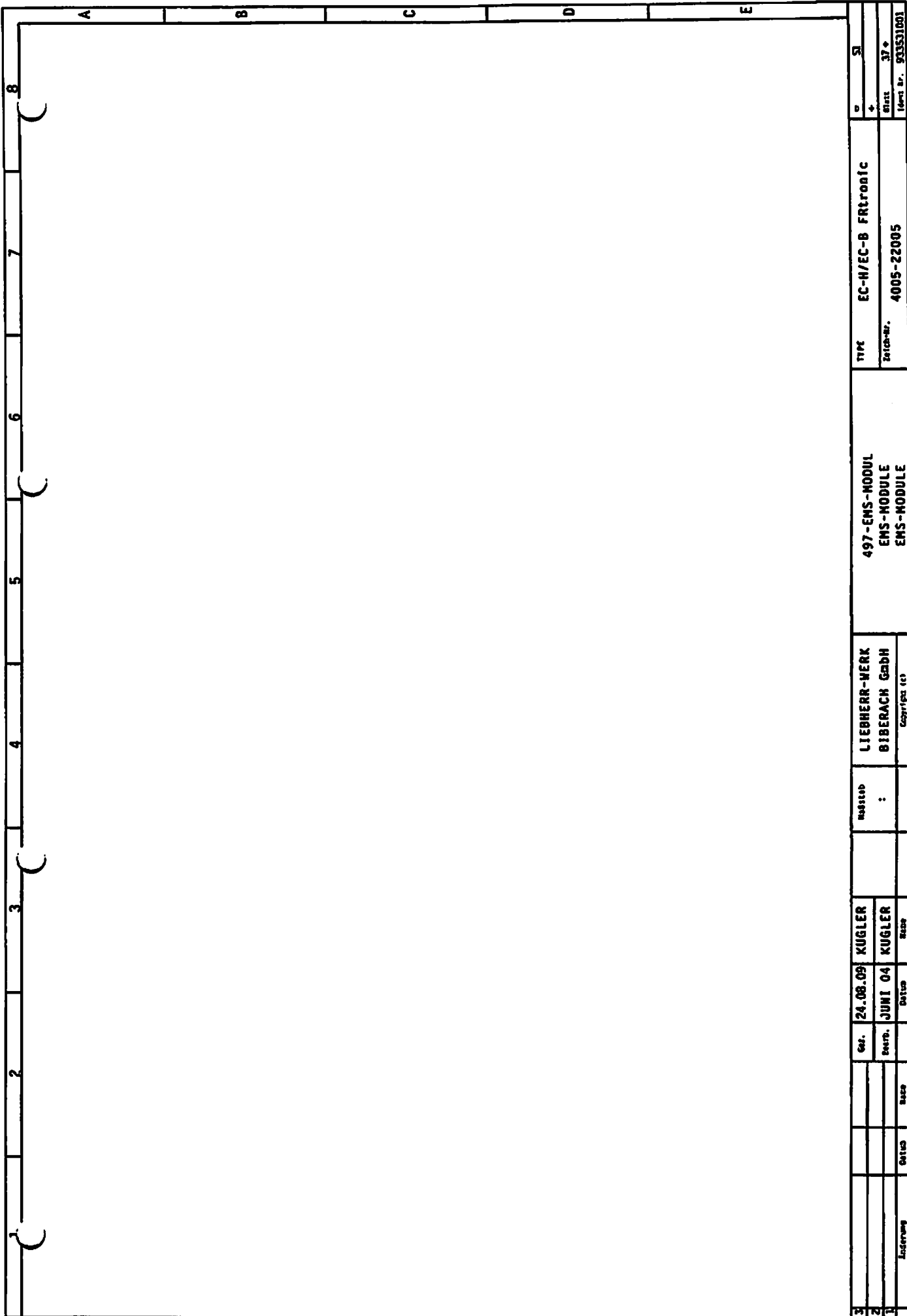

23

Bestimmung

Blatt

2

Blatt

1

Datum

Blatt

2

Verf.

24.08.09

Zeichner

KUGLER

Blatt

JUNI 04

Verf.

KUGLER

Blatt

:

Bestand

LIEBHERR-WERK  
BIBERACH GMBH

Blatt

4005-22005

Blatt

497-EMS-MODUL  
EMS-MODULE  
EMS-MODULE

Blatt

Blatt

Blatt

Blatt

Blatt

Blatt

Blatt

Blatt

Blatt

Blatt

Blatt

Blatt

Blatt









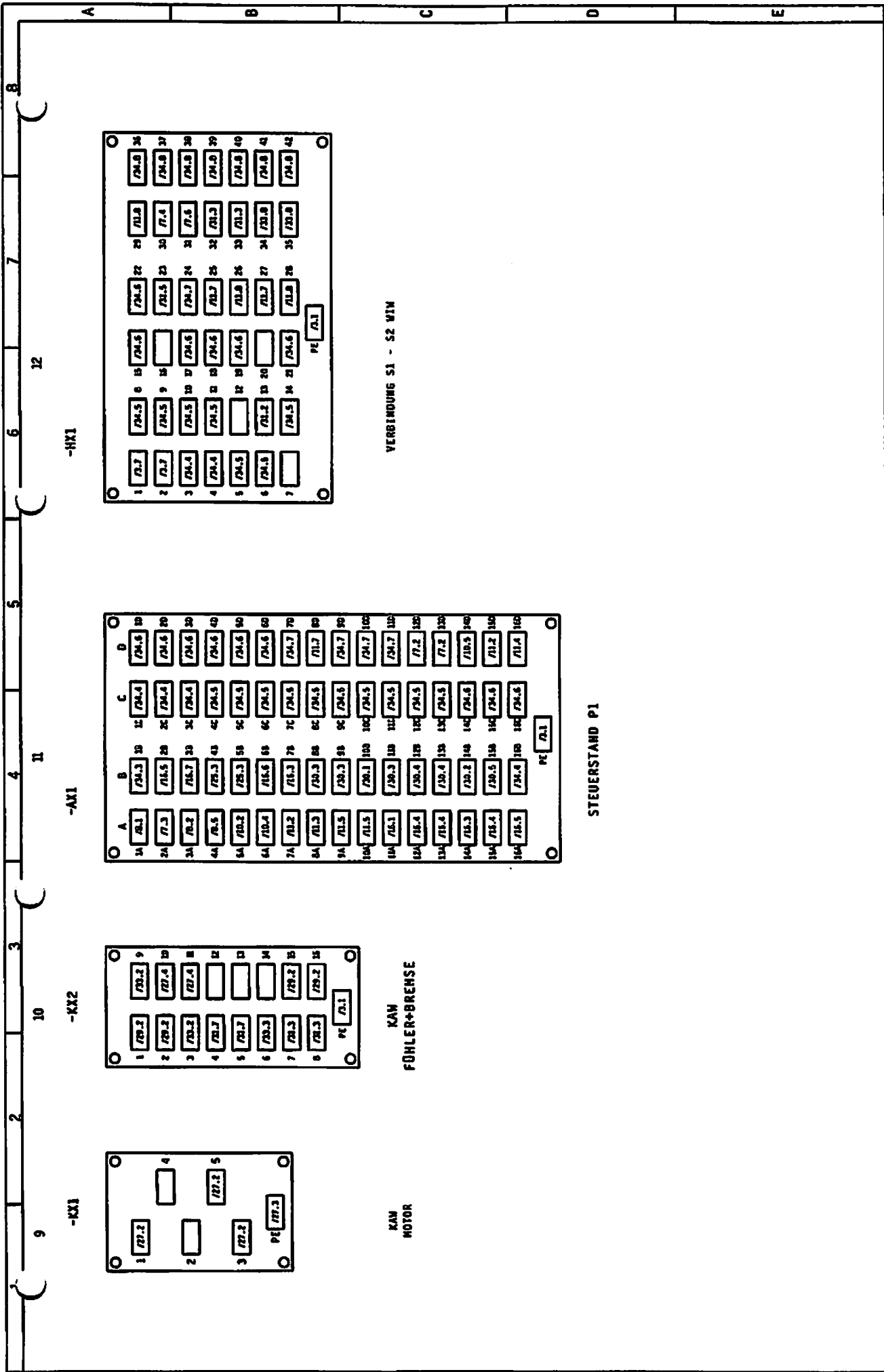

3)			Gez. 24.08.09	KUGLER	Herstell	LIEBHERR-WERK BIBERACH GmbH	5-STECKVORRICHTUNG PLUG-IN DEVICE DISPOSITIF ENFICHABLE	TYPE Zaich-nr.	EC-H/EC-B FRTRONIC 4005-22005	SI
2)			Bauh. JUNI 04	KUGLER	:	810000				Plus 42+
1)					Datum	Datum				Ident. nr. 935531001

KAN MOTOR

KAN FÜHLER+BREMSE

STEUERSTAND P1

VERBINDUNG S1 - S2 WIN



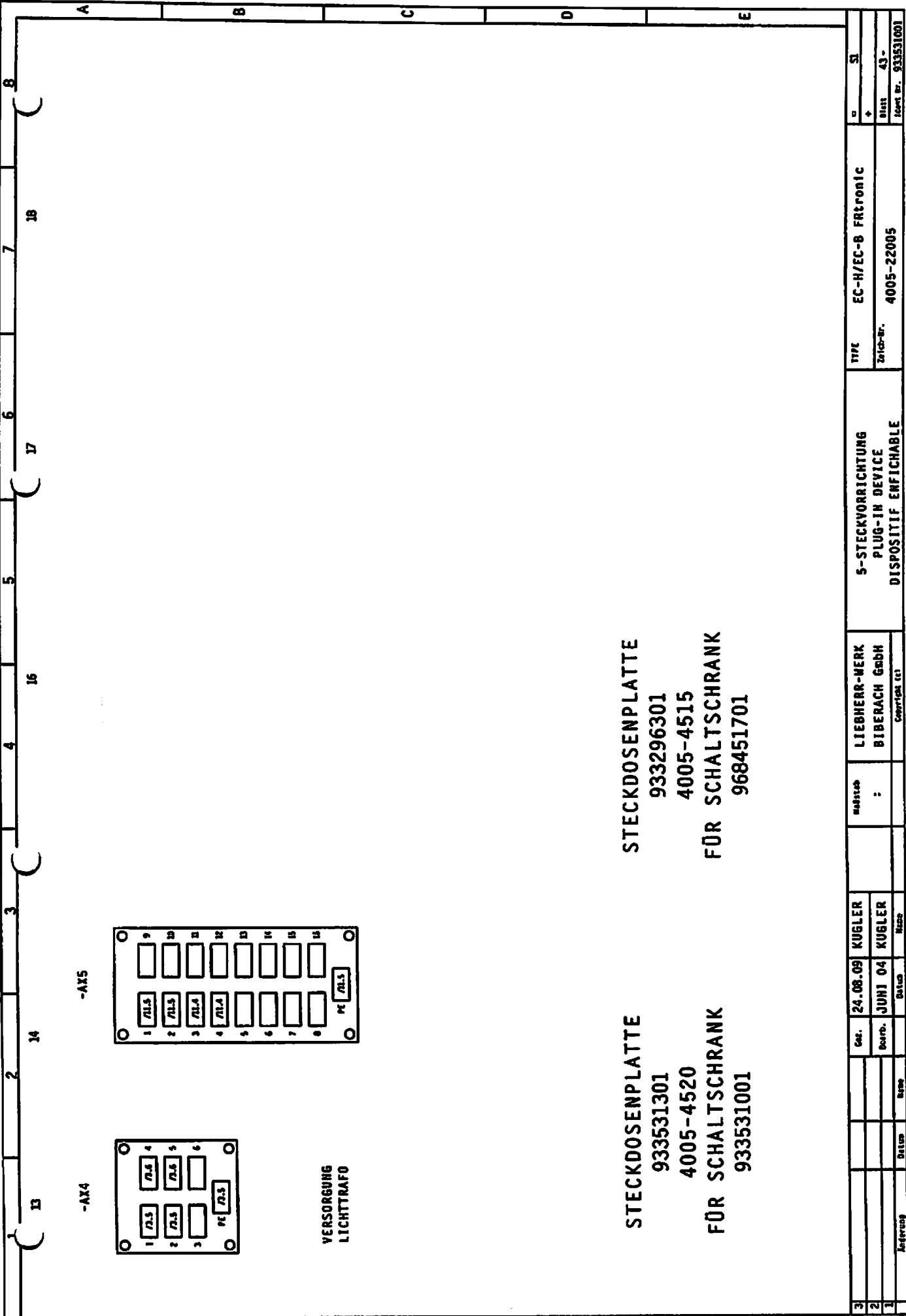

-AX4

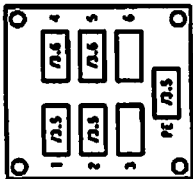

-AX5

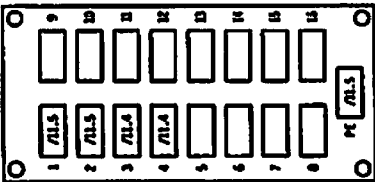

VERSORGUNG  
LICHTTRAFO

STECKDOSENPLATTE  
933531301  
4005-4520  
FÜR SCHALTSCHRANK  
933531001

STECKDOSENPLATTE  
933296301  
4005-4515  
FÜR SCHALTSCHRANK  
968451701

3				cat.	24.08.09	KUGLER	Hersteller	LIEDHERR-WERK BIBERACH GMBH	5-STECKVORRICHTUNG PLUG-IN DEVICE DISPOSITIF ENFICHABLE	TYPE EC-H/EC-B FRETRONIC Zeich.-Nr. 4005-22005	SI Blatt 43 - Ident. Nr. 933531001
2				descr.	JUNI 04	KUGLER	;				
1				name							