

* = NICHT SERIENMÄSSIG
 NOT STANDARD
 PAS STANDARD

SCHIRM ÜBER EINBRUSTECKER
 AM SCHALTSCHRANK
 SHIELD CONNECTED WITH CABINET
 BLIND FICHE ENCAST
 A L'ARM ELECTR

3		07.02.00	Ernte			LIEBHERR-WERK BIBERACH GmbH		EINSPEISUNG SUPPLY ALIMENTATION		TYPE EC-H/EC-B 30/37/45KW,FU *	S2
2		07.02.00	Ernte							Zersch-Nr. 4005-21834	
1										Blatt 1+	
										Ident. Nr. 30865501	

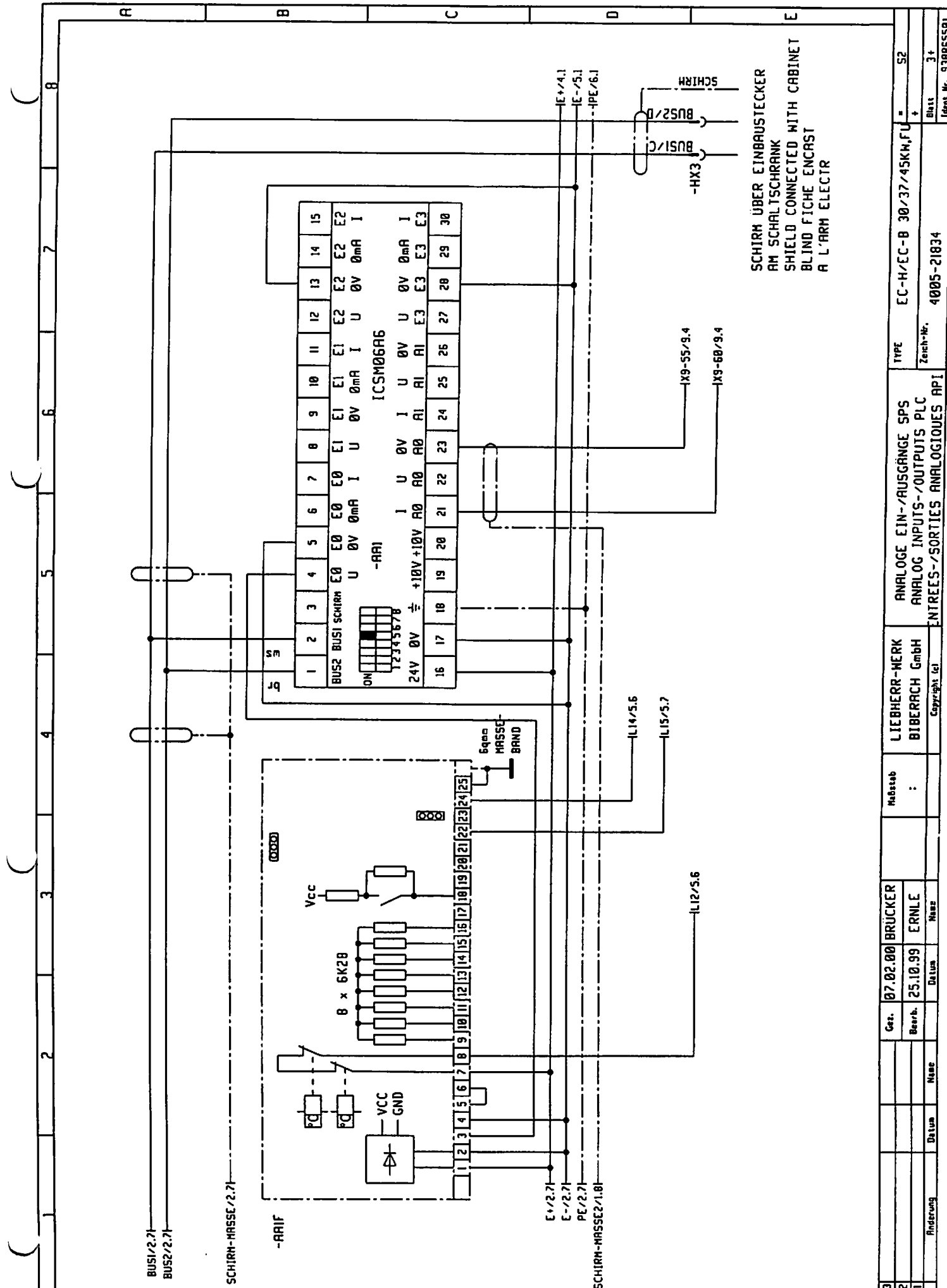

SCHIRM ÜBER EINBRUSTECKER
 AM SCHALTSCHRANK
 SHIELD CONNECTED WITH CABINET
 BLIND FICHE ENCAST
 A L'ARM ELECTR

3		07.02.00		BRÜCKER		LIEBHERR-WERK		ANALOG E IN-/AUSGÄNGE SPS		TYPE		S2	
2		25.10.99		ERNLE		BIBERACH GmbH		ANALOG INPUTS-/OUTPUTS PLC		EC-H/EC-B 30/37/45KW,FU		+	
1						Copyright Ict		ENTREES-/SORTIES ANALOGIQUES API		Zeich-Nr.		Blatt	
										4005-21874		3+	
										Ident. Nr.		930065501	

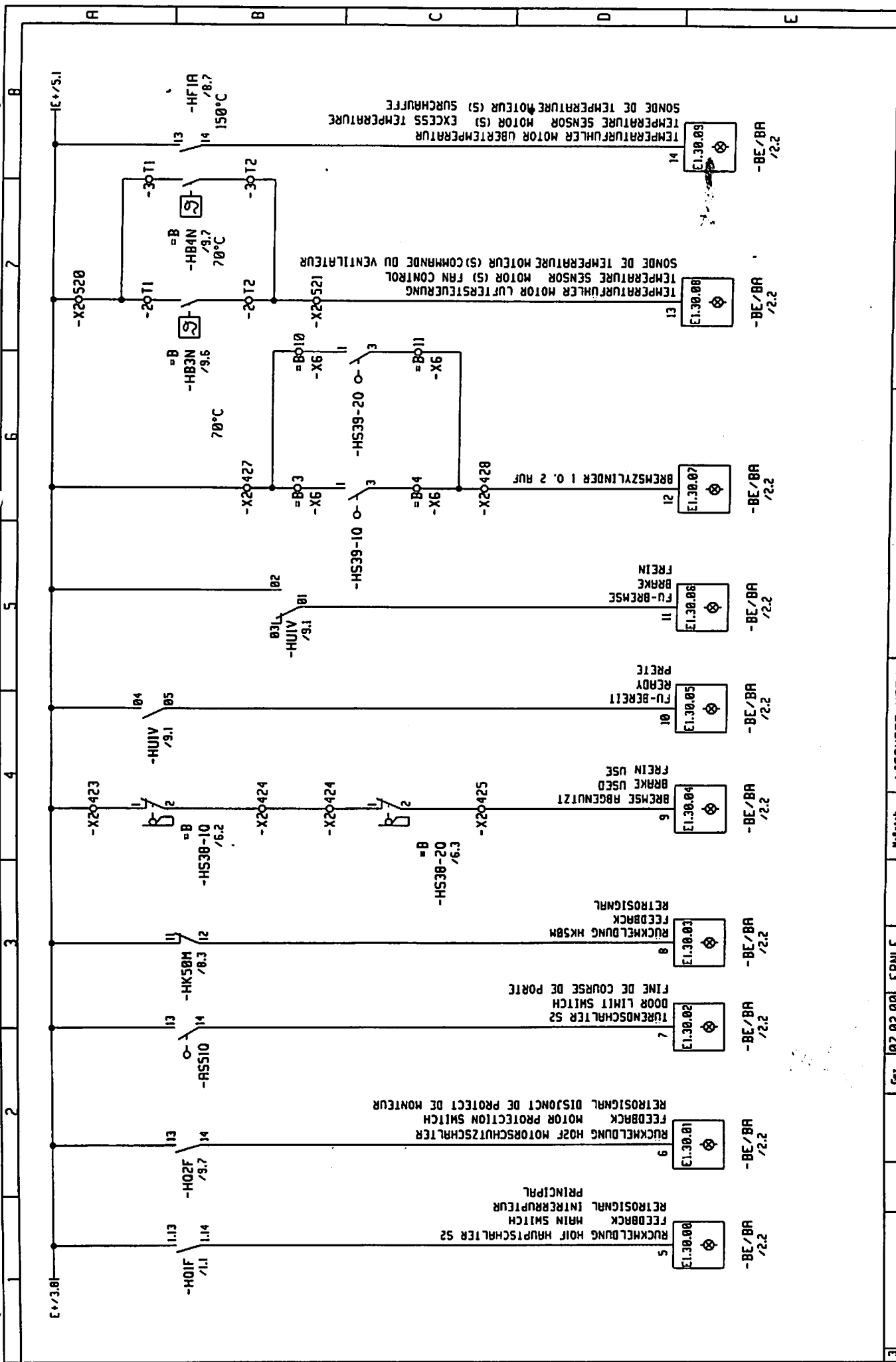

Änderung		Datum	Name	Datum		Name	Masseub		LIEBHERR-MERK		BINÄRE EINGÄNGE SPS		TYPE		Blatt		Ident. Nr.	
3														EC-H/EC-B 30/37/45KN,FL	S2	4+	938055501	
2																		
1																		
		Gez.	07.02.00	ERNLE						BIBERACH GmbH		Zweck-Nr.		4005-21034				
		Beurb.	07.02.00	ERNLE	Name					Copyright (c)		Typ		30/37/45KN,FL				
					Datum					LIEBHERR-MERK		Zweck-Nr.		4005-21034				
					Name					BIBERACH GmbH		Typ		30/37/45KN,FL				
					Datum					LIEBHERR-MERK		Blatt		4+				938055501
					Name					BIBERACH GmbH		Ident. Nr.		938055501				

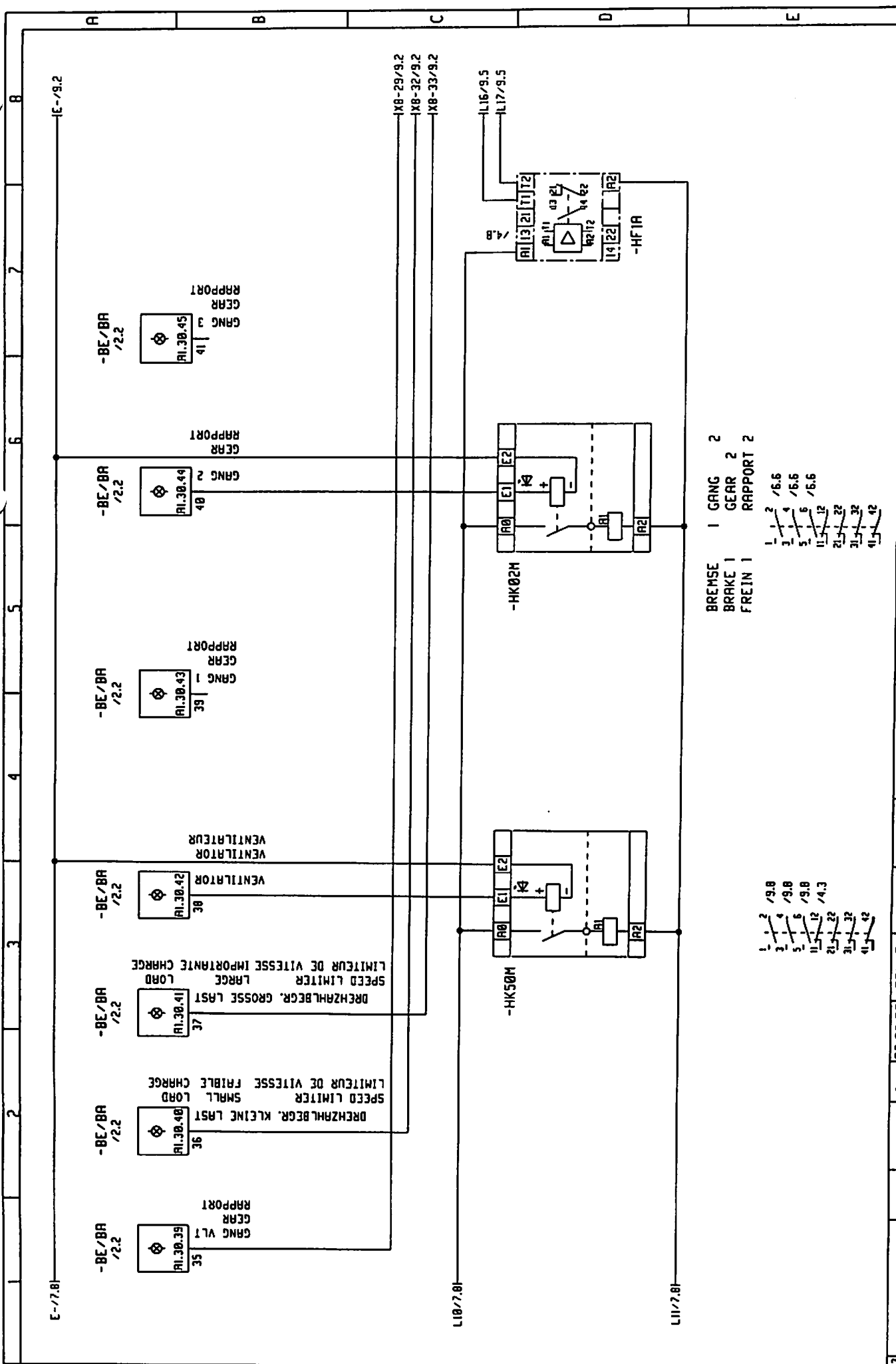

- BREMSE 1 GANG 2
- BRAKE 1 GEAR 2
- FREIN 1 RAPPOR 2
- L 1 2 / 9.8
- L 2 4 / 9.8
- L 3 5 / 9.8
- L 4 6 / 9.8
- L 5 11 / 12 / 4.3
- L 6 21 / 22
- L 7 31 / 32
- L 8 41 / 42

3		Gez.	07.02.00	ERNLE	Modell	LIEBHERR-MERK	BINARE AUSGANGS SPS		TYPE	EC-H/EC-B 30/37/45KH, FU	S2
2		Bearb.	25.10.99	ERNLE		BIBERACH GmbH	BINARY OUTPUTS PLC		Zeich.-Nr.	4005-21834	B+
1						Copyright tel	SORTIES BINAIRES API		Ident. Nr.	93086550	

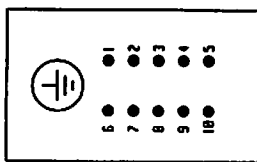
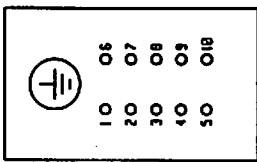

LEGENDE HX1

- 1
- 2 0/110V
- 3 110V DRAUER
- 4
- 5
- 6
- 7 110V GESCHALTET
- 8
- 9
- 10

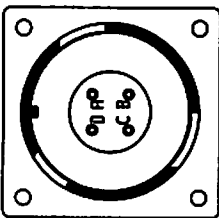

HX3

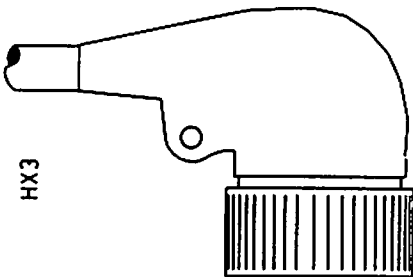

LEGENDE HX3

- A BUS 1 KOMMT
- B BUS 2 KOMMT
- C BUS 1 GEHT
- D BUS 2 GEHT

C
C
C
C
C
C
C
C
C
C

A B C D E

3				Ernle	07.02.00	ERNLE	Hubstob	LIEBHERR-MERK	STECKER	PLATTE	HUBWERK	TYPE	EC-H/EC-B 30/37/45KH,FU	S2
2				Ernle	25.10.99	ERNLE	:	BIBERACH GmbH	PLUG	PLATE	HOIST GEAR			+
1				Ernle		ERNLE			FICHE	PLAQUE	MEC. DE LEVAGE	Zeich.-Nr.	4005-21034	Blatt 10+
				Änderung	Datum	Name						Ident. Nr. 930865501		

ANSICHT X

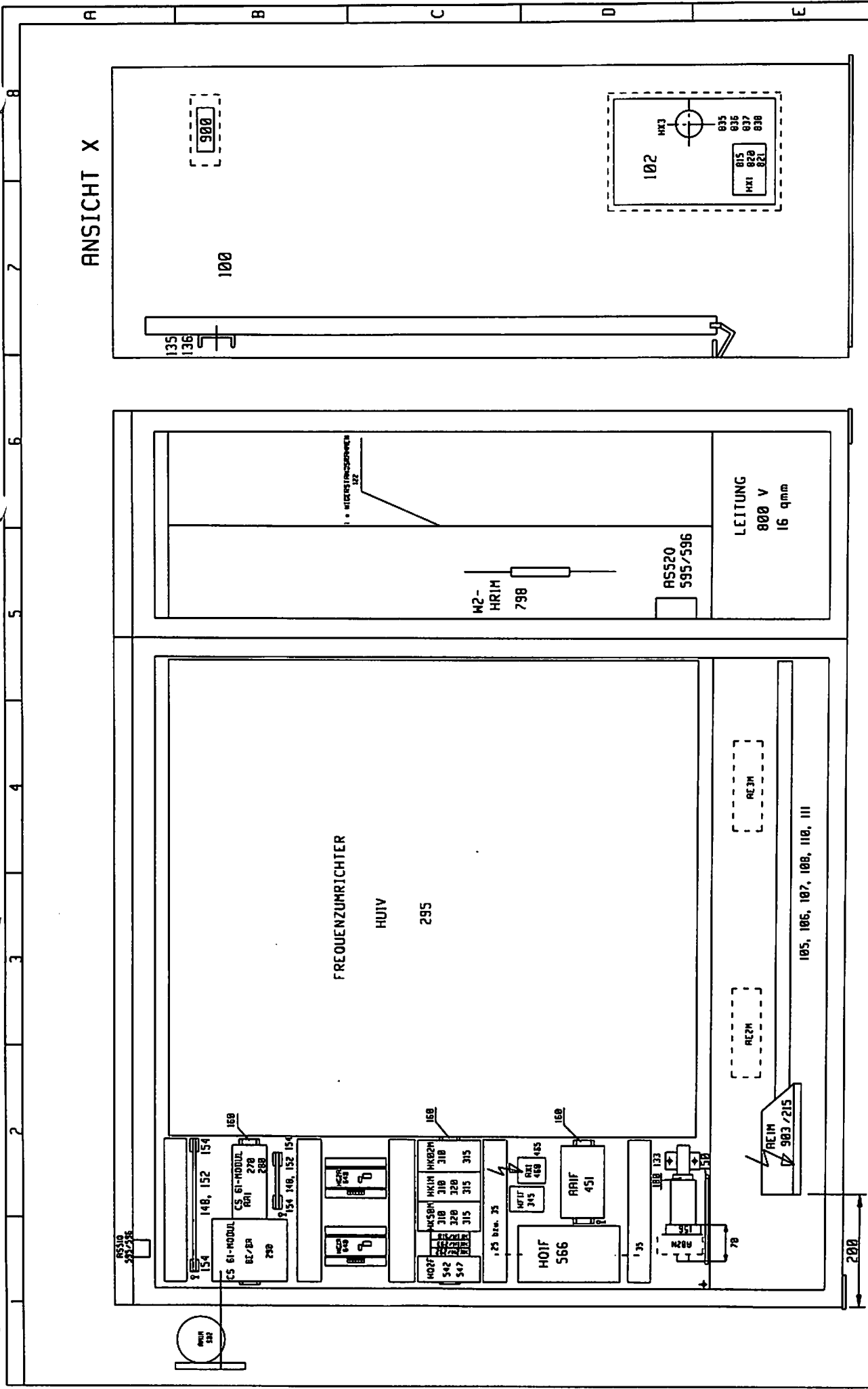

Änderung	Datum	Name	Gez.	14.12.99	ERNLE	Maßstab	LIEBHERR-WERK BIBERACH GmbH	GERÄTEANORDNUNG	TYPE	S2 37/45KW FU 2-GANG	Blatt	52
3												
2												
1			Bearb.	15.12.99	ERNLE	:			Zeich.-Nr.	4005-81928		
			Datum		Name		Copyright (c)					
												Ident. Nr. 93065601