

3		Ger.	09.04.98											TYPE	80/112/140 EC-B/EC-H	SI		
2		Beerbh.	09.02.98	ELLINGER										Zeich.-Nr.	4005-21761	Blatt	1	
1																	Best.-Nr.	611680381
	Reduzierung		Datum	Revise	Revise	Revise	Revise											
			LIEBHERR-WERK			BIBERACH GmbH			Copyright ©									

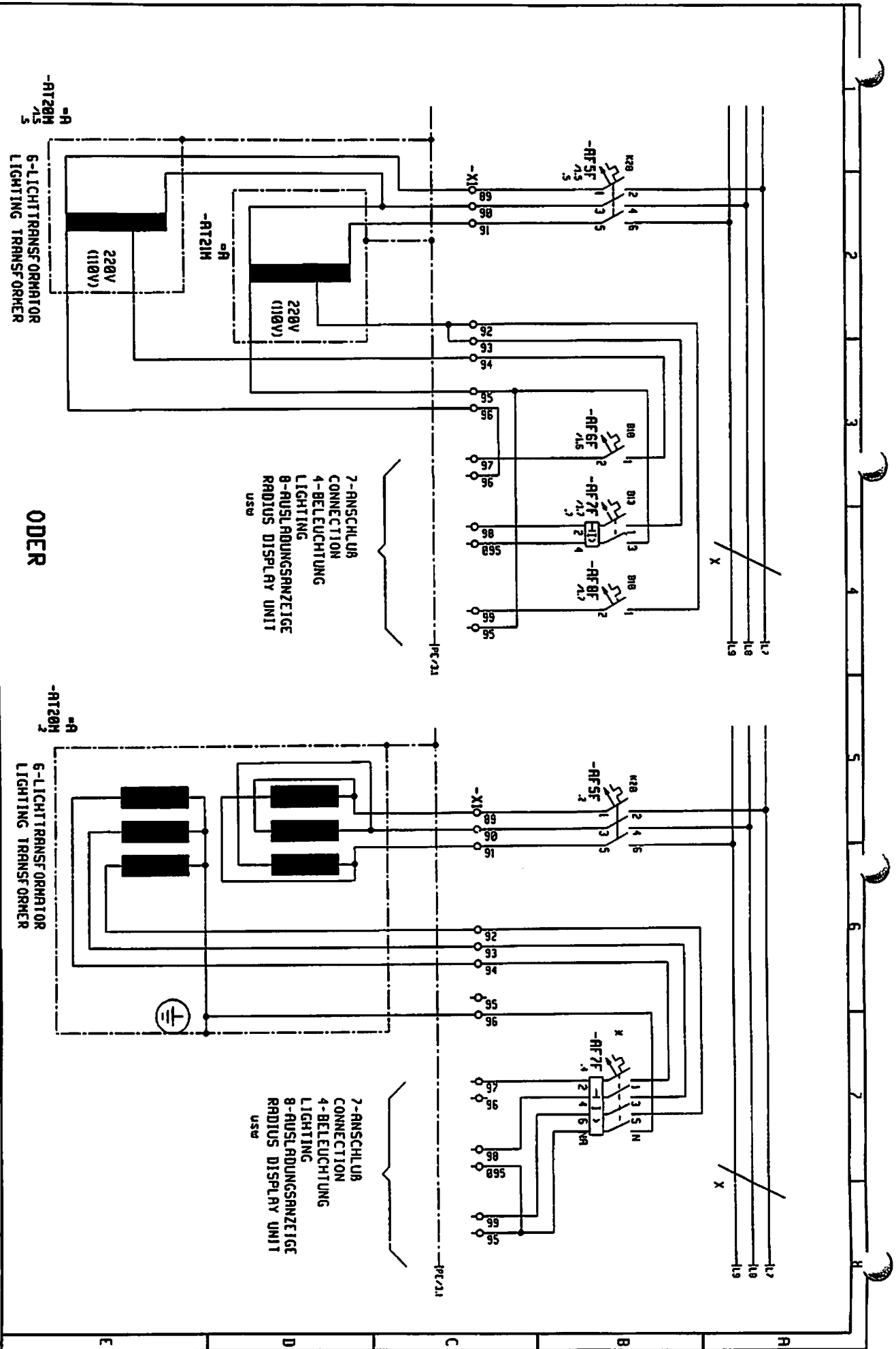

**ODER**

3	Car.	09.04.98	Relais	LIEBHERR-MERK	Typ	80/112/140 EC-B/E/C-H	SI
2	Bech.	09.02.98	Ellinger	BIBERACH GmbH	Zust.-Nr.	1005-21751	21
1	Hersteller	Ort	Rev.	Gezeichnet			Ident. Nr. 51529381



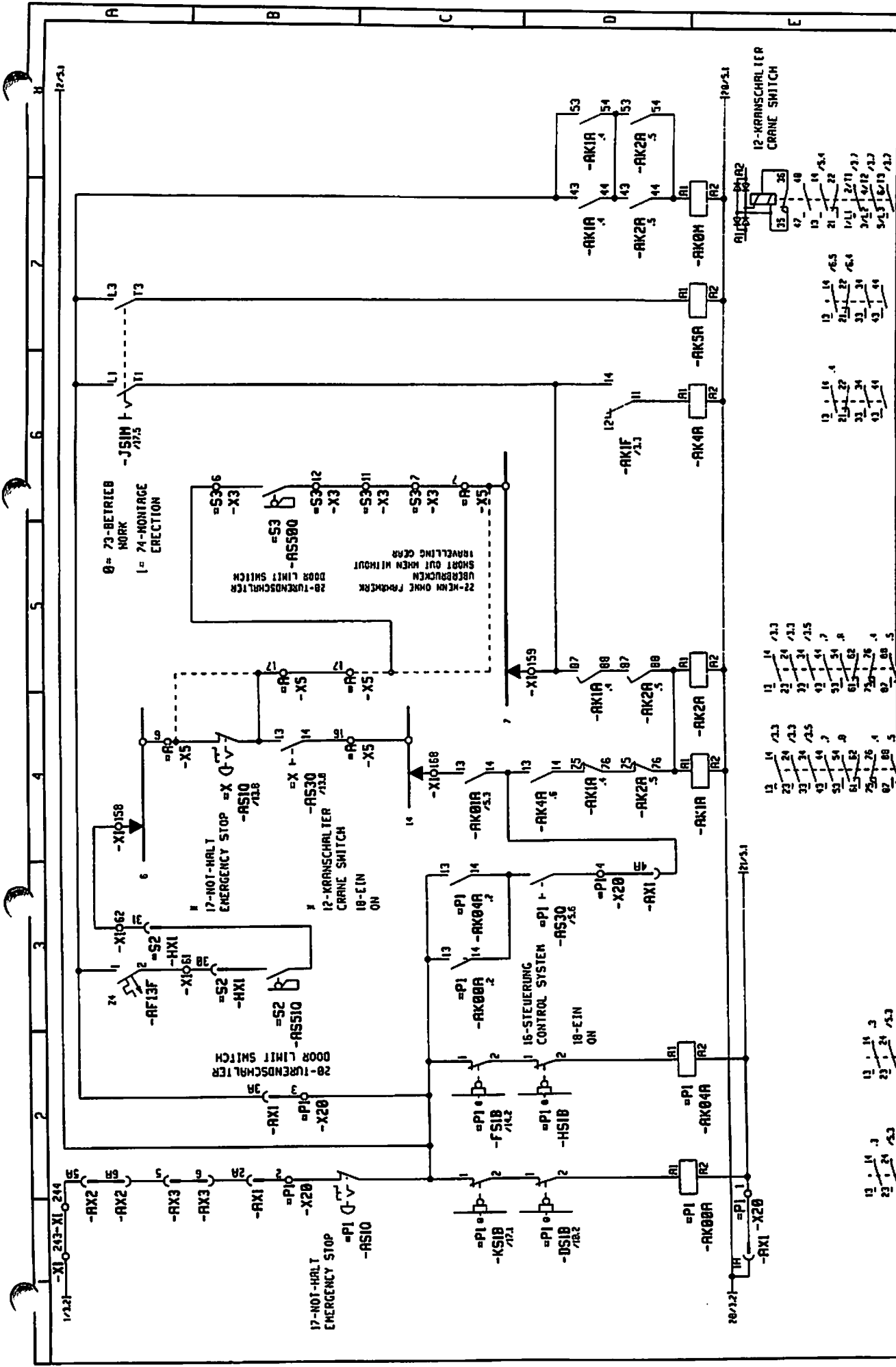

3	Gen.	09.04.98			Maßstab	LIBEHRER-WERK BIBERACH GmbH		16-STEUERUNG CONTROL SYSTEM		TYPE	80/112/140 EC-B/EC-H	SI	
2	Bearb.	09.02.98	ELLINGER		:					Zaeh-Nr.	4005-21761	Blatt	41
1	Datum		Datum	Reise	Copyright 03						Blatt Nr.	611606981	

0 = 73-BETRIEB  
NORK  
1 = 74-MONTAGE  
ERECTION

22-KEIN OHNE FANWERK  
UEBERBUCKEN  
SHORT OUT WHEN WITHOUT  
28-TURENSCHWELTER  
DOOR LIMIT SWITCH

17-NOT-HALT  
EMERGENCY STOP  
-AS10

28-TURENSCHWELTER  
DOOR LIMIT SWITCH

16-STEUERUNG  
CONTROL SYSTEM  
-AS30

17-NOT-HALT  
EMERGENCY STOP  
-AS10

12-KRANSCHALTER  
CRANE SWITCH

12	14	13	11	14	13
22	24	23	22	24	23
32	34	35	32	34	35
42	44	47	42	44	47
52	54	58	52	54	58
62	64	68	62	64	68
72	76	76	72	76	76
82	88	88	82	88	88
92	98	98	92	98	98

12	14	14
22	24	22
32	34	34
42	44	44
52	54	54
62	64	64
72	76	76
82	88	88
92	98	98

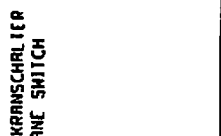

12-KRANSCHALTER  
CRANE SWITCH

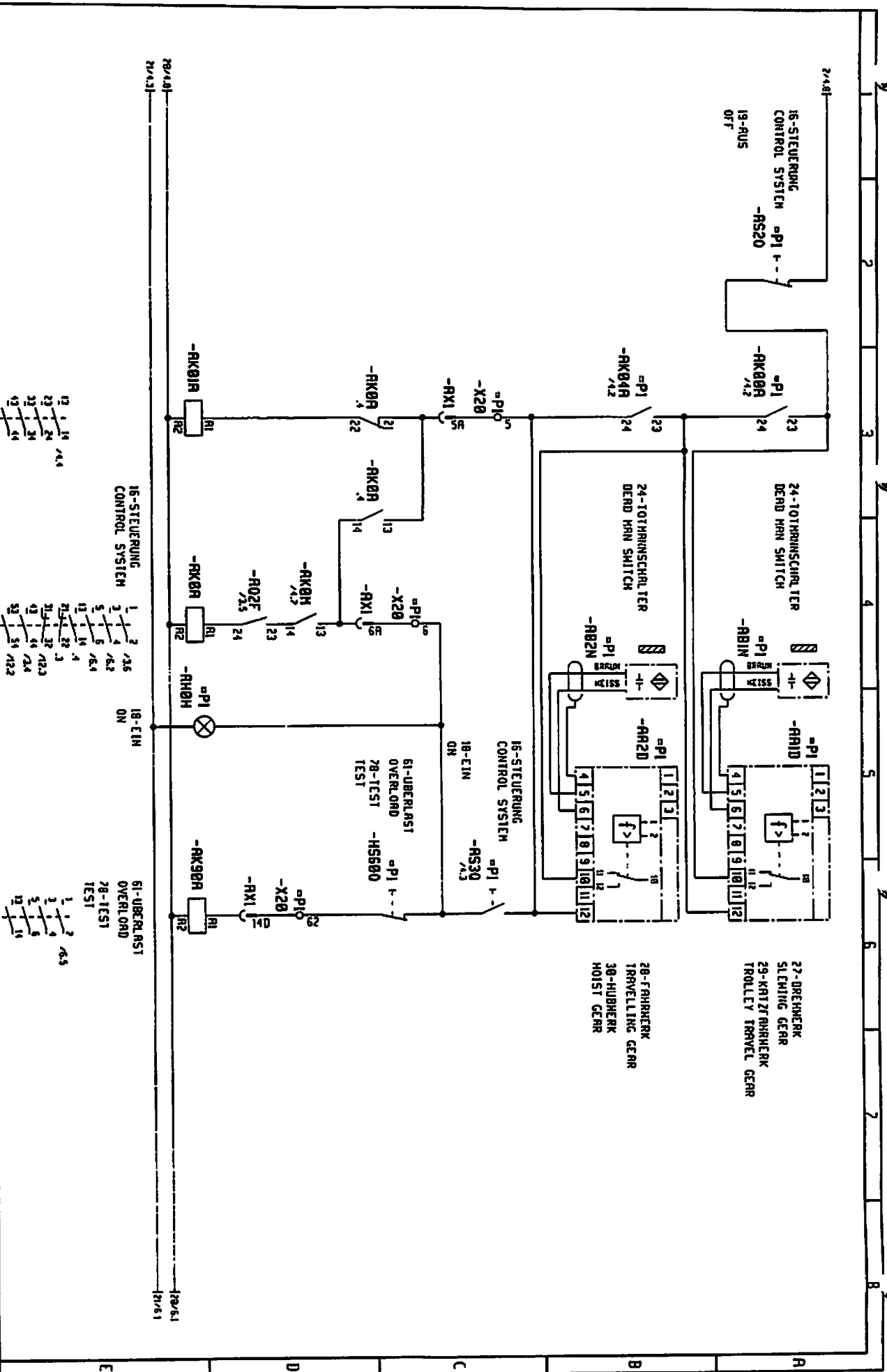

1	2	3	4	5	6	7	8
1	2	3	4	5	6	7	8
1	2	3	4	5	6	7	8
1	2	3	4	5	6	7	8
1	2	3	4	5	6	7	8
1	2	3	4	5	6	7	8
1	2	3	4	5	6	7	8
1	2	3	4	5	6	7	8
1	2	3	4	5	6	7	8

SI

Date: 5.1

Plant No. 61509301

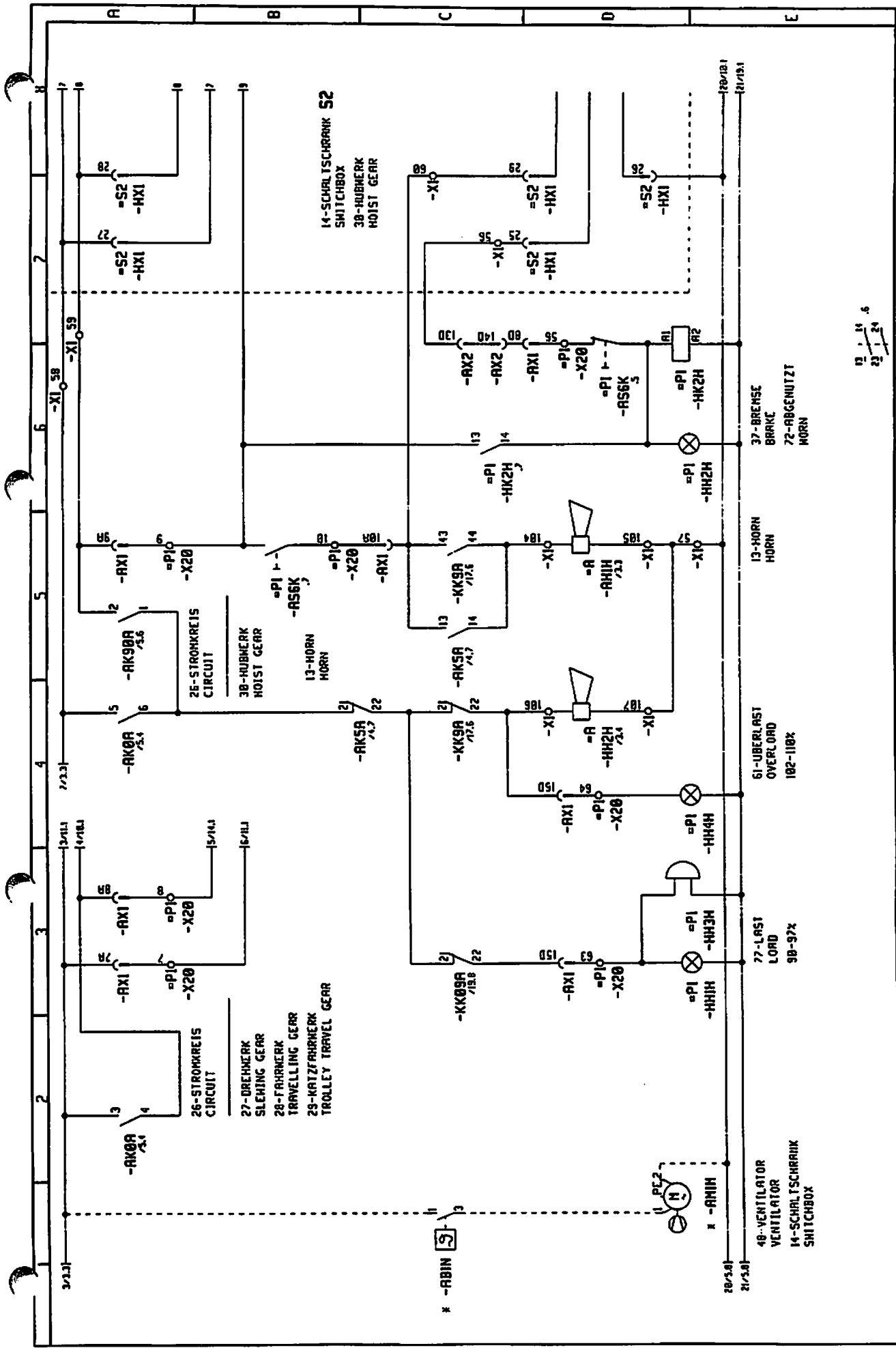

12 14 16  
22 1 24 6

3	Gez.	09.04.98	Modusub	LIEBHERR-MERK		26-STROMKREIS CIRCUIT	TYPE 80/112/140 EC-B/EC-H Zust.-Nr. 4005-21761	SI
2	Bearb.	09.02.98		BIBERACH GmbH				
1	Rev.			Copyright 1998				
1	Rev.						Mont. Nr. 611668381	

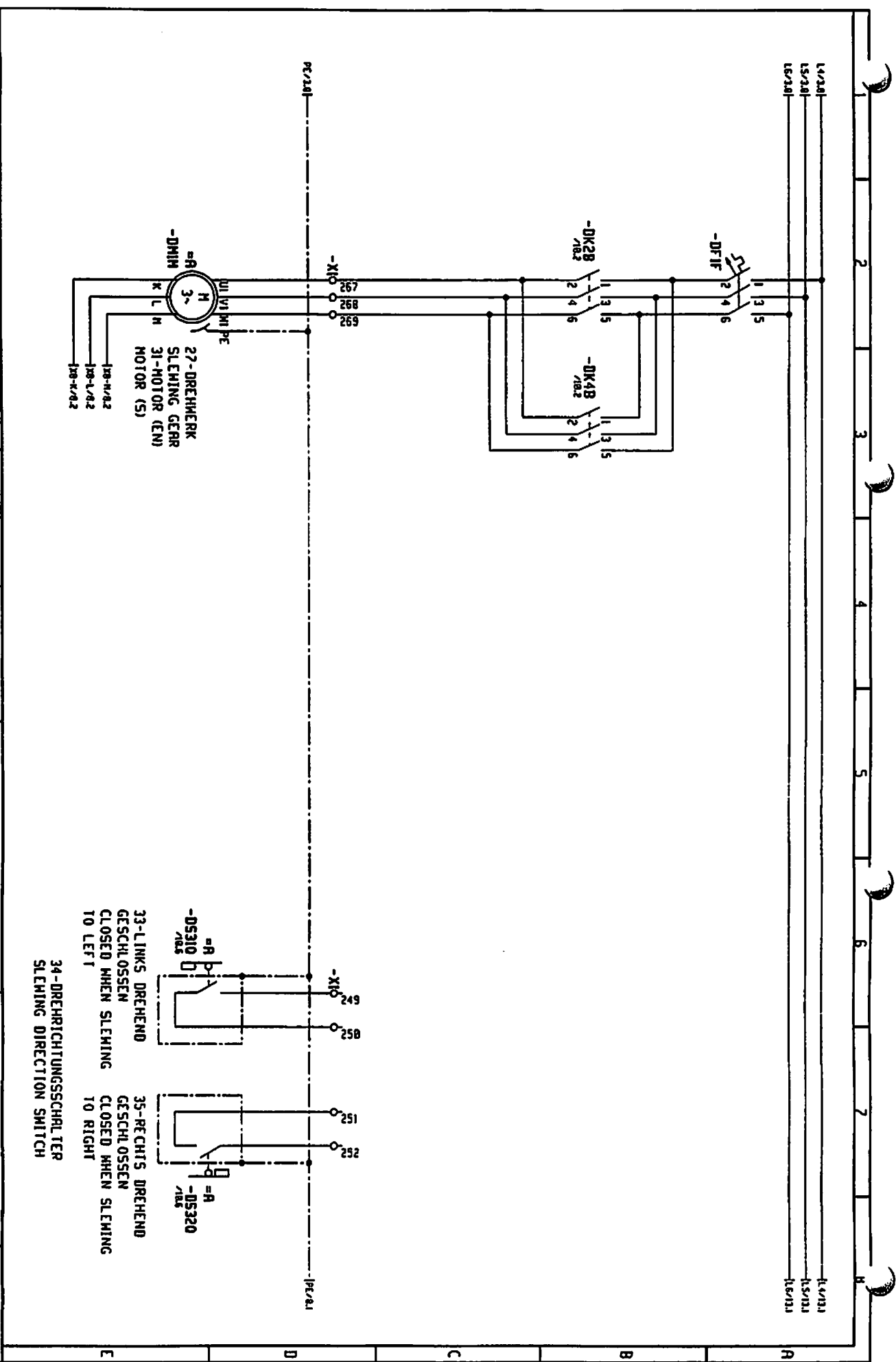

3																			
2																			
1																			
Hersteller		Datum		Name		Gew.		Ser.		Hersteller		Typ		Zust.-Nr.		Blatt		Ident. Nr.	
Hiltner						09.04.98		09.02.98		LIEBHERR-MERK BIEBRACH GmbH		27-DREHMERK SLEWING GEAR		80/112/140 EC-B/EC-H		74		51500981	

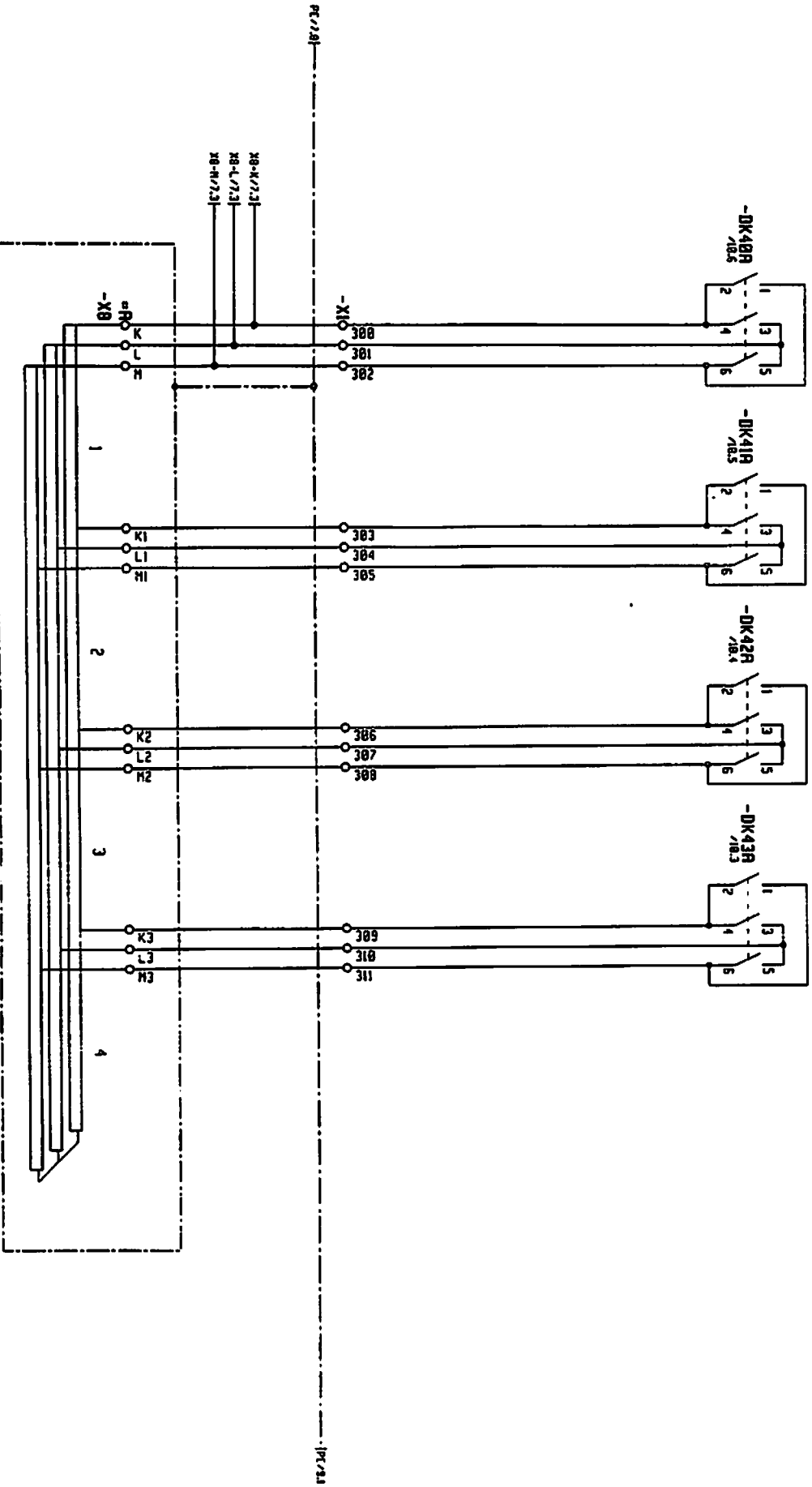

MIDRIN  
32-WIDERSTANDSSCHRANK  
RESISTOR BOX

3	Car.	09.04.98	Maßstab	1:1	LIEBHERR-MERK	27-DREHMERK SLEHING GEAR	TYPE 80/112/140 EC-B/EC-H	SI
2	Gezeichnet	09.02.98	FILLINGER		BIEBERGCH GbH			
1	Datum				Gezeichnet von		Zusch.-Nr. 4005-21761	Date 8.4
1	Datum				Gezeichnet von		Dokument Nr. 61609301	



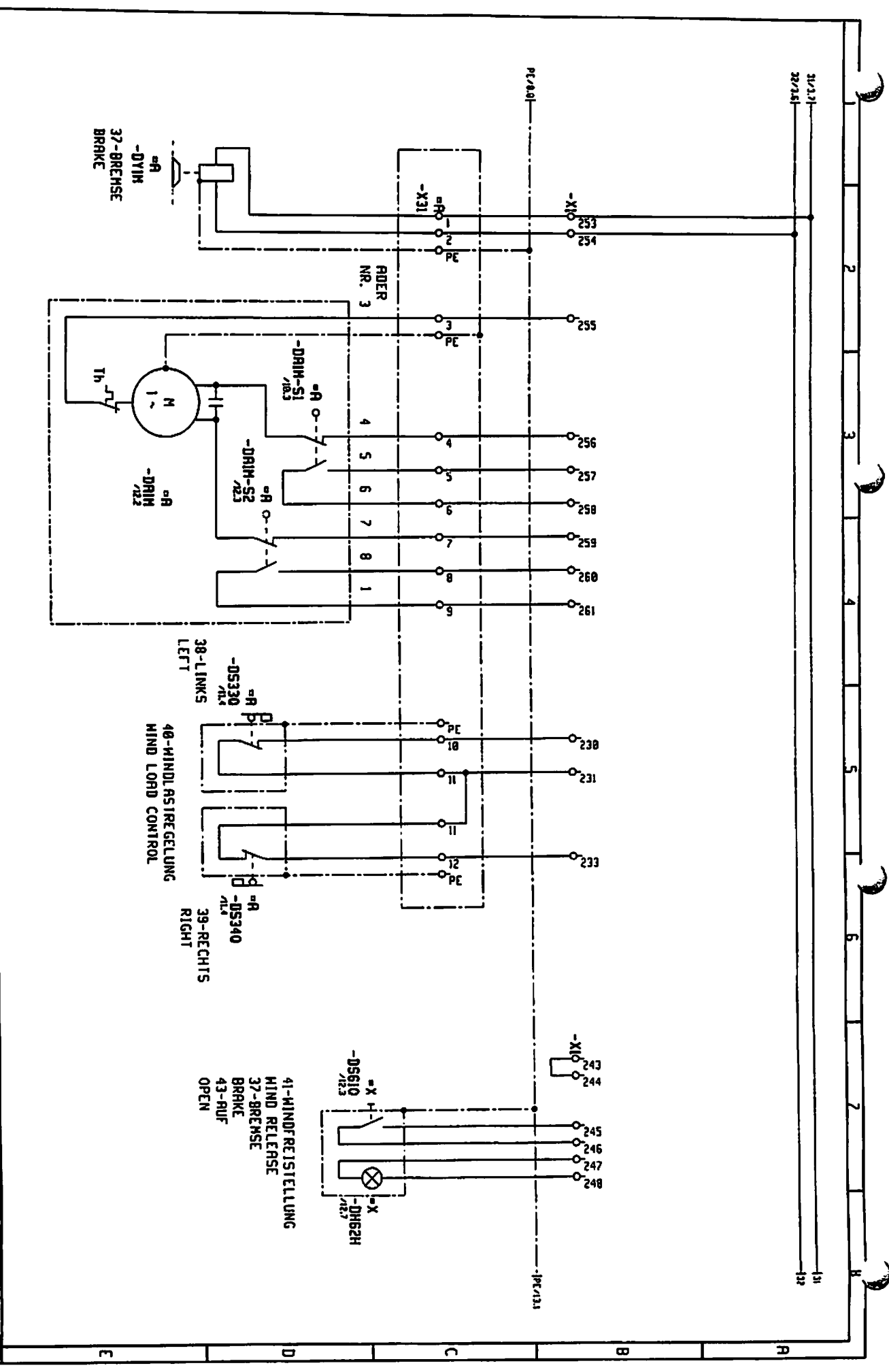

3	Gen.	09.04.98	Modell	LIEBHERR-MERK	TYPE	80/112/140 EC-B/EC-H	SI
2	Berch.	09.02.98		BIEBERACH GmbH	Zusatz	4005-21761	3+
1	Forderung			Copyright ©			41880981

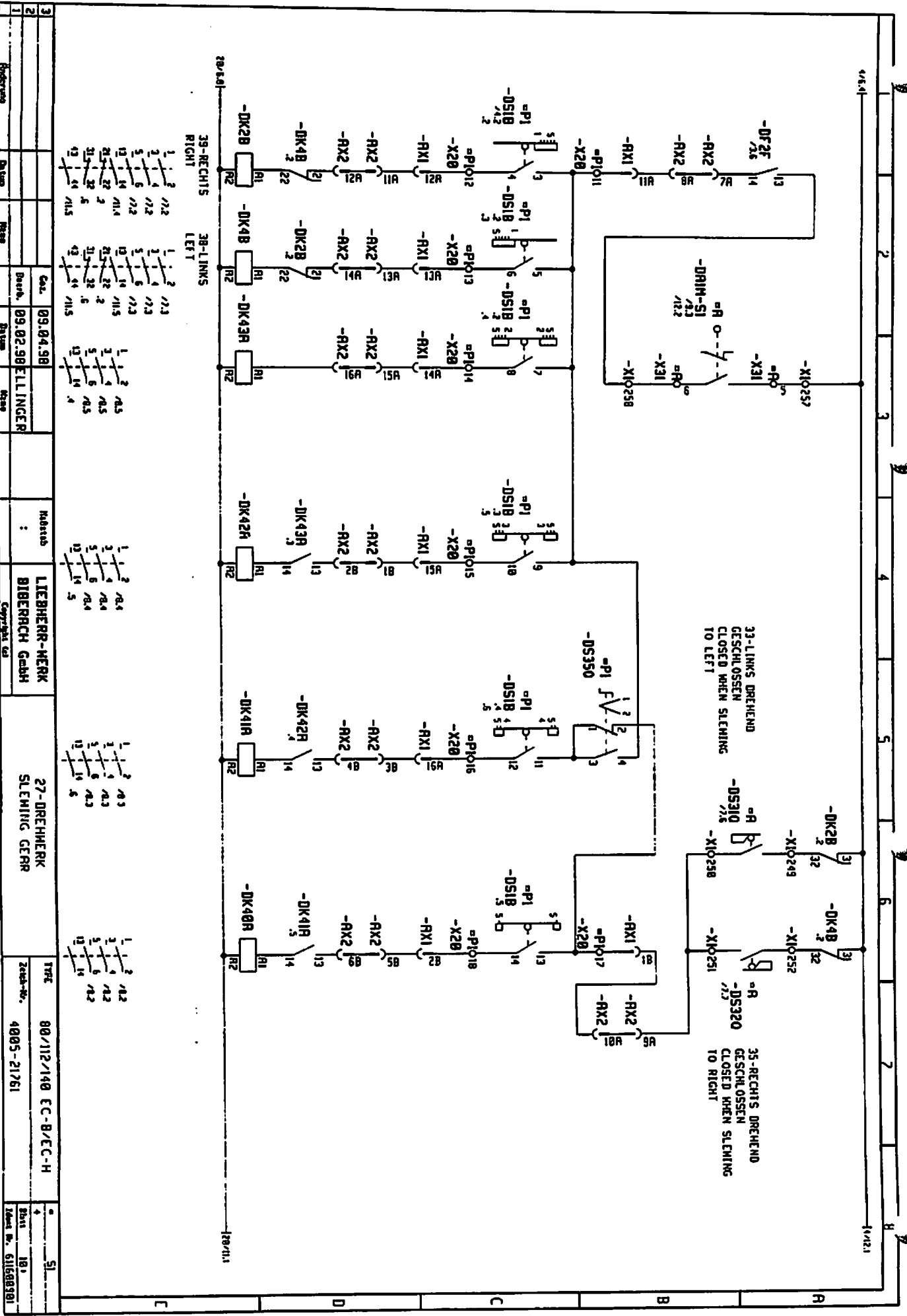

39-RECHTS RICHT	38-LINKS LEFT
1 1 2	1 1 2
2 1 4	2 1 4
3 1 5	3 1 5
4 1 6	4 1 6
5 1 7	5 1 7
6 1 8	6 1 8
7 1 9	7 1 9
8 1 10	8 1 10
9 1 11	9 1 11
10 1 12	10 1 12
11 1 13	11 1 13
12 1 14	12 1 14
13 1 15	13 1 15

Ca.	Da.	Di.	Di.
09.04.98	09.02.98	ELLINGER	

Ma.	Co.
LIEBHERR-MERK	BIBERACH GmbH

Ma.	Co.
27-DREHMERK	SLEWING GERÄT

TRF	Zeich.-Nr.
80/112/140 EC-B/EC-H	4005-21261

Blatt	Blatt-Nr.
101	51

Ma.	Co.
51	101

Ma.	Co.
51	101

Ma.	Co.
51	101

Ma.	Co.
51	101

Ma.	Co.
51	101

Ma.	Co.
51	101



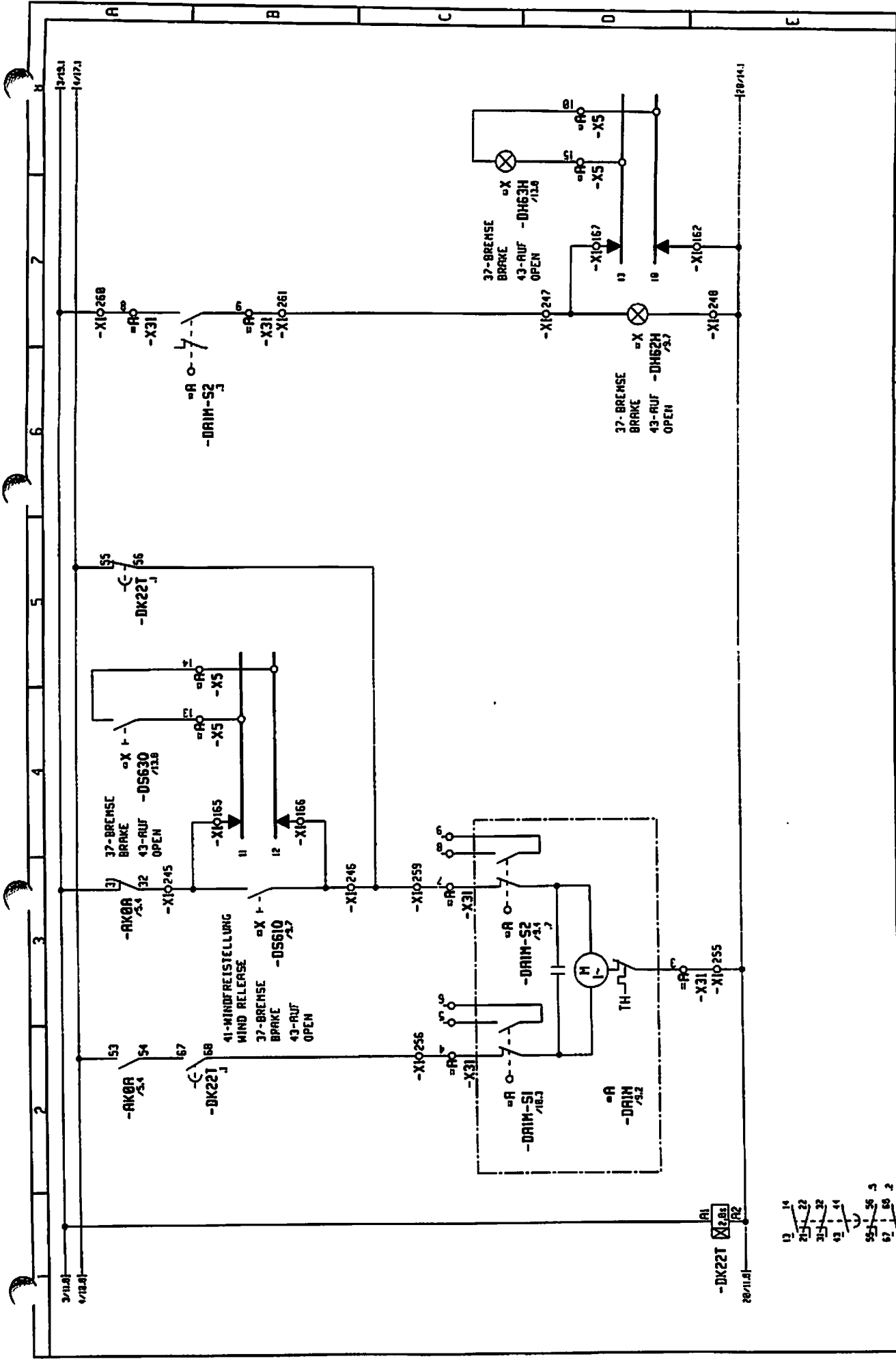

3	Ger.	09.04.98	Reisub	LIEBHERR-HERK BIBERACH GmbH Copyright for	27-DREHWERK SLEHING GEAR	TYPE 80/112/140 EC-B/EC-H	n	S1	
2	Barb.	09.02.98	ELLINGER						
1	Barb.	08.02.98	ELLINGER	Zusch.-Nr.	1005-21761	Reisub-Nr.	121	Reisub-Nr.	61160991

- 13 14
- 21 22
- 31 32
- 41 44
- 55 56 5
- 62 60 2

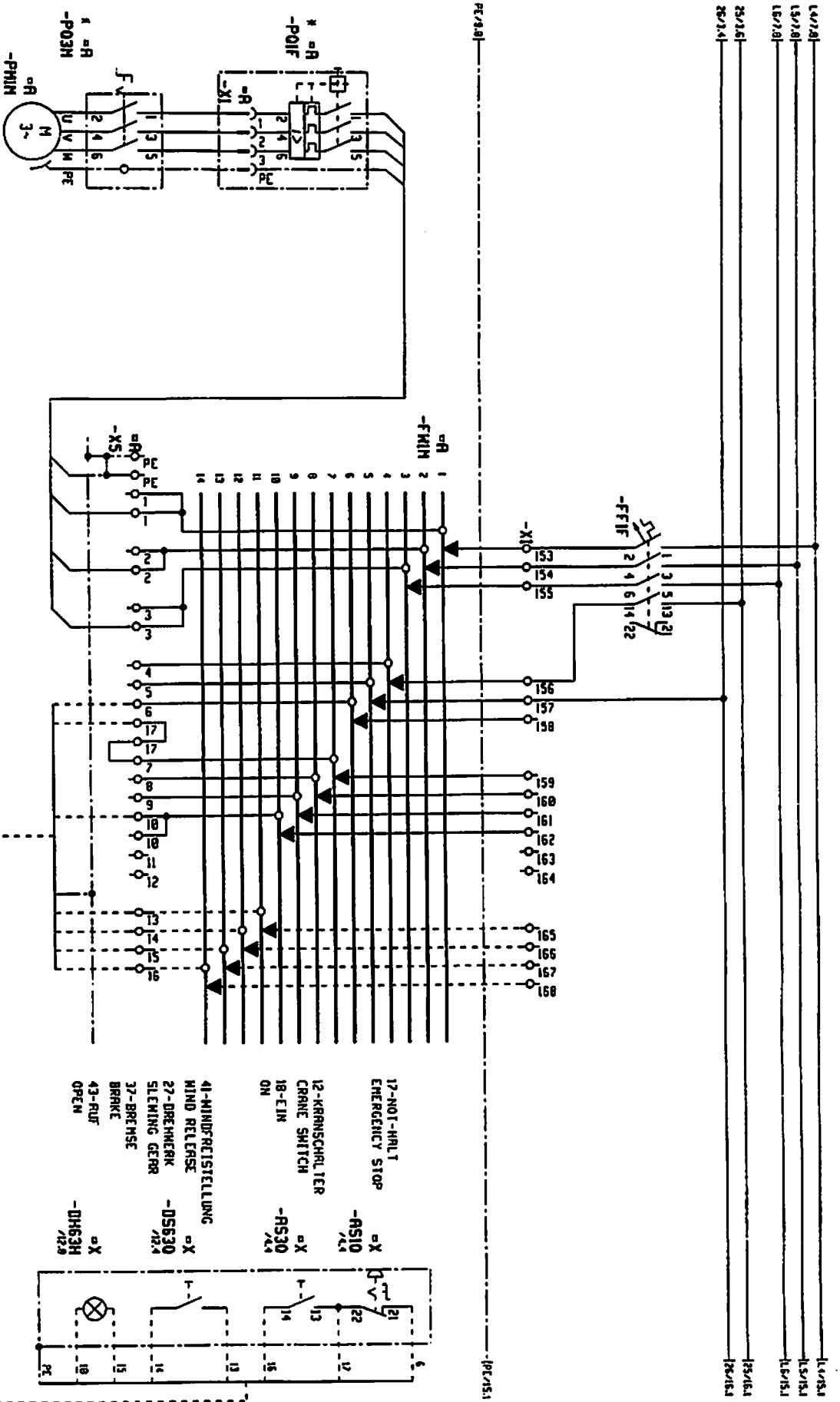

44-HYDRAULIK MOTOR  
HYDRAULIC MOTOR

				Anzahl		LIEBHERR-MERK		28-FÄHRMERK		TYPE		
3	2	1	1			BIEBERACH GmbH		TRIVELL ING GER		80/112/140 EC-B/C-H		SI
				:		Copyright 1973				Zusch-nr.		Datt 13
										4005-21761		Hand Nr. 61809801
Herstellung				Datum		Date		Date				
Herstellung				Datum		Date		Date				
				Ger.		03.04.98						
				Gerh.		03.02.98						

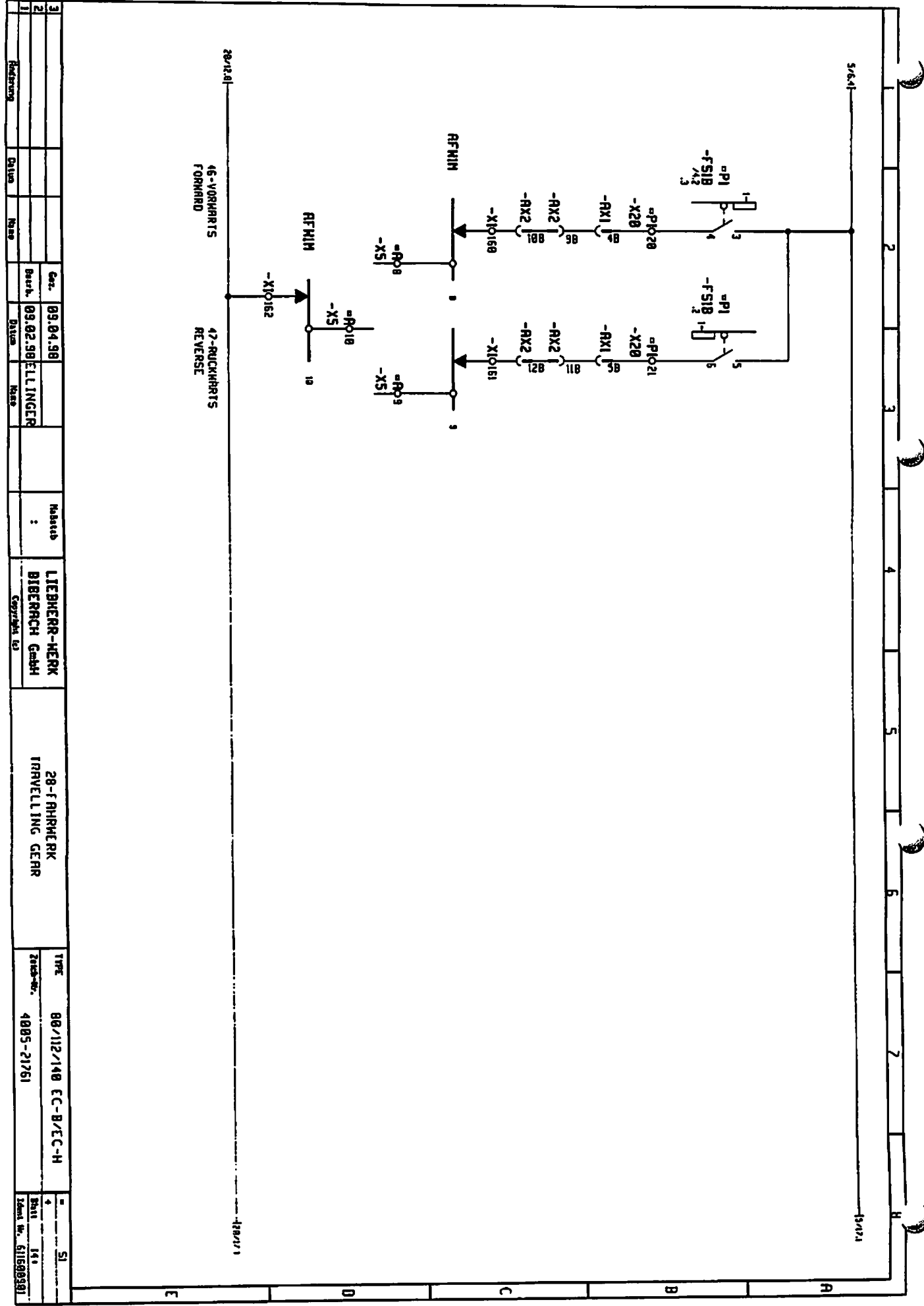

3	Bestellung	Datum	Name	Grz.	09.04.98	Kassette	LIEBHERR-MERK BIBERACH GmbH 28-FÄHRWERK IRRVELLING GEAR		TYPE	80/112/140 EC-B/E/C-H		SI		
2				Beauf.	09.02.98	FELLINGER			Zeich.-nr.	4005-21761	-	140	140	
1						Copyright ©				Ident. Nr.	611509381			

3				09.04.98		Modul	LIEBHERR-MERK	29-KATZFRÄHMER		1	SI
2				09.02.98	ELLINGER		BIBERACH GmbH	TROLEY TRAVEL GER			
1											

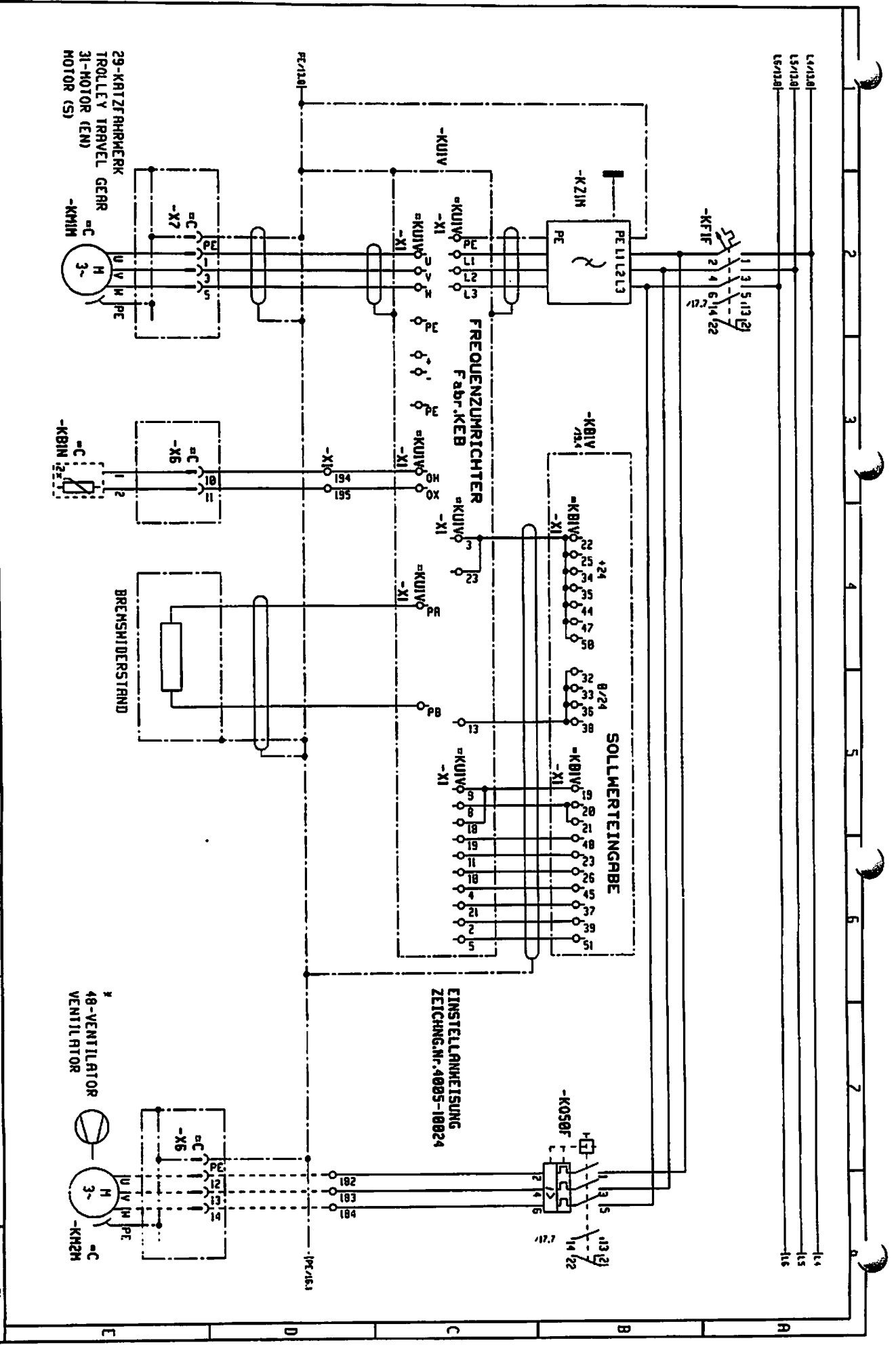

2 3 4 5 6 7 8 9

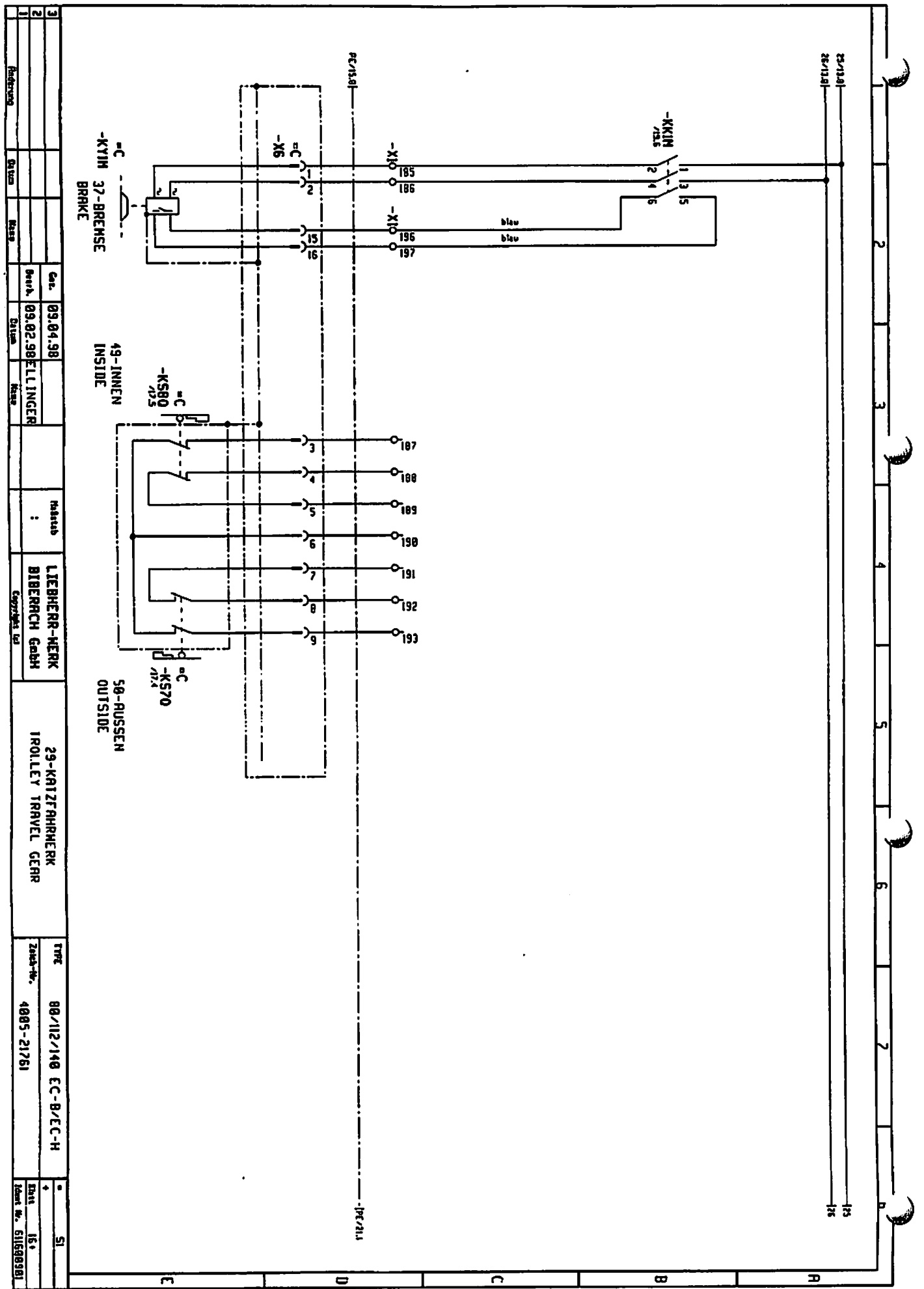

3	Car.	03.04.98	Hersteller	LIEBHERR-MERK	Trakt	88/112/148 EC-B/E/C-H	SI
2	Bau-Nr.	03.02.98		BIBERACH GmbH	Zusatz-Nr.	4085-21761	15+
1	Fahrer-Nr.						Ident. Nr. 615989361
	Ort						
	Baujahr						







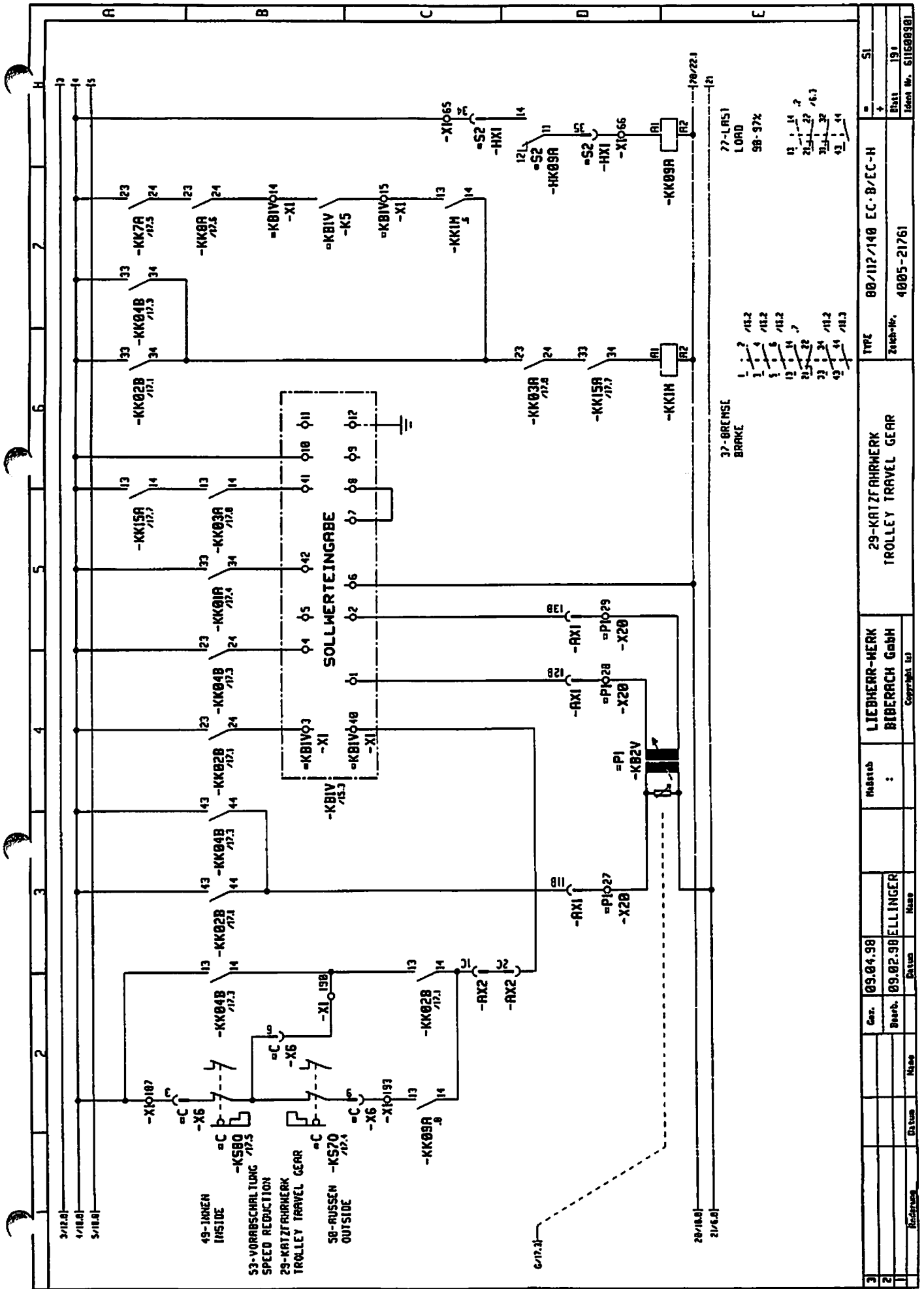

3		09.04.98	Gen.	Liebherr-Merk		29-KATZFÄHRWERK		TYPE		SI
2		09.02.98	Bearb.	BIBERACH GmbH		TROLLEY TRAVEL GEAR		Zust.-Nr.		191
1								4005-21761		Ident. Nr. 611609391

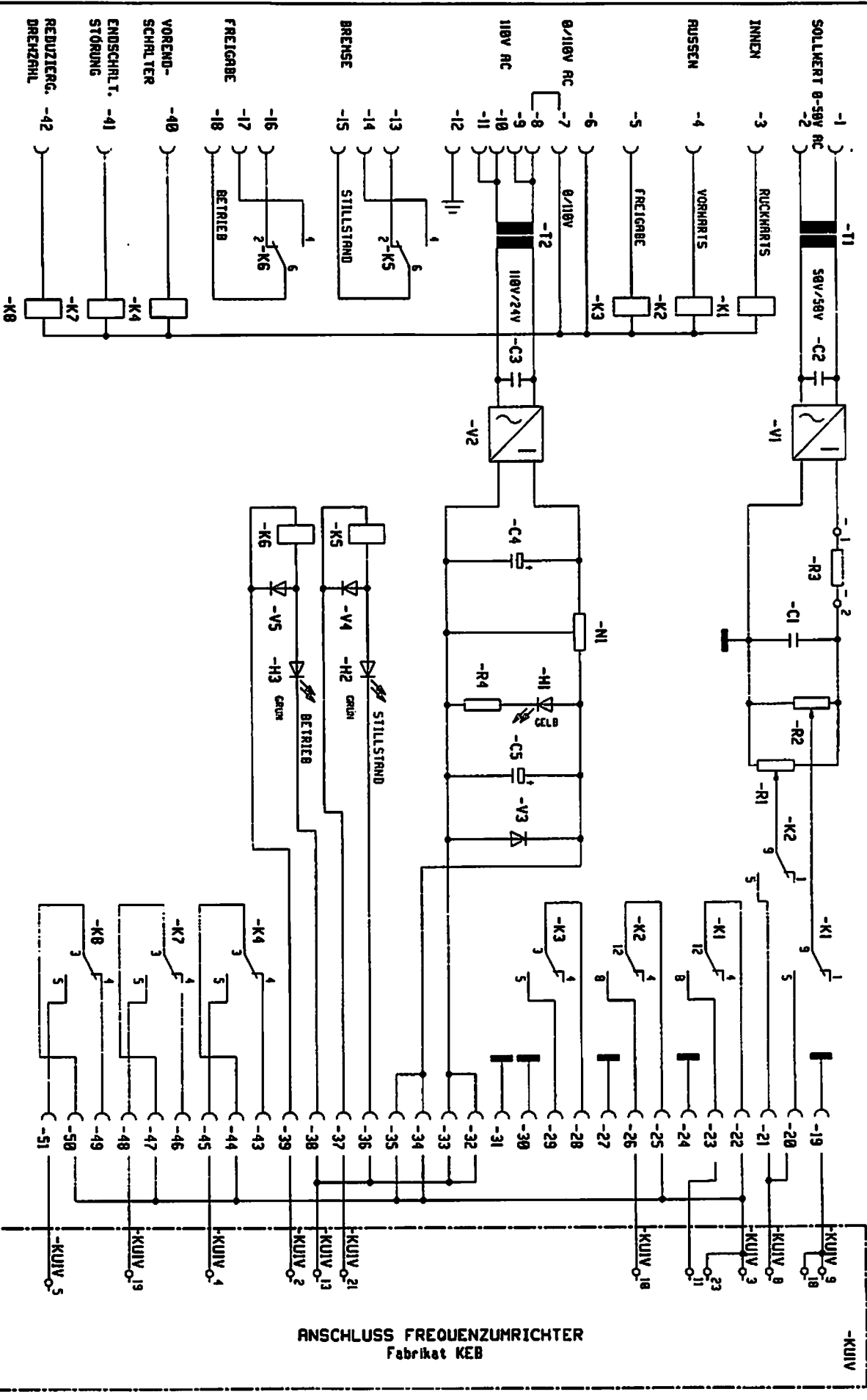

3		Gas.	09.04.98	Mitarbeiter		LIEBHERR-MERK		SOLLMEREINGANG FREQUENZUMR.		TPK	80/112/140 EC-B/E/C-H	SI
2		Fabr.-Nr.	09.02.98	Name		BIBERROCH GmbH		Zeich.-Nr.		1005-21761	Datum	
1		Revisions-Nr.		Name		Copyright ©		Fabrik-Nr.		51609381		





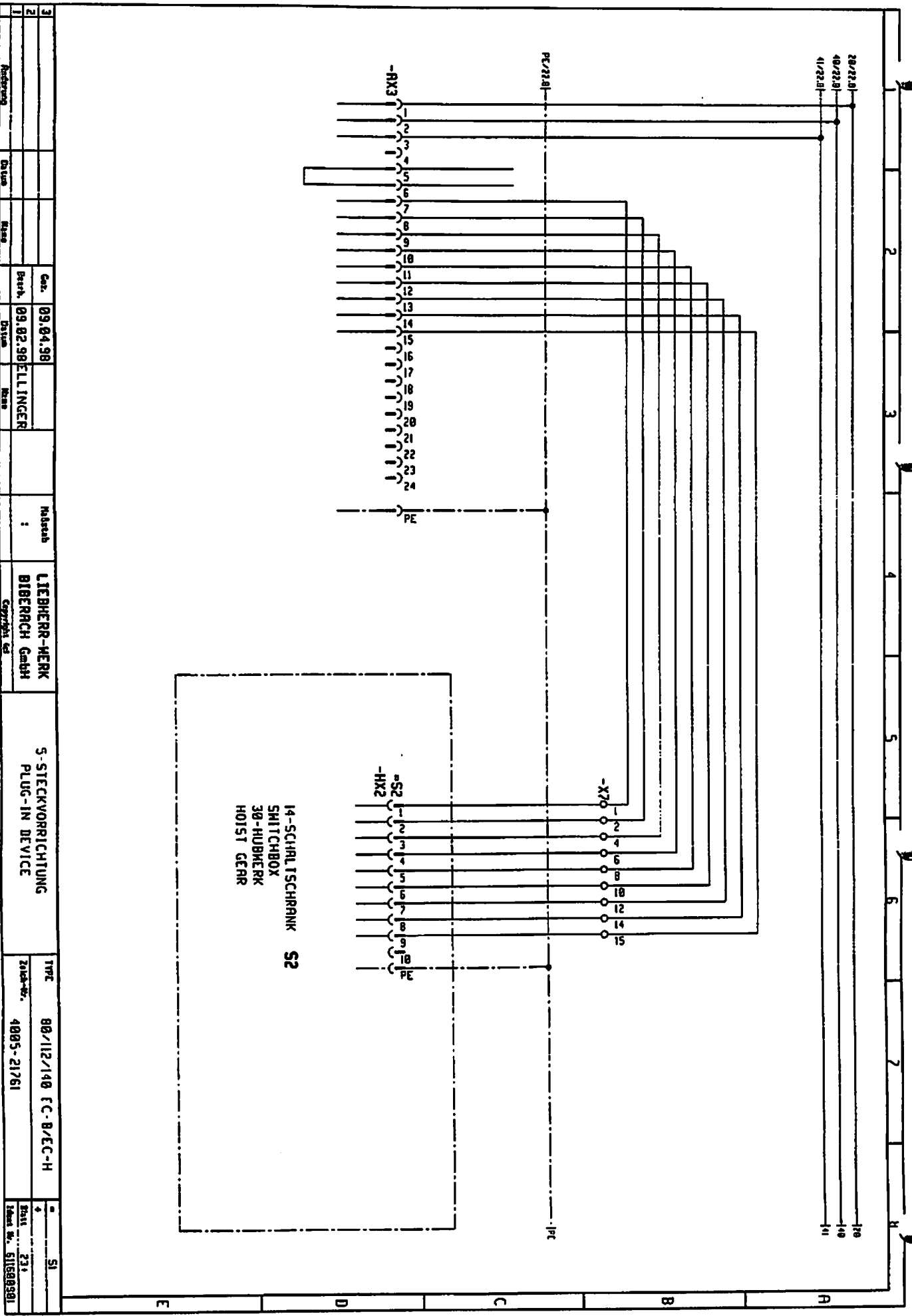

3					Car.	09.04.98			Rebstat	:	LIEBHERR-MERK	5-STECKVORRICHTUNG PLUG-IN DEVICE	TYPE	80/112/140 FC-B/E/C-H	SI
2				Part.	09.02.98	PELLINGER				BIBERACH GmbH	Zust.-Nr.		4005-21761	↓	231
1	Revisions	Datum	Revis		Datum	Revis				Copyright ©				↑	Ident. Nr. 51580991

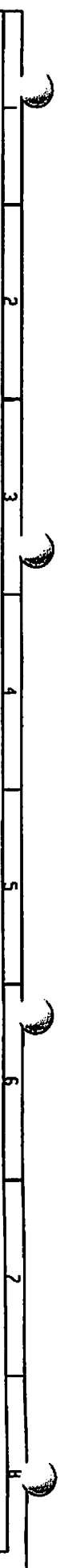

**S1RX1**

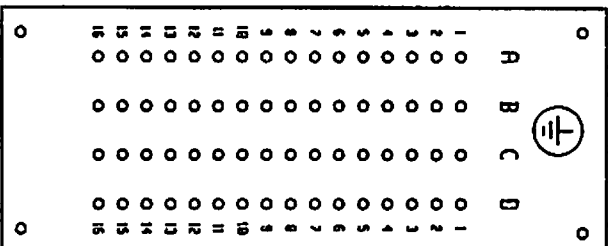
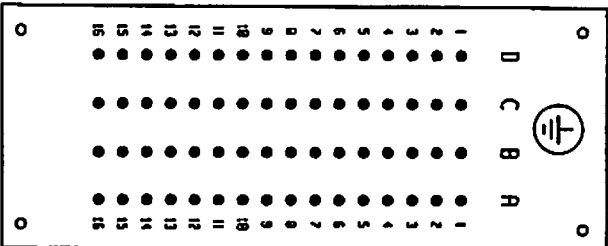

STI  
S1-ANSICHT ANSCHLUSSEITE  
VIEW FROM CABLE SIDE

bu

**S1RX2**

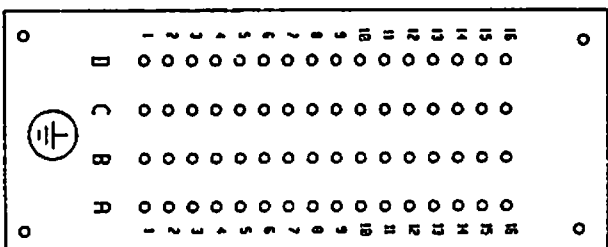
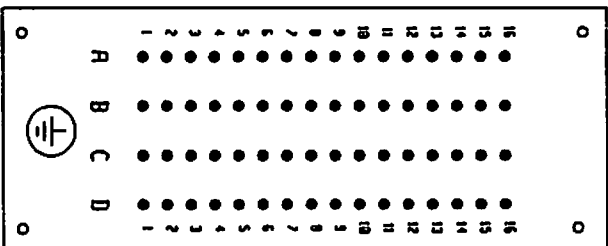

STI  
S1-ANSICHT ANSCHLUSSEITE  
VIEW FROM CABLE SIDE

bu

**S1RX3**

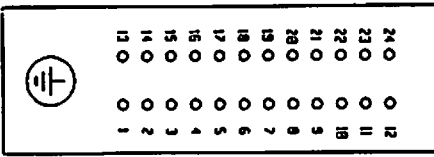
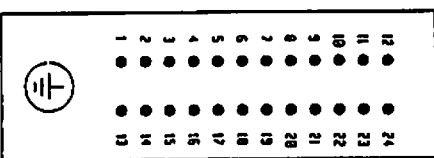

STI  
S1-ANSICHT ANSCHLUSSEITE  
VIEW FROM CABLE SIDE

bu

3				Gen.	09.04.98		Material	LIEBHERR-MERK	5-STECKVORRICHTUNG PLUG-IN DEVICE	TYPE	80/112/140 EC-B/E/C-H	SI
2				Bauh.	09.02.98	ELLINGER	:	BIBERACH GmbH		Zeich.-Nr.	4005-21761	241
1	Freiburg	Düren	Ries	Datum		Plan	Copyright by					Ident. Nr.





3				Gez.	09.04.98		Modell	LIEBHERR-MERK	122-BUSFÜHRUNG	TYPE	88/112/140 EG B/E/C-H	
2				Bearb.	09.02.98	FILLINGEP		BIBERACH GmbH	FOPM	Zeich.-Nr.	4005-21761	
1				Datum				Copyright (c)	EMS-IBB	Blatt	26	
				Neuz						Ident. Nr.	61E009301	
												SI

