

9-SCHRANKHEIZUNG (EN)
 SWITCH BOX HEATING (S)
 CHAUFFAGE (S) ARM. ELECTR.

136-EINGESTELLT AUF
 ADJUSTED TO
 RÉGLÉ À
 90A (37KW)
 110A (45KW)

254-SCHUKO-STECKDOSE
 EARTHED SOCKET
 P DE COURANT A CONTACT DE PROT



* = 10-NICHT SERIENMAESSIG
 NOT STANDARD
 PAS STANDARD

269-SCHIRM ÜBER EINBAUSTECKER
 AM SCHALTSCHRANK
 SHIELD CONNECTED WITH CABINET
 BLIND FICHE ENCAST
 A L'ARM ELECTR

3			Gez.	27.08.09	Ott		Maßstab	LIEBHERR-WERK	11-EINSPEISUNG SUPPLY ALIMENTATION	TYPE	EC-H/EC-B 37/45KW, FU	=	S2	
2			Bearb.	27.11.98	Ernle	:		BIBERACH GmbH		Zeich-Nr.	4005-21710	+		
1	Änderung	Datum	Name	Datum	Name		Copyright (c)					Blatt	1+	Ident Nr.

A
B
C
D
E

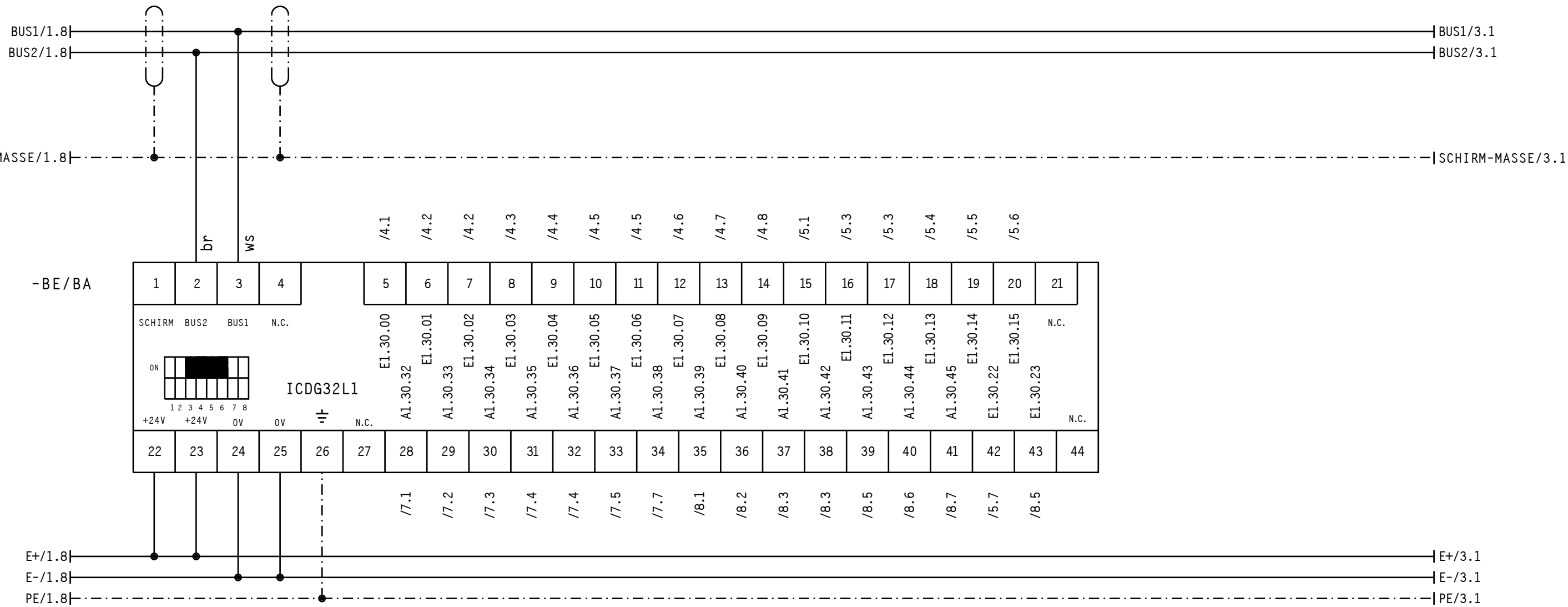

3			Gez.	27.08.09	Ernle		Maßstab	LIEBHERR-WERK	395-BINÄRE EIN-/AUSGÄNGE SPS ENTREES-/SORTIES BINAIRES API	TYPE	EC-H/EC-B 37/45KW,FU	=	S2	
2			Bearb.	13.05.98	Ernle	:		BIBERACH GmbH		Zeich-Nr.	4005-21710	+		
1	Änderung	Datum	Name	Datum	Name		Copyright (c)					Blatt	2+	Ident Nr.

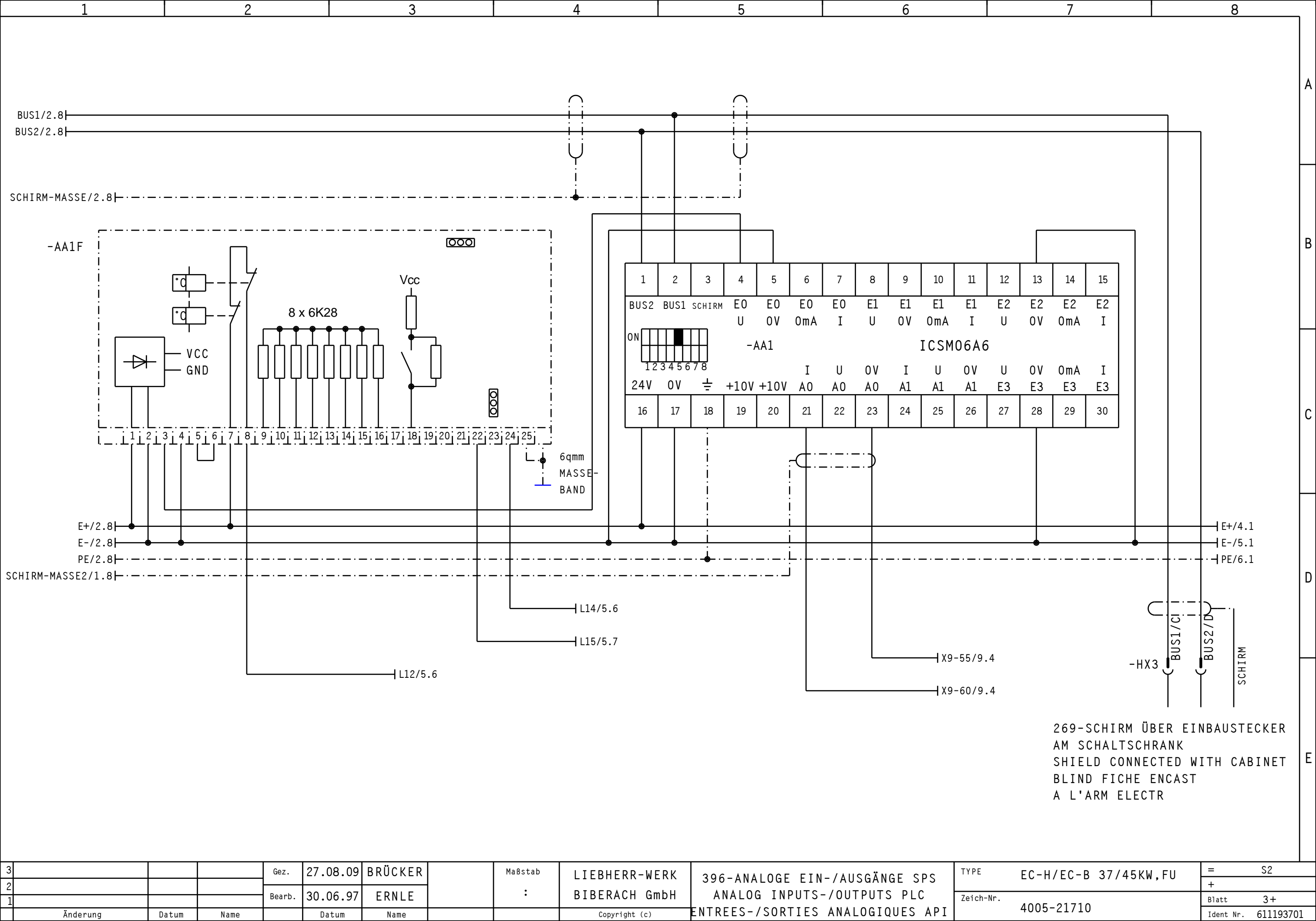

269-SCHIRM ÜBER EINBAUSTECKER
 AM SCHALTSCHRANK
 SHIELD CONNECTED WITH CABINET
 BLIND FICHE ENCAST
 A L'ARM ELECTR

3			Gez.	27.08.09	BRÜCKER		Maßstab	LIEBHERR-WERK	396-ANALOGUE EIN-/AUSGÄNGE SPS	TYPE	EC-H/EC-B 37/45KW,FU	=	S2
2			Bearb.	30.06.97	ERNLE		:	BIBERACH GmbH	ANALOG INPUTS-/OUTPUTS PLC	Zeich-Nr.	4005-21710	+	
1	Änderung	Datum	Name	Datum	Name			Copyright (c)	ENTREES-/SORTIES ANALOGIQUES API			Blatt	3+
												Ident Nr.	611193701

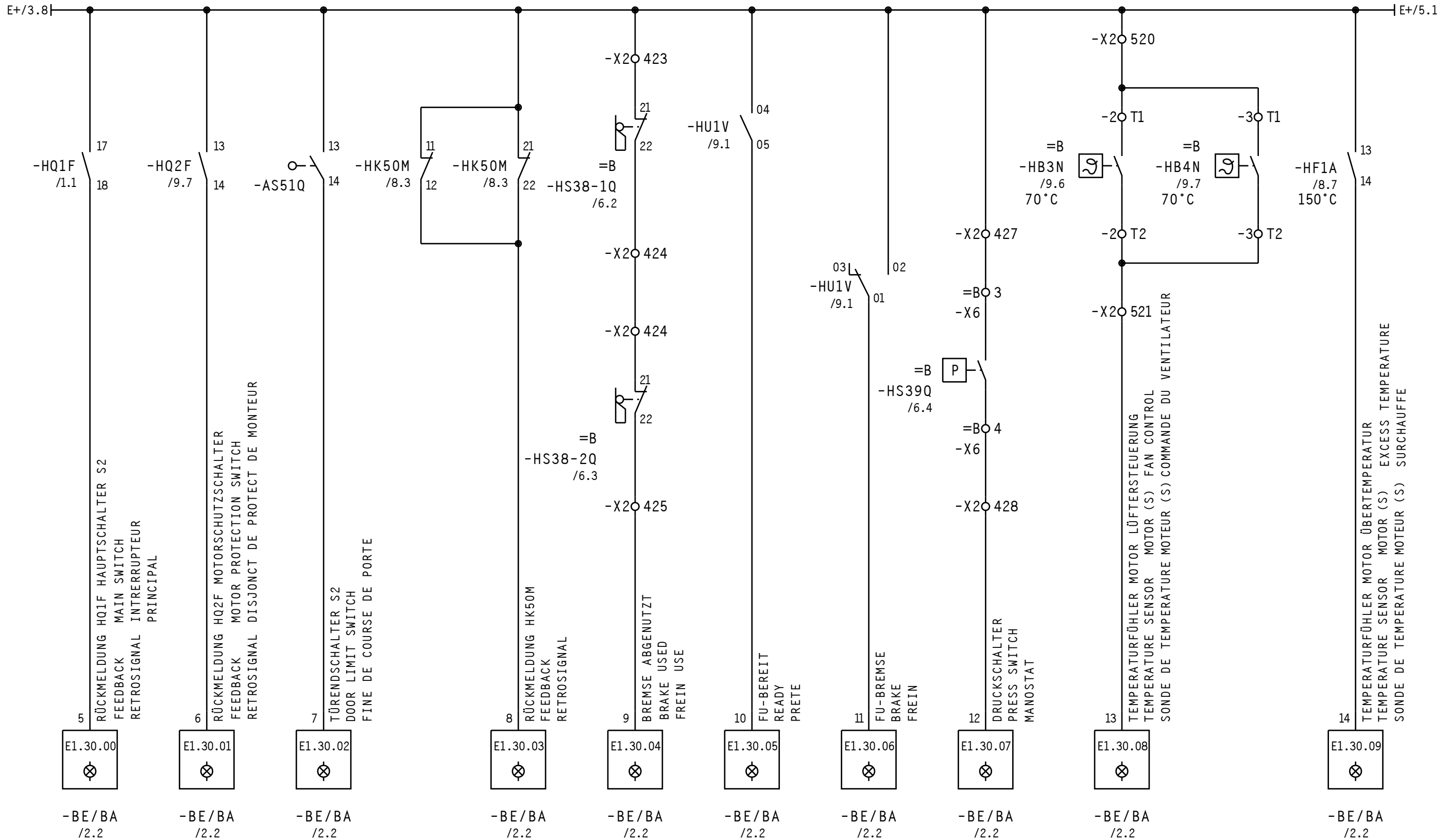

3			Gez.	27.08.09	BRÜCKER	Maßstab	LIEBHERR-WERK	384-BINÄRE EINGÄNGE SPS BINARY INPUTS PLC ENTREES BINAIRES API	TYPE	EC-H/EC-B 37/45KW,FU	=	S2	
2			Bearb.	30.06.97	ERNLE	:	BIBERACH GmbH		Zeich-Nr.	4005-21710	+		
1	Änderung	Datum	Name	Datum	Name		Copyright (c)				Blatt	4+	Ident Nr.

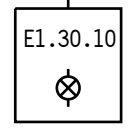
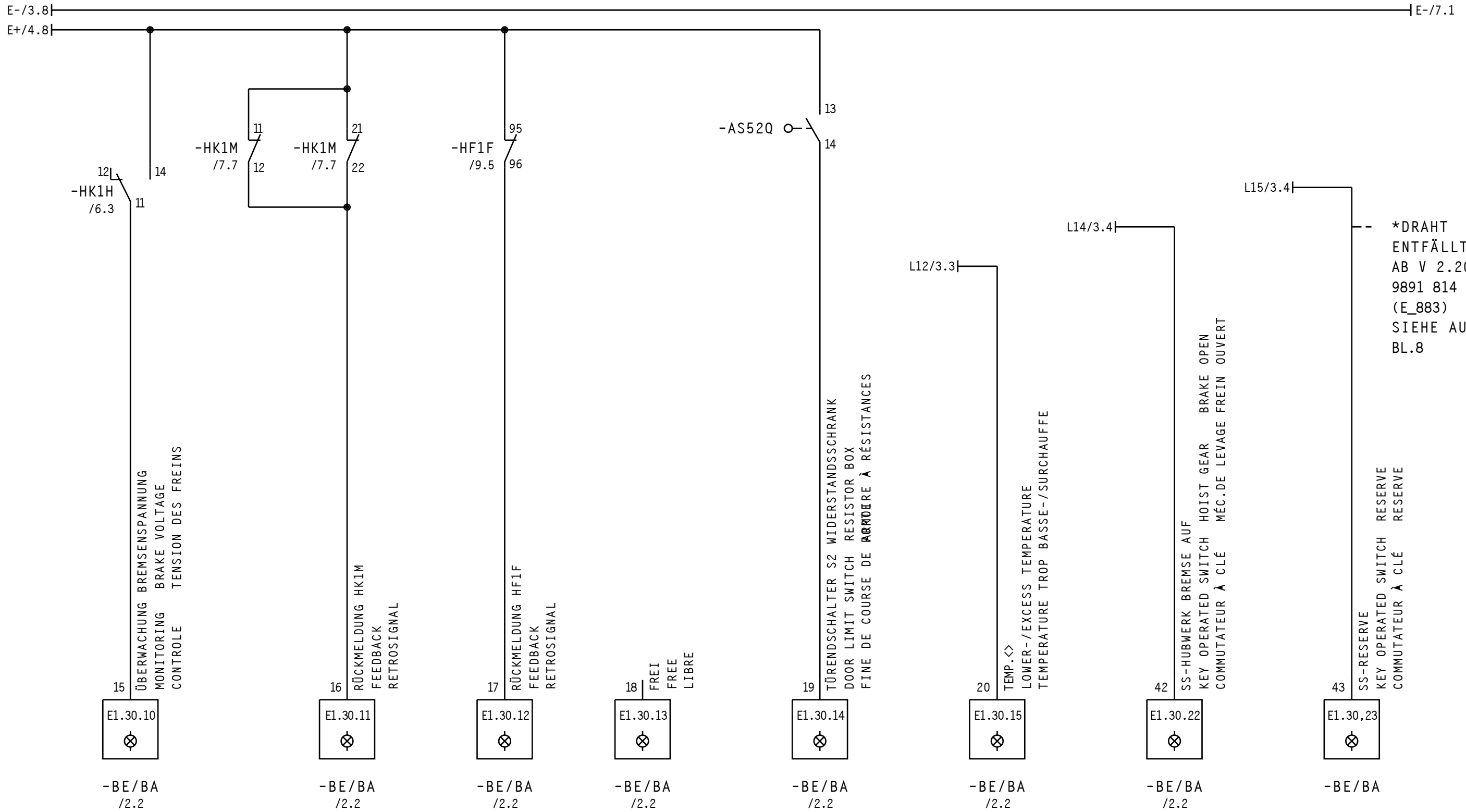

-BE/BA /2.2

15
 ÜBERWACHUNG BREMSENSPANNUNG
 MONITORING BRAKE VOLTAGE
 CONTROLE TENSION DES FREINS

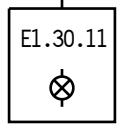

-BE/BA /2.2

16
 RÜCKMELDUNG HK1M
 FEEDBACK
 RETRO SIGNAL

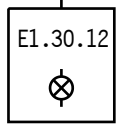

-BE/BA /2.2

17
 RÜCKMELDUNG HF1F
 FEEDBACK
 RETRO SIGNAL

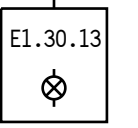

-BE/BA /2.2

18
 FREI
 FREE
 LIBRE

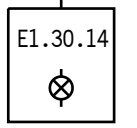

-BE/BA /2.2

19
 TÜRENDSCHALTER S2 WIDERSTANDSSCHRANK
 DOOR LIMIT SWITCH RESISTOR BOX
 FINE DE COURSE DE ~~ACRORE~~ À RÉSISTANCES

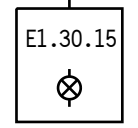

-BE/BA /2.2

20
 TEMP.<>
 LOWER-/EXCESS TEMPERATURE
 TEMPERATURE TROP BASSE-/SURCHAUFFE

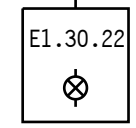

-BE/BA /2.2

42
 SS-HUBWERK BREMSE AUF
 KEY OPERATED SWITCH HOIST GEAR BRAKE OPEN
 COMMUTATEUR À CLÉ MÉC.DE LEVAGE FREIN OUVERT

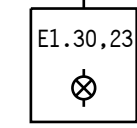

-BE/BA

43
 SS-RESERVE
 KEY OPERATED SWITCH RESERVE
 COMMUTATEUR À CLÉ RESERVE

*DRAHT
 ENTFÄLLT
 AB V 2.20
 9891 814 01
 (E_883)
 SIEHE AUCH
 BL.8

3			Gez.	27.08.09	ERNLE		Maßstab	LIEBHERR-WERK	384-BINÄRE EINGÄNGE SPS BINARY INPUTS PLC ENTREES BINAIRES API	TYPE	EC-H/EC-B 37/45KW,FU	=	S2	
2			Bearb.	31.07.00	ERNLE	:	BIBERACH GmbH	Zeich-Nr.		4005-21710	+		Blatt	5+
1	Änderung	Datum	Name	Datum	Name		Copyright (c)						Ident Nr.	611193701

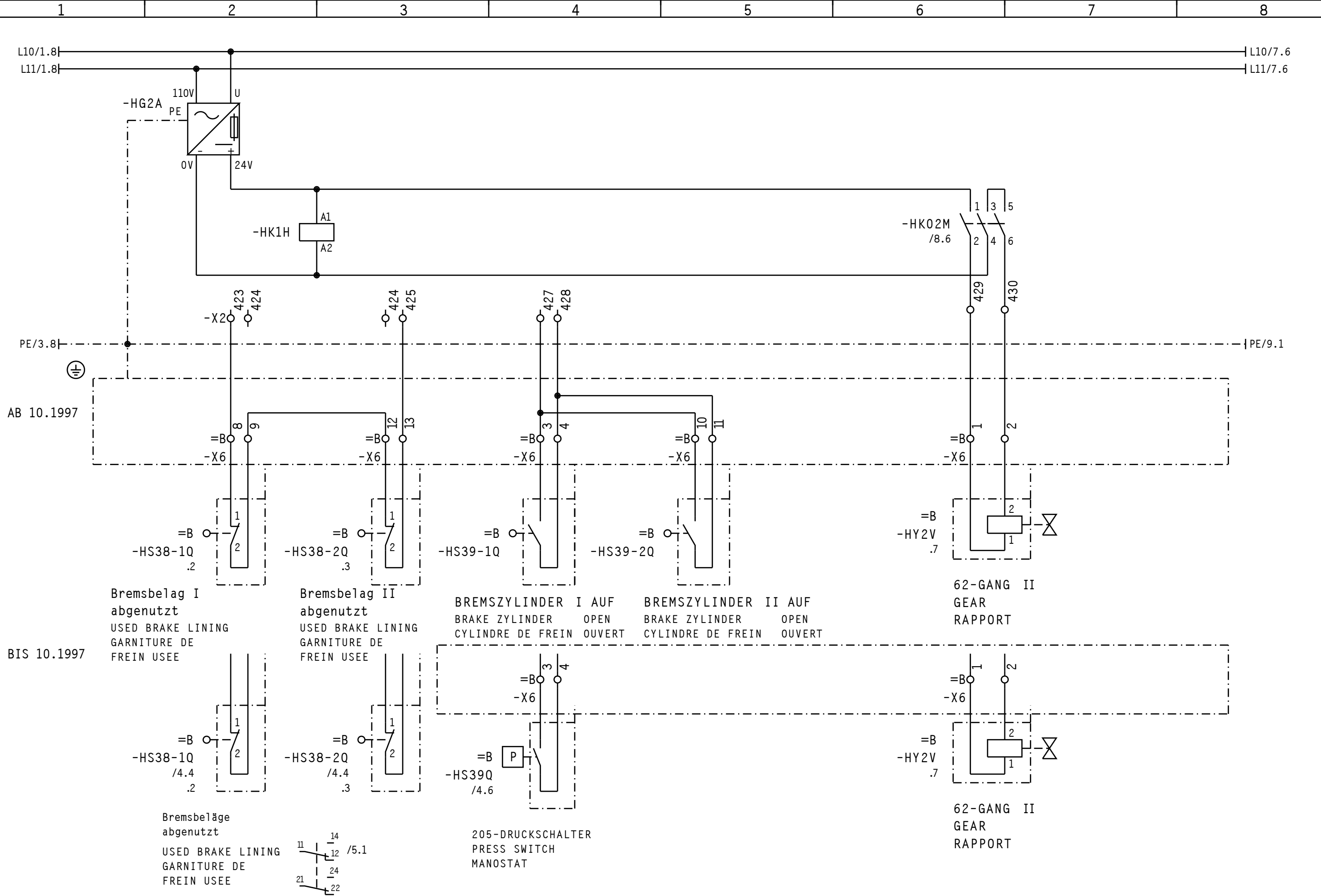

3			Gez.	27.08.09	ERNLE		Maßstab	LIEBHERR-WERK	30-HUBWERK HOIST GEAR MÉC. DE LEVAGE	TYPE	EC-H/EC-B 37/45KW, FU	=	S2	
2			Bearb.	27.10.97	ERNLE	:	BIBERACH GmbH	Zeich-Nr.		4005-21710	+		Blatt	6+
1	Änderung	Datum	Name	Datum	Name		Copyright (c)						Ident Nr.	611193701

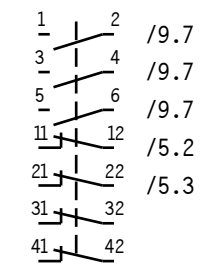
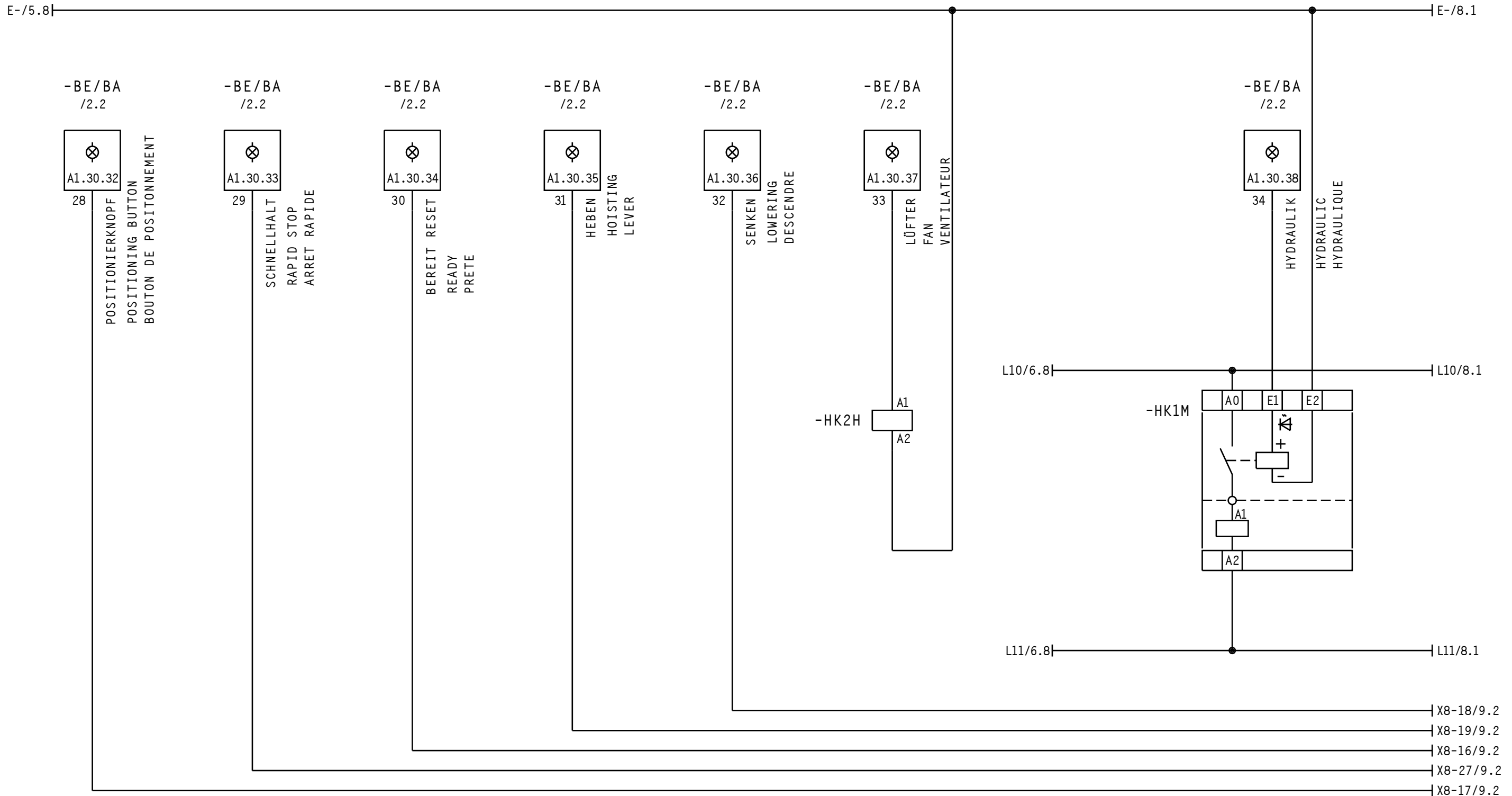

1/13. 2/14 /1.6

3			Gez.	27.08.09	BRÜCKER		Maßstab	LIEBHERR-WERK	387-BINÄRE AUSGÄNGE SPS	TYPE	EC-H/EC-B 37/45KW,FU	=	S2
2			Bearb.	30.06.97	ERNLE		:	BIBERACH GmbH	BINARY OUTPUTS PLC	Zeich-Nr.	4005-21710	+	
1	Änderung	Datum	Name	Datum	Name			Copyright (c)	SORTIES BINAIRES API			Blatt	7+
												Ident Nr.	611193701

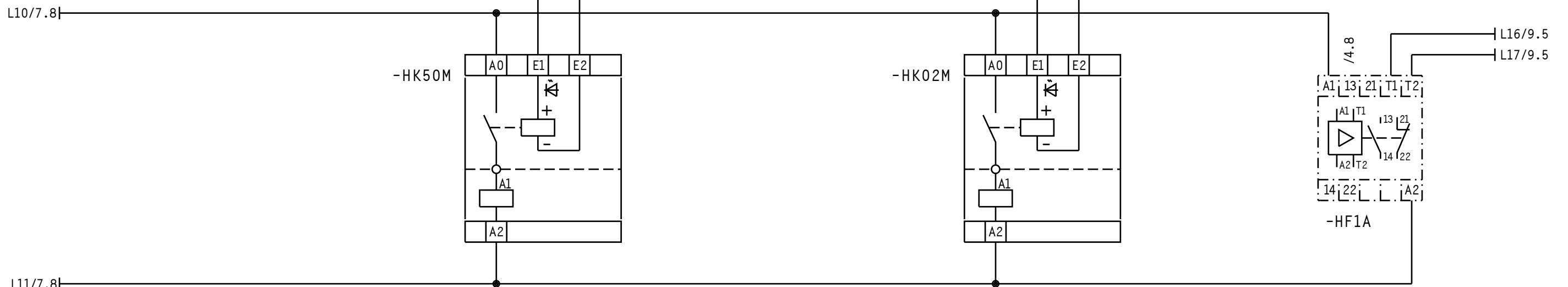
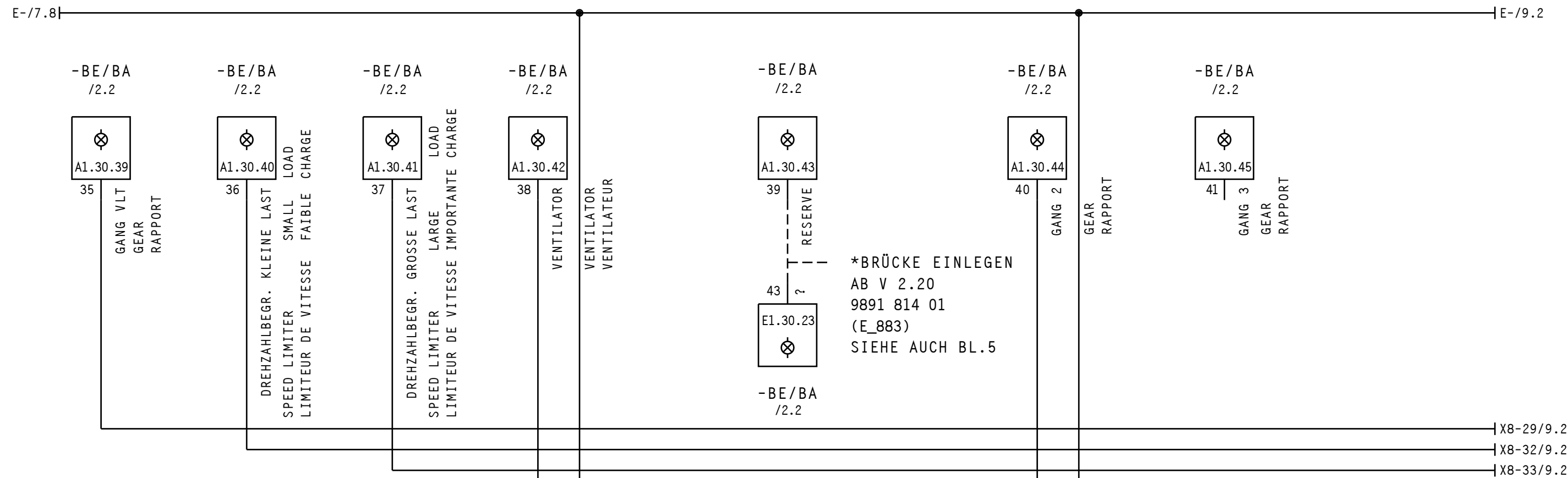

37-BREMSE 1 62-GANG 2
 BRAKE 1 GEAR 2
 FREIN 1 RAPPORT 2

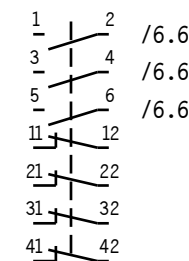
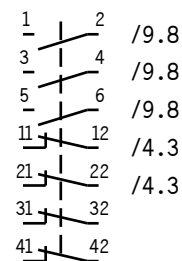

3			Gez.	27.08.09	ERNLE		Maßstab	LIEBHERR-WERK	387-BINÄRE AUSGÄNGE SPS BINARY OUTPUTS PLC SORTIES BINAIRES API	TYPE	EC-H/EC-B 37/45KW,FU	=	S2
2			Bearb.	31.07.00	ERNLE	:		BIBERACH GmbH		Zeich-Nr.	4005-21710	+	
1	Änderung	Datum	Name	Datum	Name		Copyright (c)					Blatt	8+

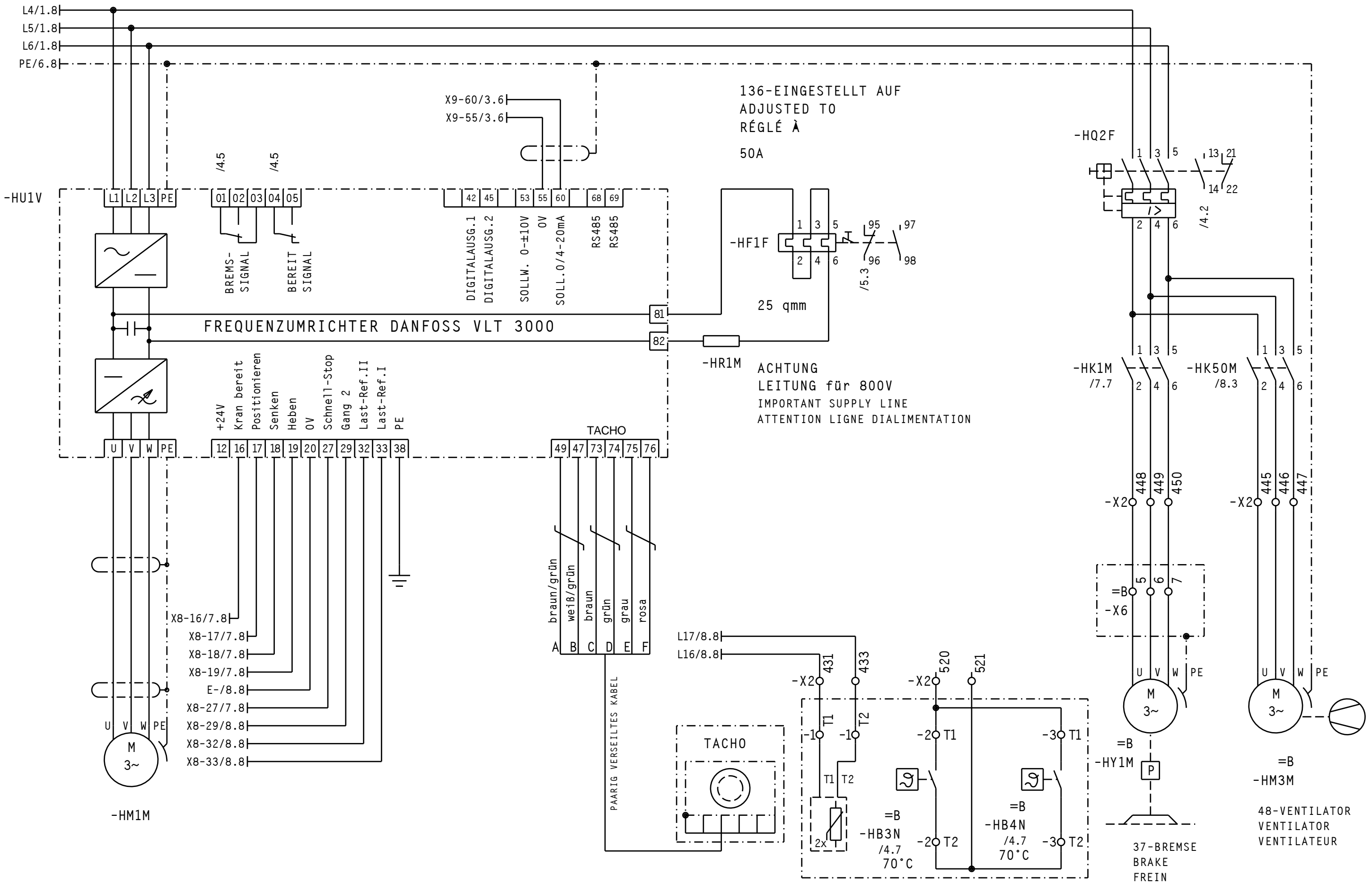

3			Gez.	27.08.09	Ott	Maßstab	LIEBHERR-WERK BIBERACH GmbH	TYPE	EC-H/EC-B 37/45KW, FU	=	S2
2			Bearb.	26.11.98	ERNLE	:		Zeich-Nr.	4005-21710	+	
1	963081	27.03.96	BRÜCKER				Copyright (c)			Blatt	9+
	Änderung	Datum	Name	Datum	Name				4005-21710	Ident Nr.	611193701

bu

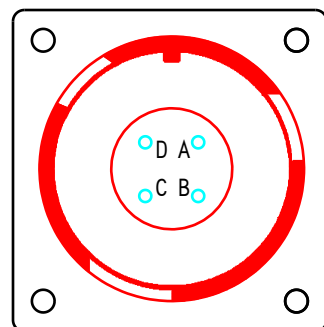
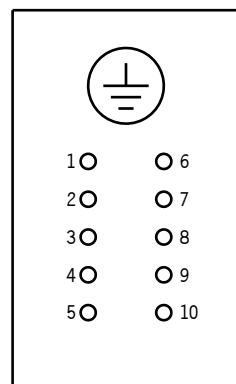

sti

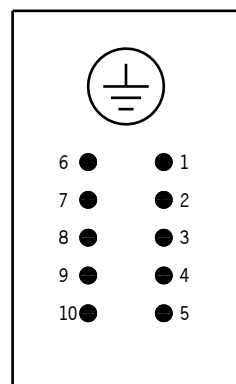

HX1

HX3

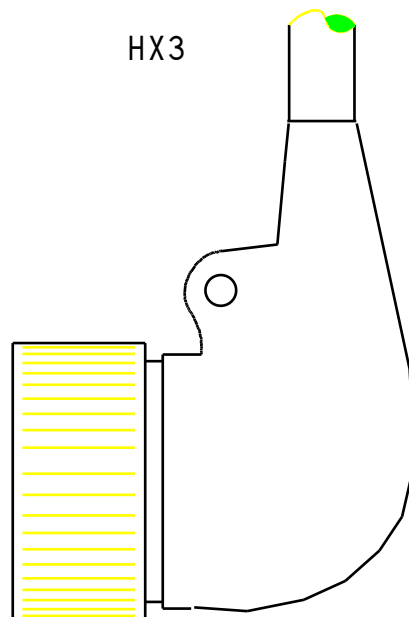

LEGENDE HX1

- 1
- 2 0/110V
- 3 110V DAUER
- 4
- 5
- 6
- 7 110V GESCHALTET
- 8
- 9
- 10

LEGENDE HX3

- A BUS 1 KOMMT
- B BUS 2 KOMMT
- C BUS 1 GEHT
- D BUS 2 GEHT

3			Gez.	27.08.09	BRÜCKER		Maßstab	LIEBHERR-WERK	398-STECKER	399-PLATTE	30-HUBWERK	TYPE	EC-H/EC-B 37/45KW, FU	=	S2
2			Bearb.	30.06.97	ERNLE		:	BIBERACH GmbH	PLUG	PLATE	HOIST GEAR	Zeich-Nr.	4005-21710	+	
1	Änderung	Datum	Name	Datum	Name			Copyright (c)	FICHE	PLAQUE	MÉC.DE LEVAGE			Blatt	10-
														Ident Nr.	611193701