

3	Ca.	26.12.93	Radstüb	LIEBHERR-MERK	TYPE	HC / HC-S	SI
2	Beib.	01.06.93	:	BIBERACH GmbH	Zeich.-Nr.	4085-21552	Blatt
1	Beib.			Copyright Ltd			1+
	Beib.						Ediert Nr.

11-EINSPEISUNG SUPPLY
 11-LICHTTRANSFORMATOR LIGHTING TRANSFORMER

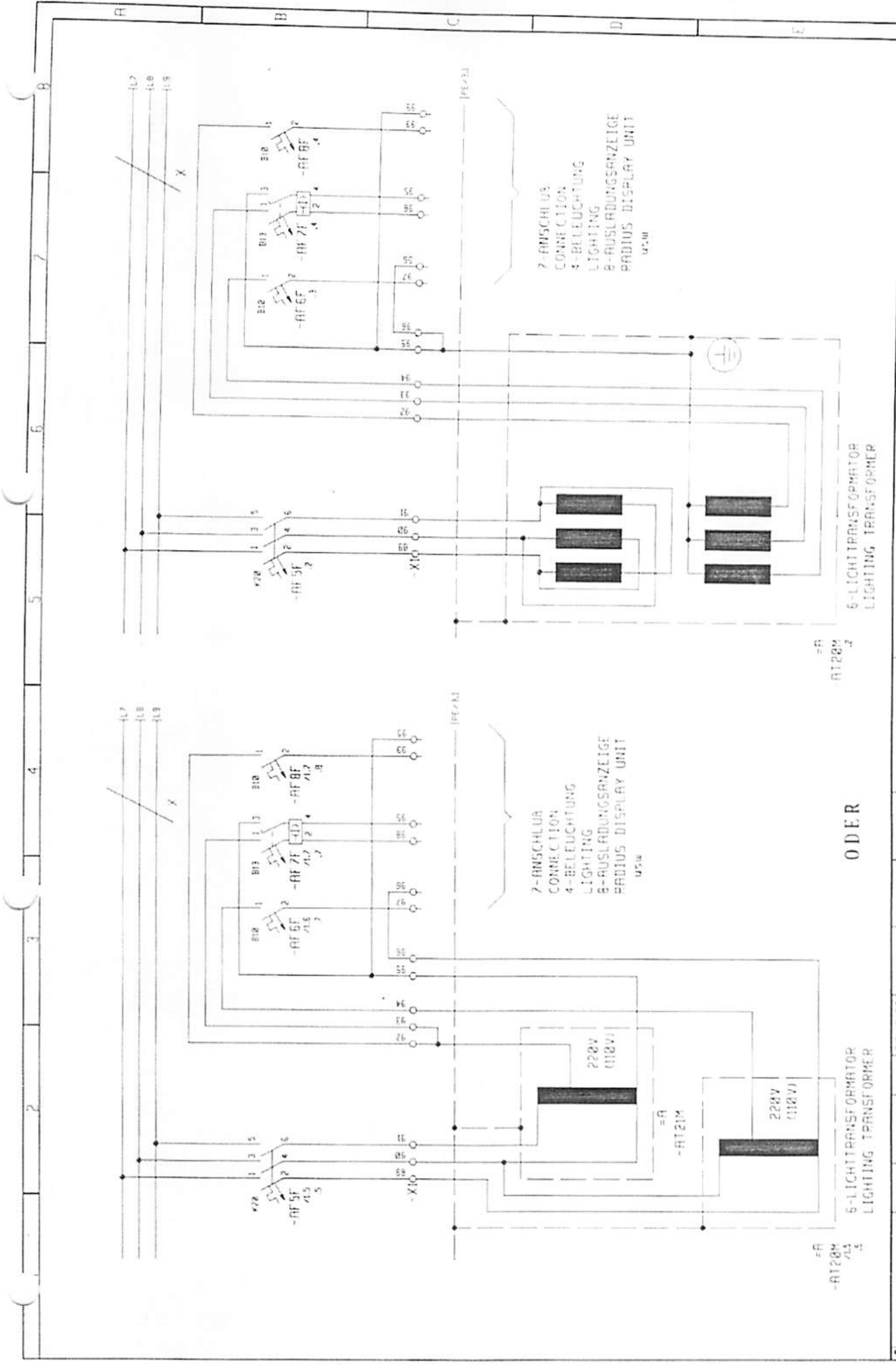

7-ANSCHLUS
CONNECTION
4-BELEUCHTUNG
LIGHTING
8-AUSLADUNGSANZEIGE
RADIO DISPLAY UNIT
usw.

7-ANSCHLUS
CONNECTION
4-BELEUCHTUNG
LIGHTING
8-AUSLADUNGSANZEIGE
RADIO DISPLAY UNIT
usw.

6-LICHTTRANSFORMATOR
LIGHTING TRANSFORMER

6-LICHTTRANSFORMATOR
LIGHTING TRANSFORMER

-AT20M

-AT21M

ODER

3	Gen.	28.12.93	Herstell.	LIEBHERR-WERK	TYPE	HC 7 HC-5	Blatt	51
2	Bearb.	01.05.93	Proj.	BIBERACH GmbH	Techn.-Nr.	4003-23552	Blatt	2-
1	Druckung			Copyright G. J.				

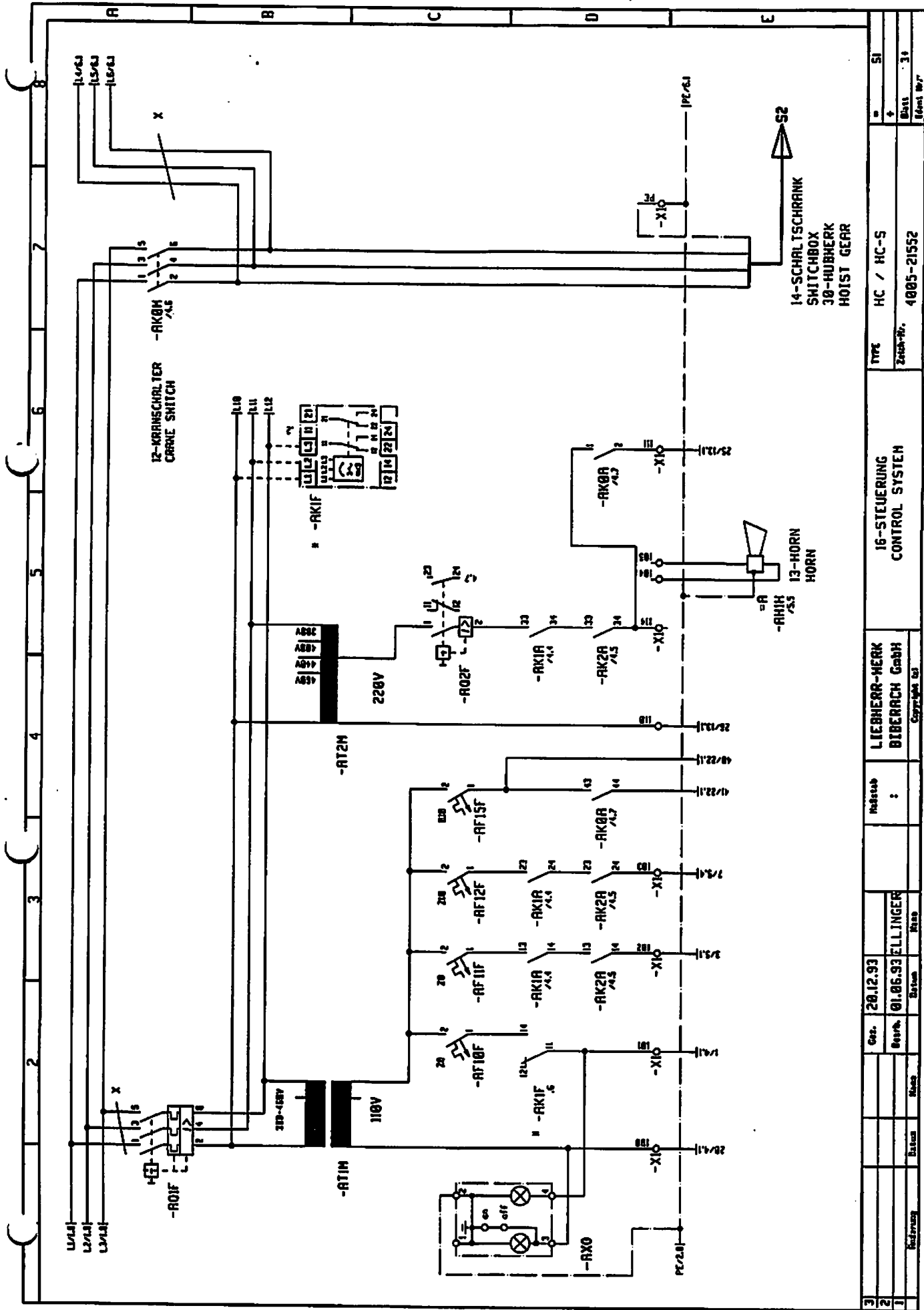

3	Gez.	20.12.93	Maßstab	16-STEUERUNG CONTROL SYSTEM		Typ	HC / HC-5	SI
2	Betr.	01.05.93	Maß	LIEBHERR-MERK BIBERACH GmbH		Zeich.-Nr.	4005-21552	Blatt
1	Datum		Maß	Copyright by				Blatt
								Blatt
								Blatt

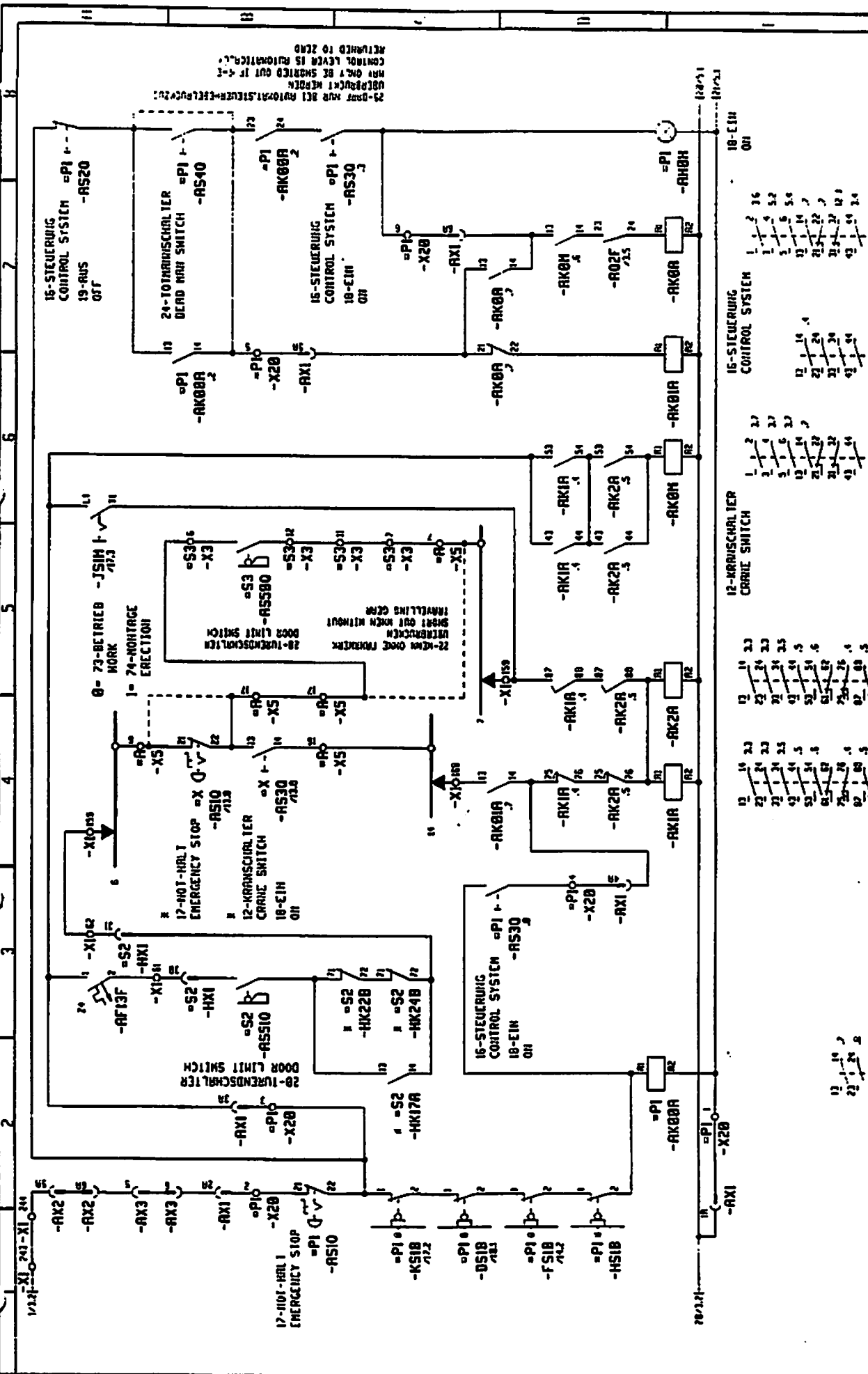

23-DIEN NUR FÜR DIE KRANSTEUERUNG BEFUGT
 UBRIGEN FÜR ANDERE GERÄTE BEFUGT
 NUR GELT BEI ENTSCHLÜSSELUNG
 DER LEISTUNG
 BEI ENTSCHLÜSSELUNG

No.	Abteilung	Datum	Gez.	Blatt
1				
2				
3				

LIEBHERR-WERK BIBERACH GmbH	
Gen.	01.07.93
Blatt	01.06.93
Blatt	ELL INGER

Typ	HC / HC-S
Zeich.-Nr.	4005-21552

1	2	3	4	5	6	7	8	9	10	11	12	13	14	15	16	17	18	19	20	21	22	23	24	25	26	27	28	29	30	31	32	33	34	35	36
1	2	3	4	5	6	7	8	9	10	11	12	13	14	15	16	17	18	19	20	21	22	23	24	25	26	27	28	29	30	31	32	33	34	35	36

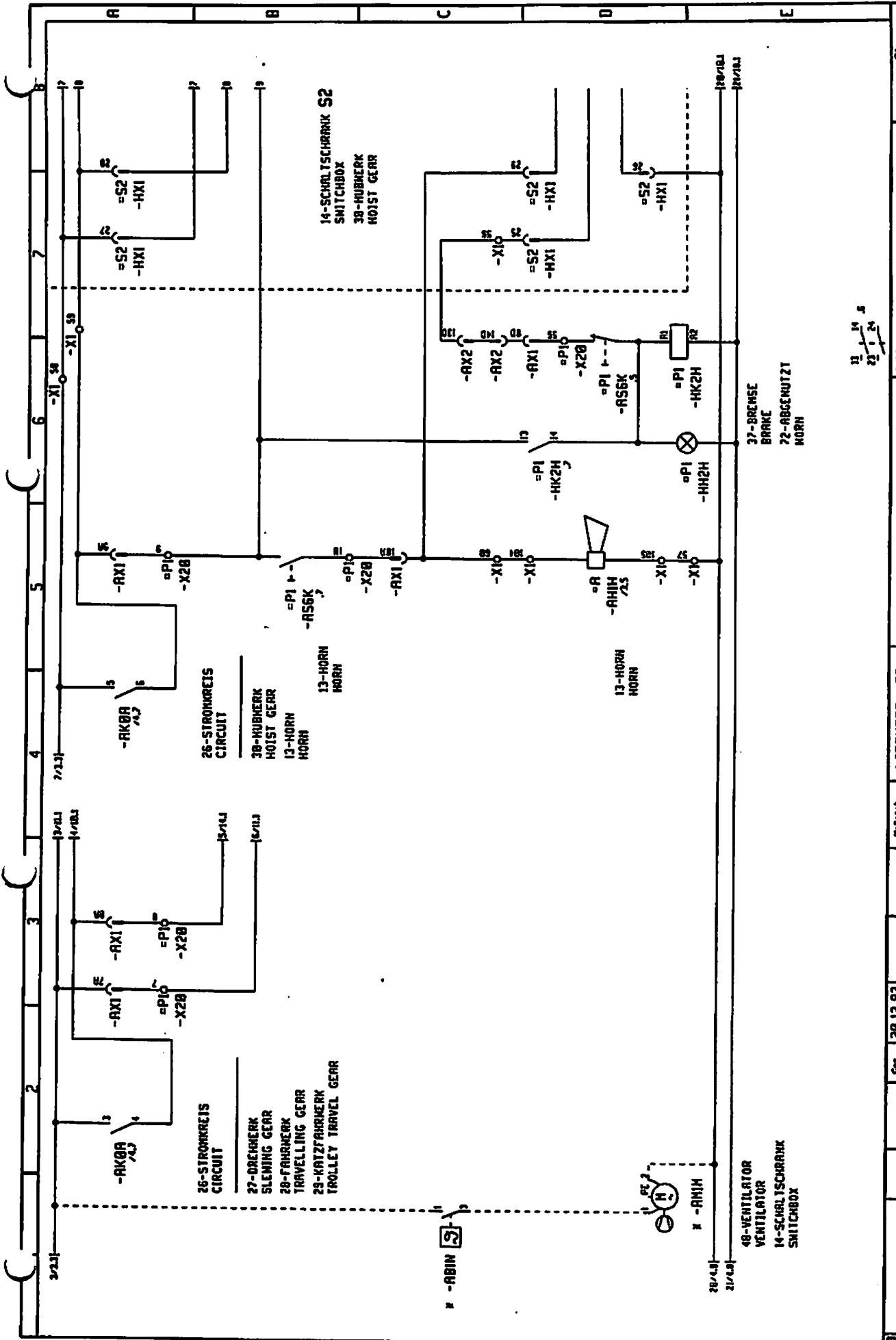

1:1
 1 1 1 1 1 1 1
 2 2 2 2 2 2 2

3	Gen.	28.12.93	Revised					26-STRONKREIS CIRCUIT		TYPE HC / HC-S		SI
2	Drawn	01.06.93	Checked	ELLINGER		: Muller		LIEBHERR-WERK BIBERACH GmbH		Zusch.-Nr. 4885-21552		SI
1	Author		Issue					Copyright ©		Manuf. No.		SI

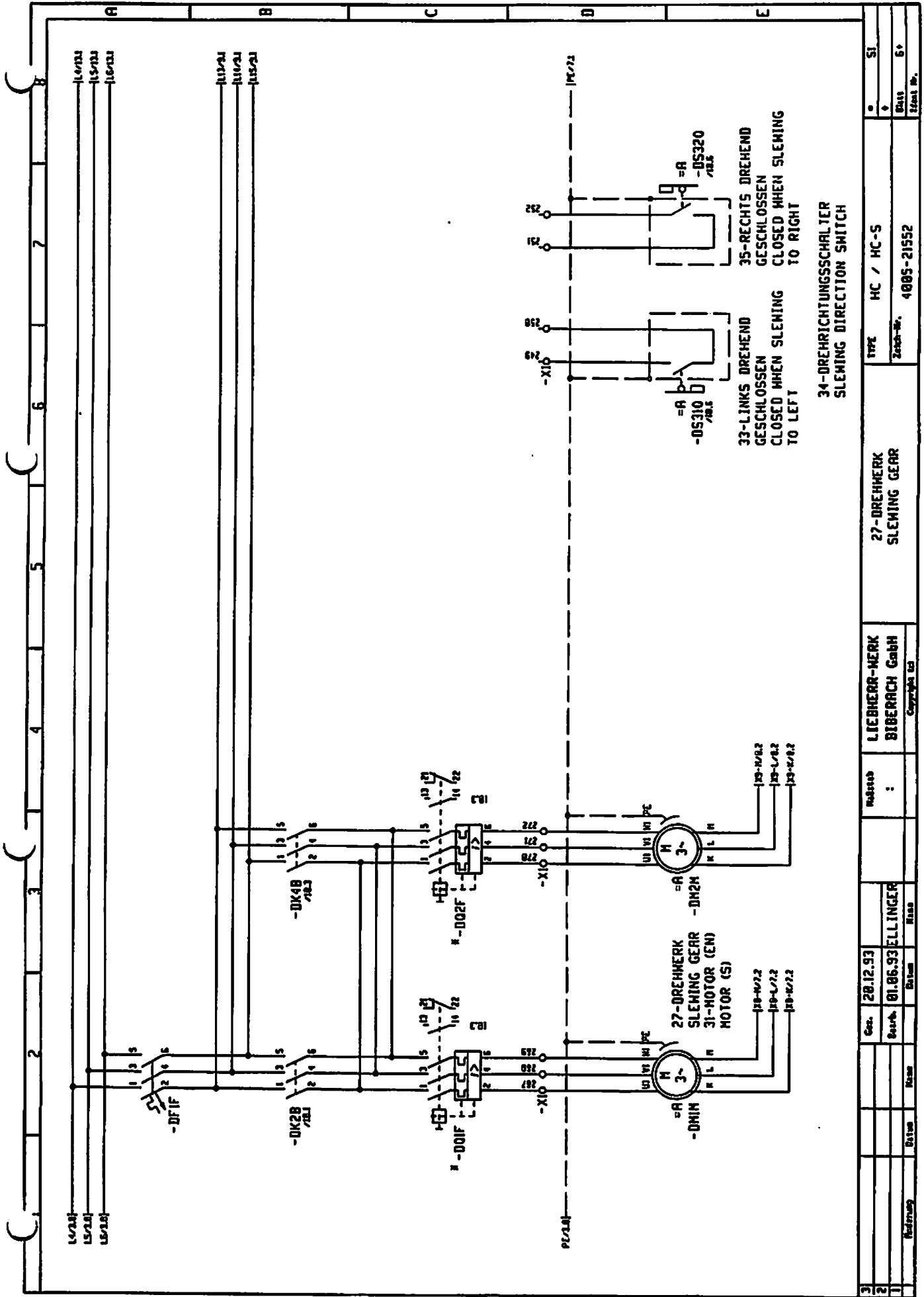

34-DREHRICHTUNGSSCHALTER
SLEWING DIRECTION SWITCH

3	Gen.	20.12.93	LIEBHERR-MERK		TYPE	HC / HC-S	SI
2	Bezb.	01.06.93	BIBERACH GmbH		Zsch.-Nr.	4005-21552	6
1	Bezb.	ELLINGER	Copyright 1993				SI
	Bezb.						SI

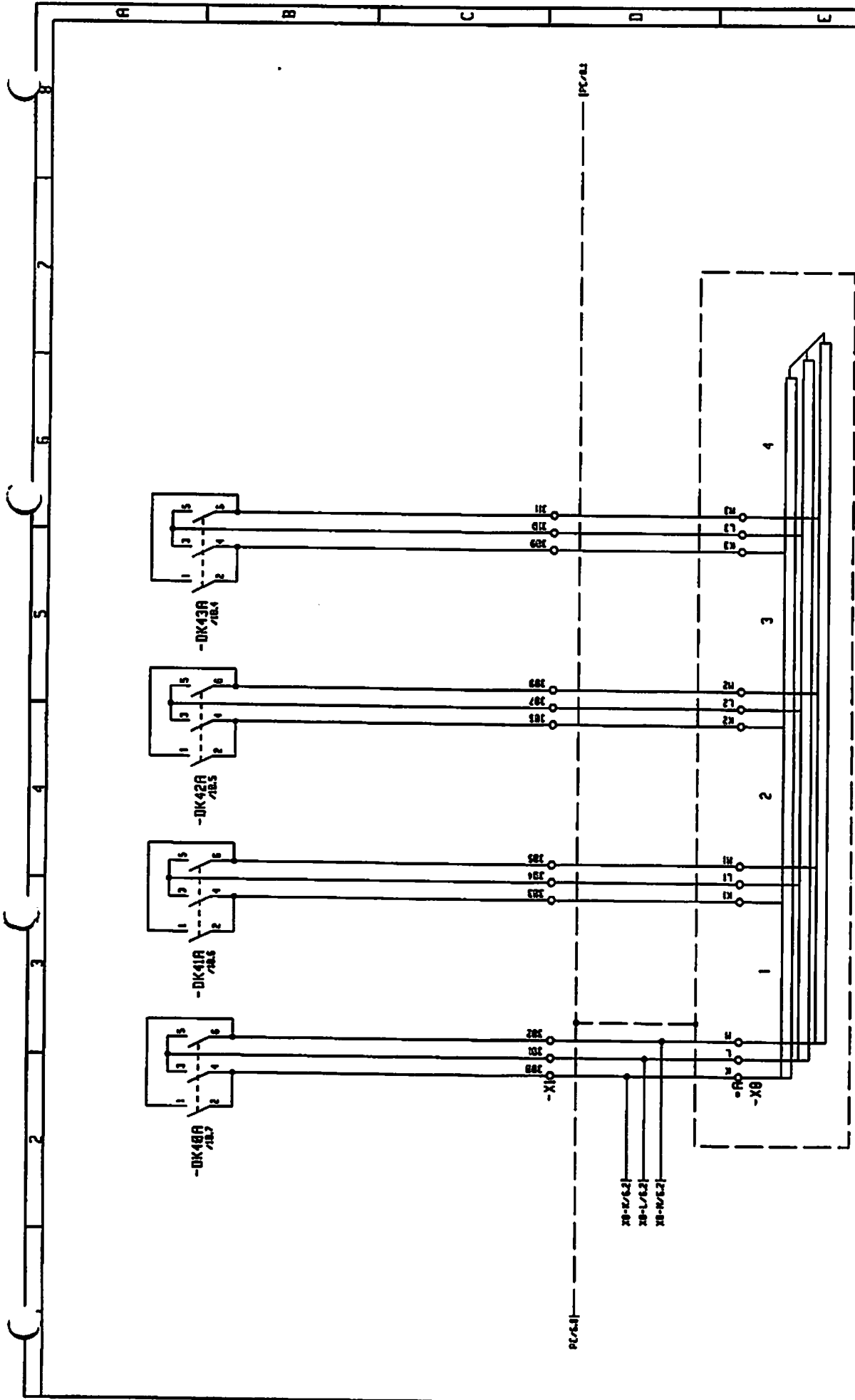

HIDRIH
32-WIDERSTANDSSCHRANK
RESISTOR BOX

3	Gez.	20.12.93	Adress	LIEBHERR-MERK	TYPE	HC / HC-S	SI
2	Beruf.	01.06.93	:	BIBERACH GmbH	Zusch.-Nr.	4085-21552	↓
1	Stab			Copyright GSI			7+
	Datum						Lebens Nr.

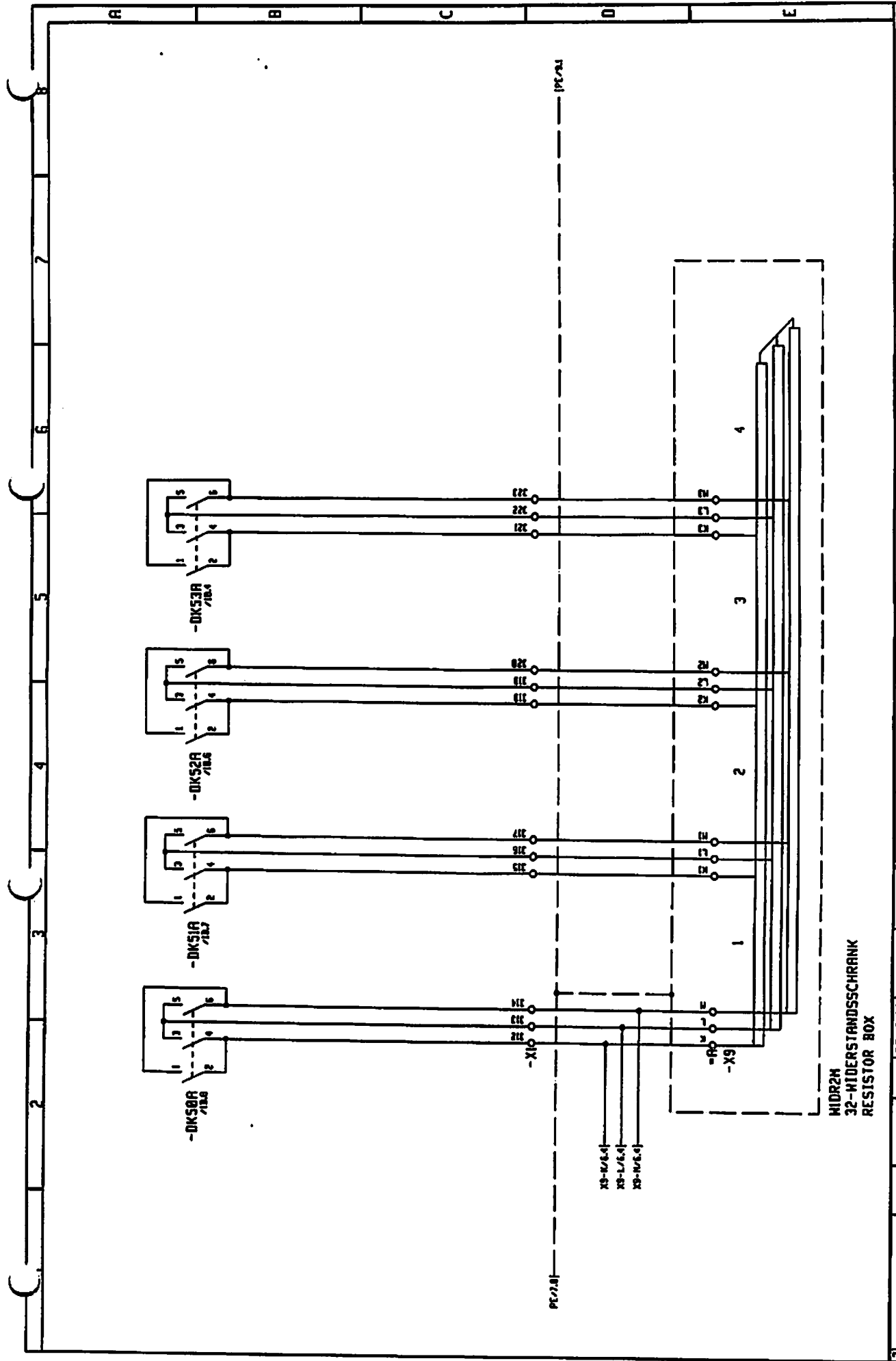

MIDR2H
32-WIDERSTANDSSCHRANK
RESISTOR BOX

3	Gen.	20.12.93	Artikelnr.	LIEBHERR-MERK	TYPE	HC / HC-S	SI
2	Besch.	01.06.93	:	BIBERACH GmbH	Zust.-Nr.	4005-21552	81
1	Datum			Copyright ©			81
	Reviz.						
	Erstellt						

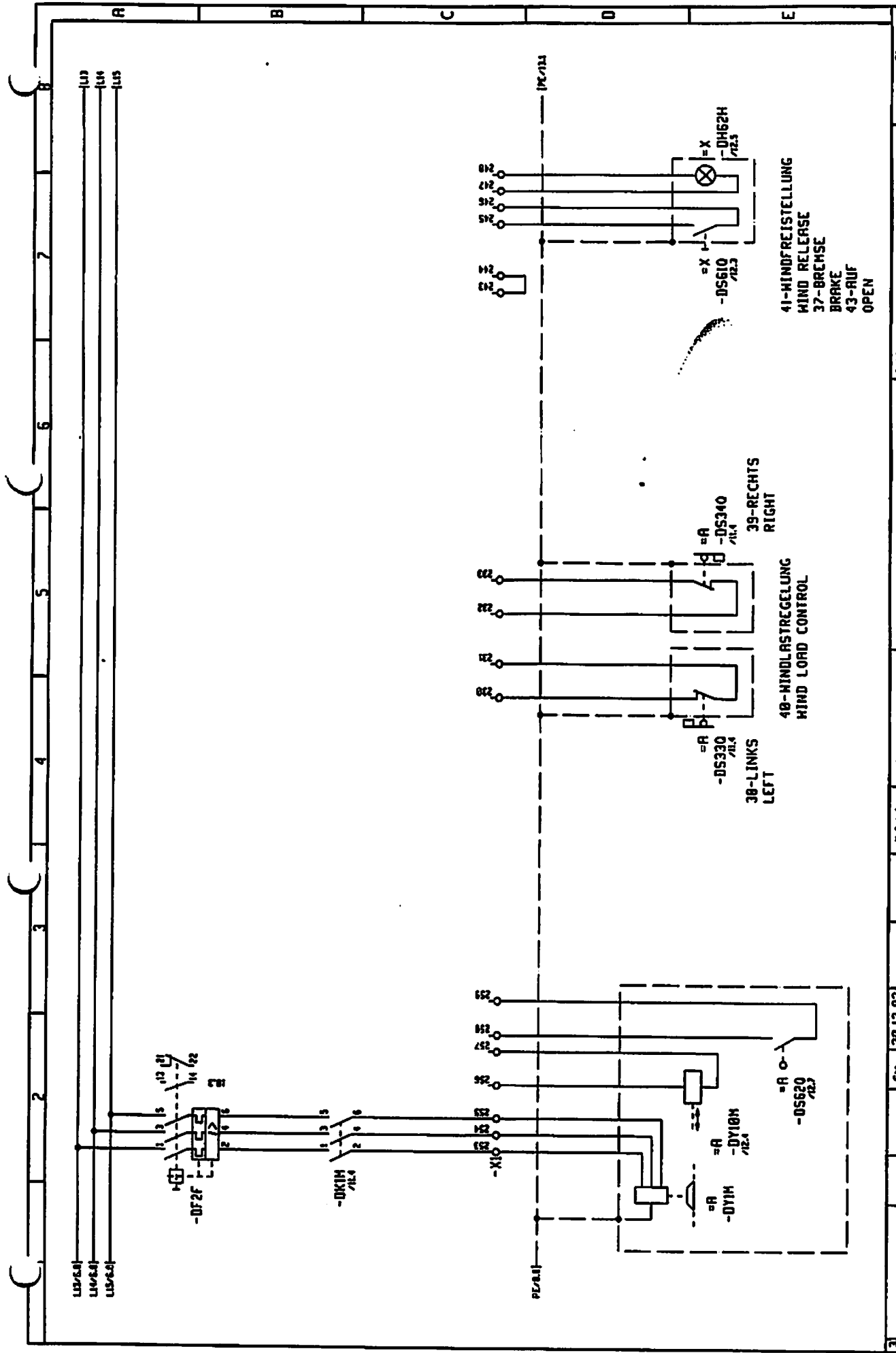

41-HINDFREISTELLUNG
 WIND RELEASE
 37-BREHSE
 BRAKE
 43-AUF
 OPEN

39-RECHTS
 RIGHT

40-HINDLASTSTREGELUNG
 HIND LOAD CONTROL

38-LINKS
 LEFT

3	Gez.	20.12.93	Maßstab	LIEBHERR-MERK	Typ	HC / HC-S	SI
2	Bezeichnet	01.06.93	:	BITBERG CabH	Zust-Nr.	4085-21552	91
1	Bezeichnet	ELLINGER	Copyright ©				16231 Nr.

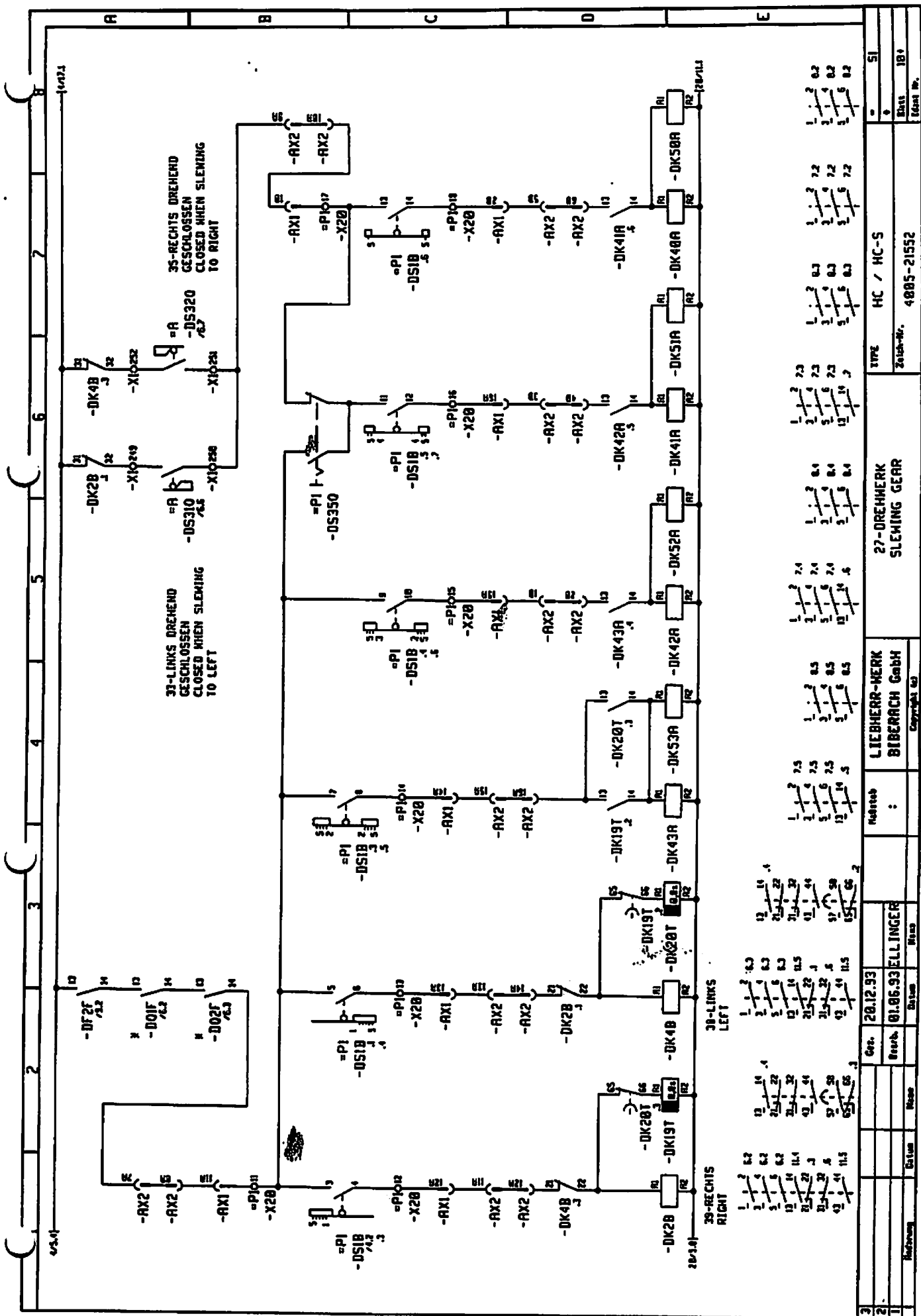

3	Ger.	20.12.93	Maßstab	LIEBHERR-MERK	TYPE	HC / HC-S	SI
2	Bezb.	01.06.93	:	BIBERACH GmbH	27-DREHMERK		
1	Bezb.	ELLINGER			SLEWING GEAR	Zeich.-Nr.	IB1
	Bezb.					4885-21552	Ident. Nr.

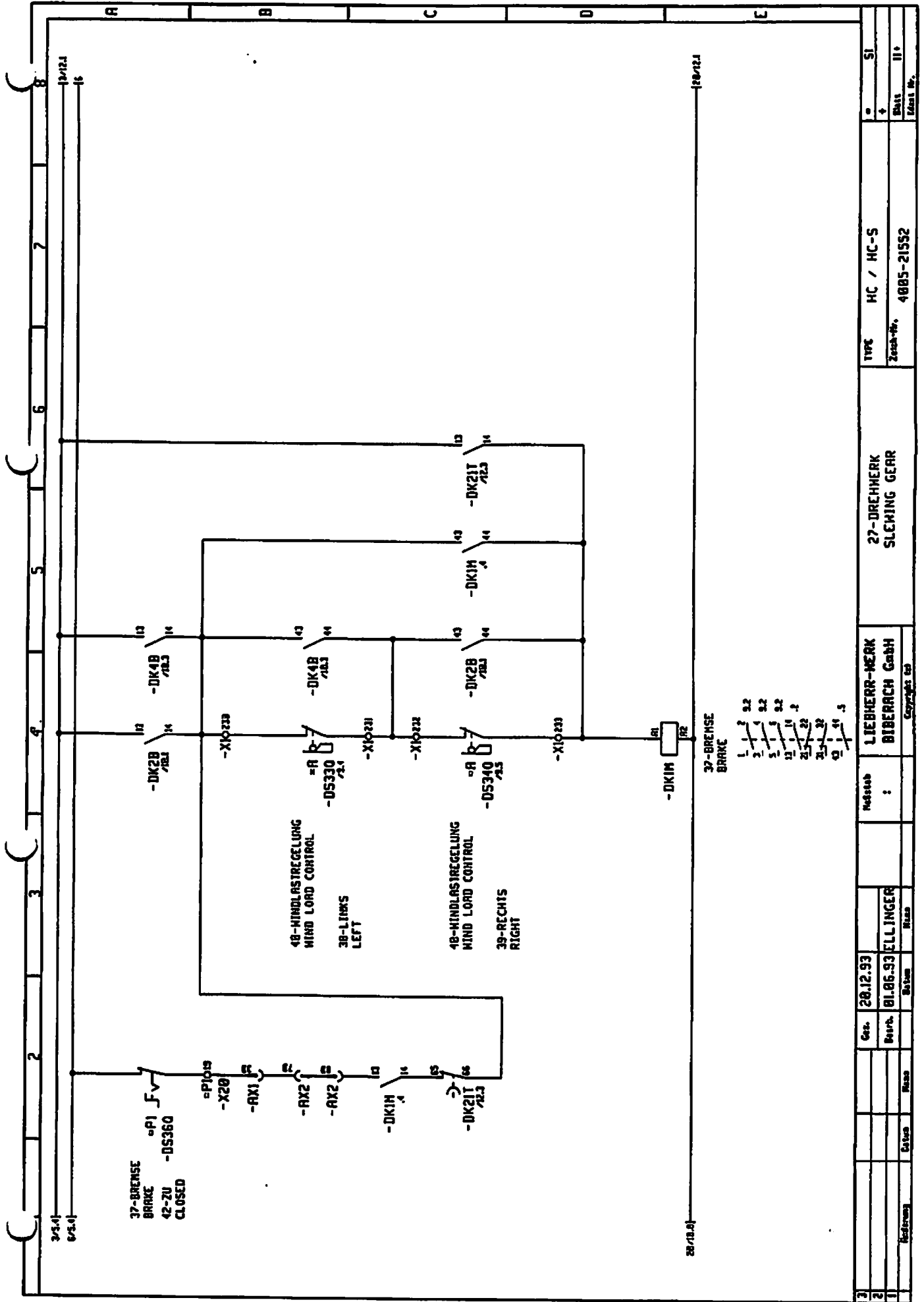

3	Gen.	20.12.93	Modell	LIEBHERR-MERK	27-DREHWERK	TYP	HC / HC-S	SI
2	Rev.	01.06.93		BIBERACH GmbH	SLEHING GEAR	Zust.-Nr.	4805-21552	SI
1	Rev.							II
	Rev.							Man. Nr.

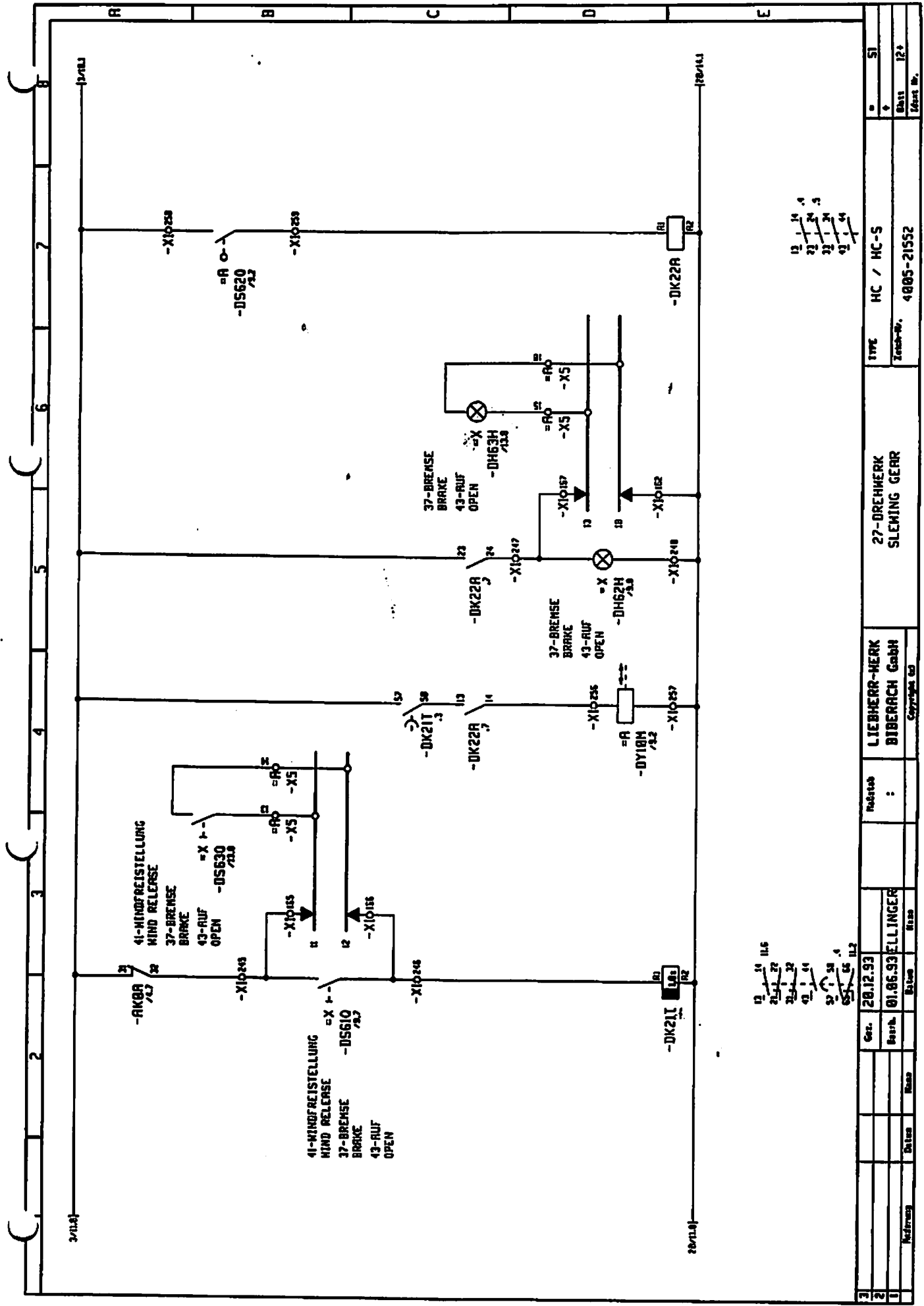

3	Gen.	28.12.93	Rev.	01.05.93	ELLINGER	Produkt	LIEBHERR-HERK BIBIRACH GmbH	TYPE	HC / HC-S	№	51
2	Rev.	01.05.93	Rev.	01.05.93	ELLINGER	Produkt	LIEBHERR-HERK BIBIRACH GmbH	Zeich.-Nr.	4805-21552	Blatt	12
1	Rev.	01.05.93	Rev.	01.05.93	ELLINGER	Produkt	LIEBHERR-HERK BIBIRACH GmbH	Zeich.-Nr.	4805-21552	Blatt	12

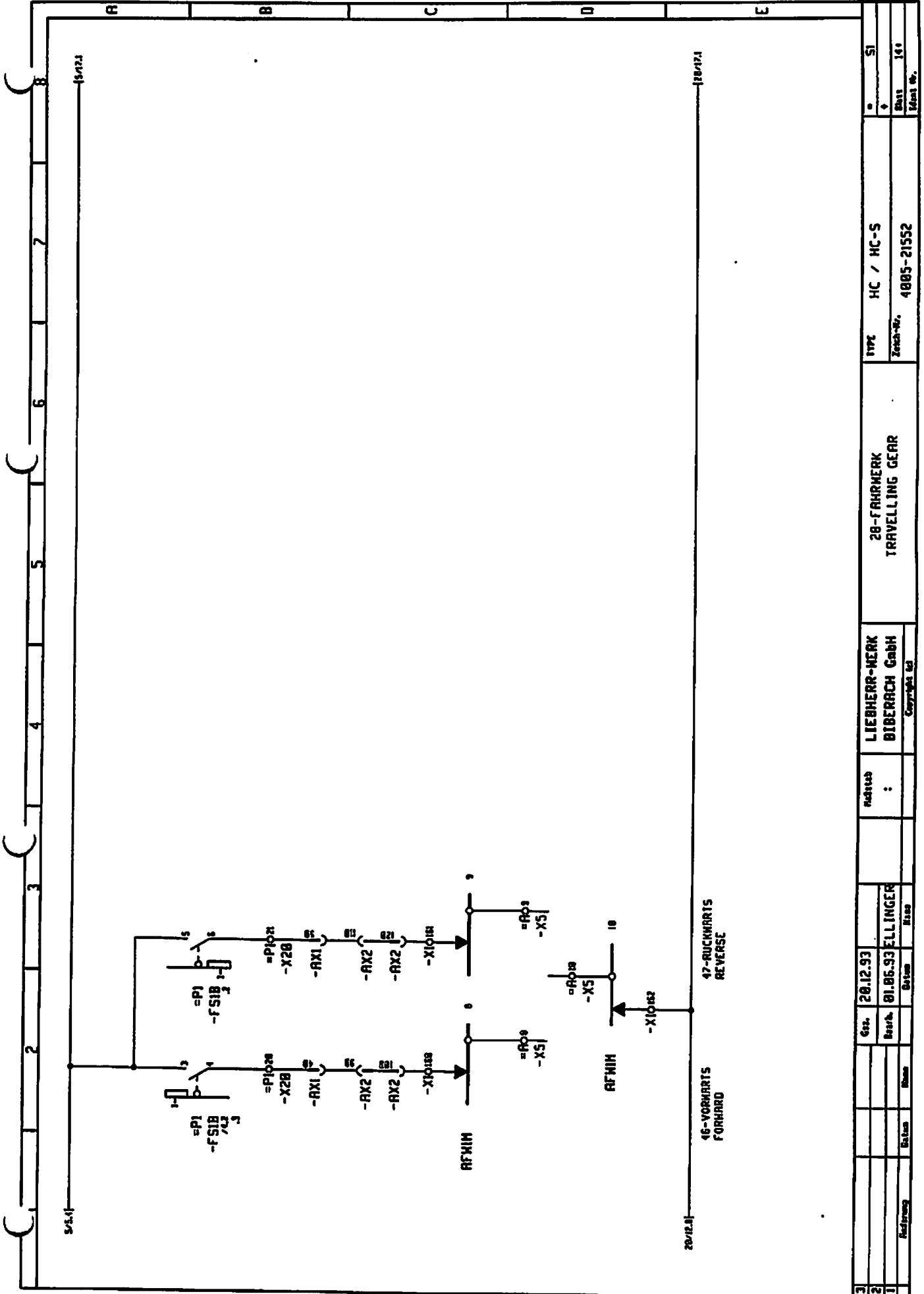

3		Ger.	20.12.93	Datum	Eilag					S1	
2		Bruf.	01.06.93	Datum	Eilag					Blatt	
1										141	
										Ident. Nr.	
										TYPE	HC / HC-S
										Zeich.-Nr.	4805-21552
										LIEBHERR-MARK BIBERACH GMBH	
										20-FÄHRWERK TRAVELLING GEAR	
										<small>Copyright Ltd</small>	
										<small>Address</small>	

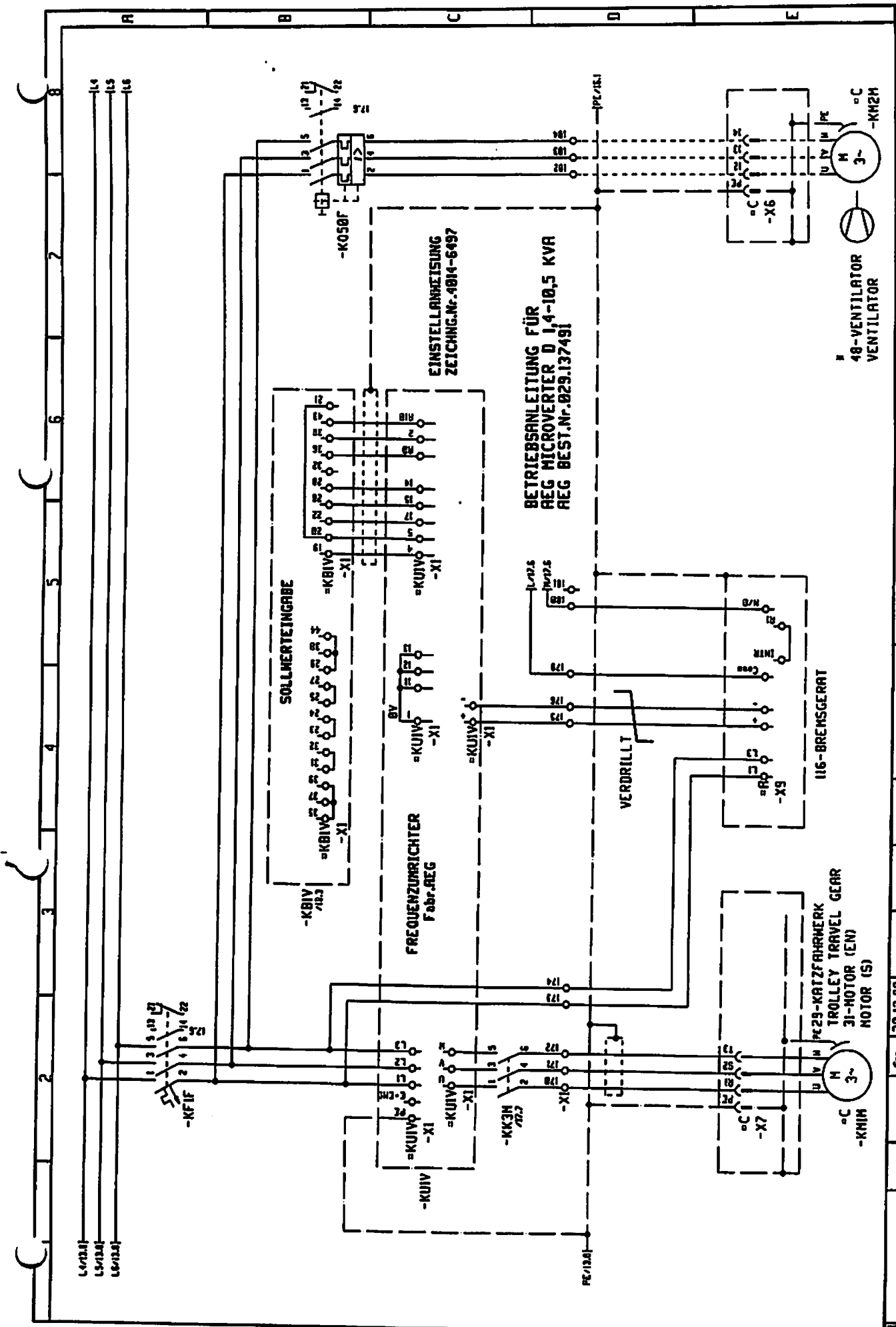

3	Gen.	28.12.93	Kaufst.		LIEBHERR-MERK BIBERACH GmbH		29-KATZFAHRWERK TROLLEY TRAVEL GEAR		TYPE	HC / HC-S	SI
2	Datum	21.02.93	:		COPYRIGT 93				Zerisch-Nr.	4885-21552	SI
1	Best-Nr.	81.86.93									SI
	Best-Nr.	ELLINGER									SI
	Best-Nr.	ELLINGER									SI
	Best-Nr.	ELLINGER									SI

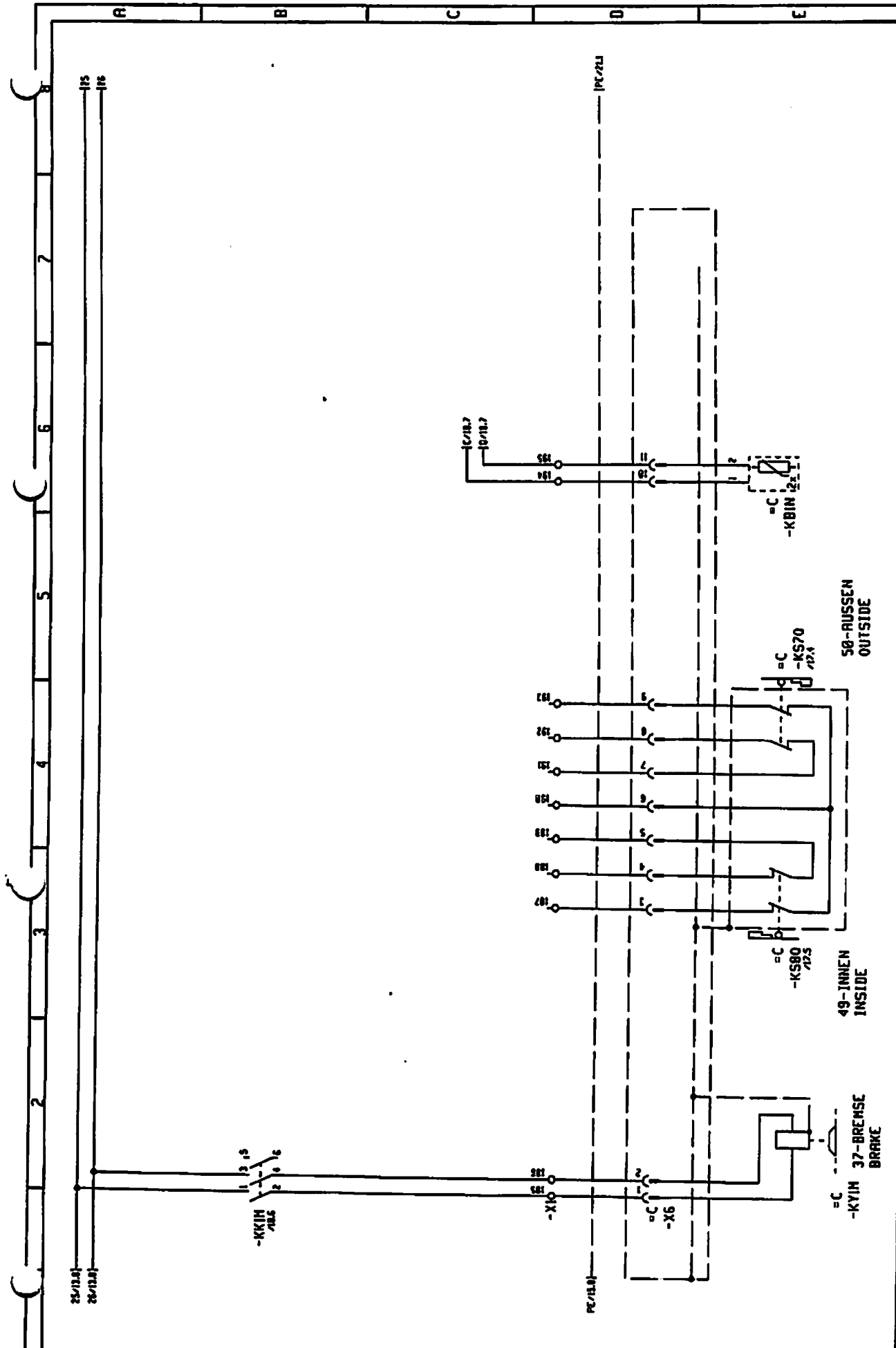

3																					SI
2																					HC / HC-S
1																					Zeich.-Nr. 4085-21552
										29-KRATZFAHRWERK TROLLEY TRAVEL GEAR LTBEHERR-WERK BIBERACH GmbH Gernsbühlstr. 63											
										Gen. 20.12.93 Matr. 01.06.93 ELLINGER											
										Zeich.-Nr. Blatt Stück Blatt											
										15* Stück Nr.											

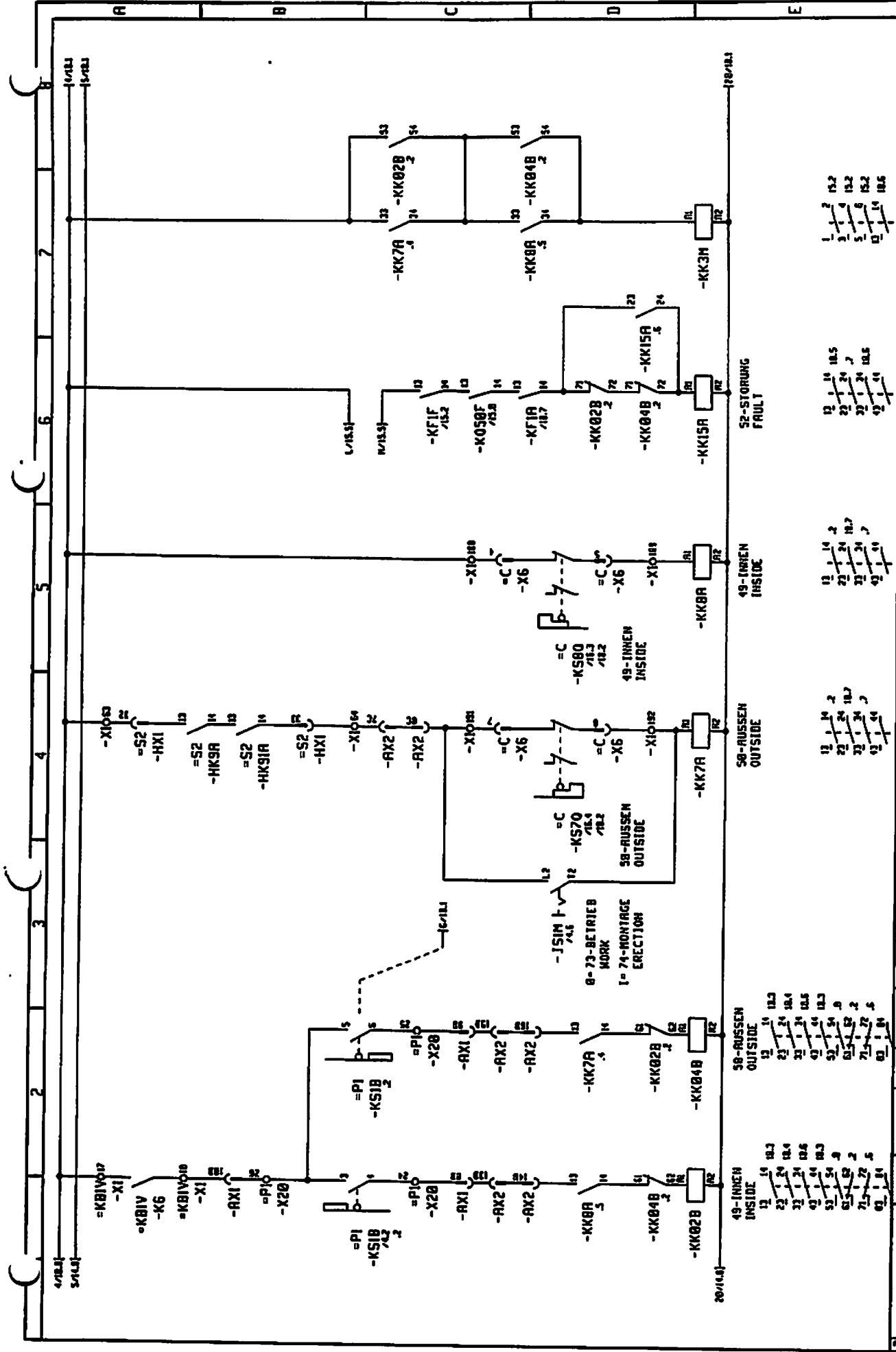

3	Erst.	28.12.93	Date		Typ HC / HC-S Zeich.-Nr. 4005-21552	SI Blatt 17 Abest. Nr.
2	Gepr.	01.06.93	Date			
1	Entwurf	ELLINGER	Name			
Hersteller : LIEBHERR-MERK BIBERACH GmbH			Patent :		Copyright 93	
29-KATZFAHRWERK TROLLEY TRAVEL GEAR						

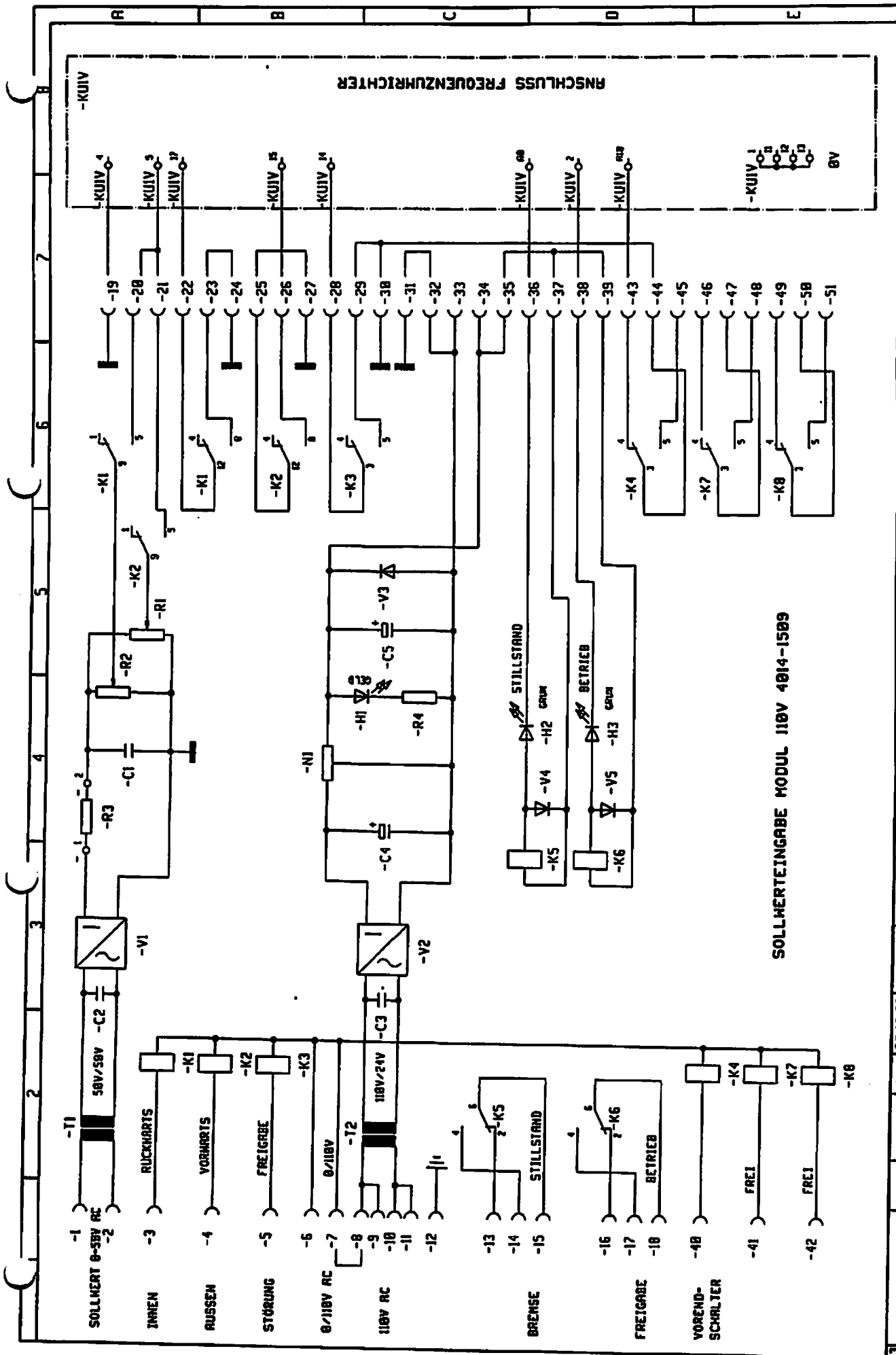

SOLLWERTEINGABE MODUL 110V 4014-1509

3	Genr.	28.12.93	Modultab	LIEBHERR-MERK BIBERACH GmbH		SOLLWERTEINGANG FREQUENZUMR.		TYPE	HC / HC-S	SI
2	Beitrag	25.10.93	Zeich.-Nr.	BIBERACH GmbH		GULTIG AB 01.12.1993		Zersch.-Nr.	4005-21552	Blatt
1	Zeich.-Nr.	4005-21552	Copyright	© 1993						19+
	Blatt									Blatt
	Blatt									Blatt

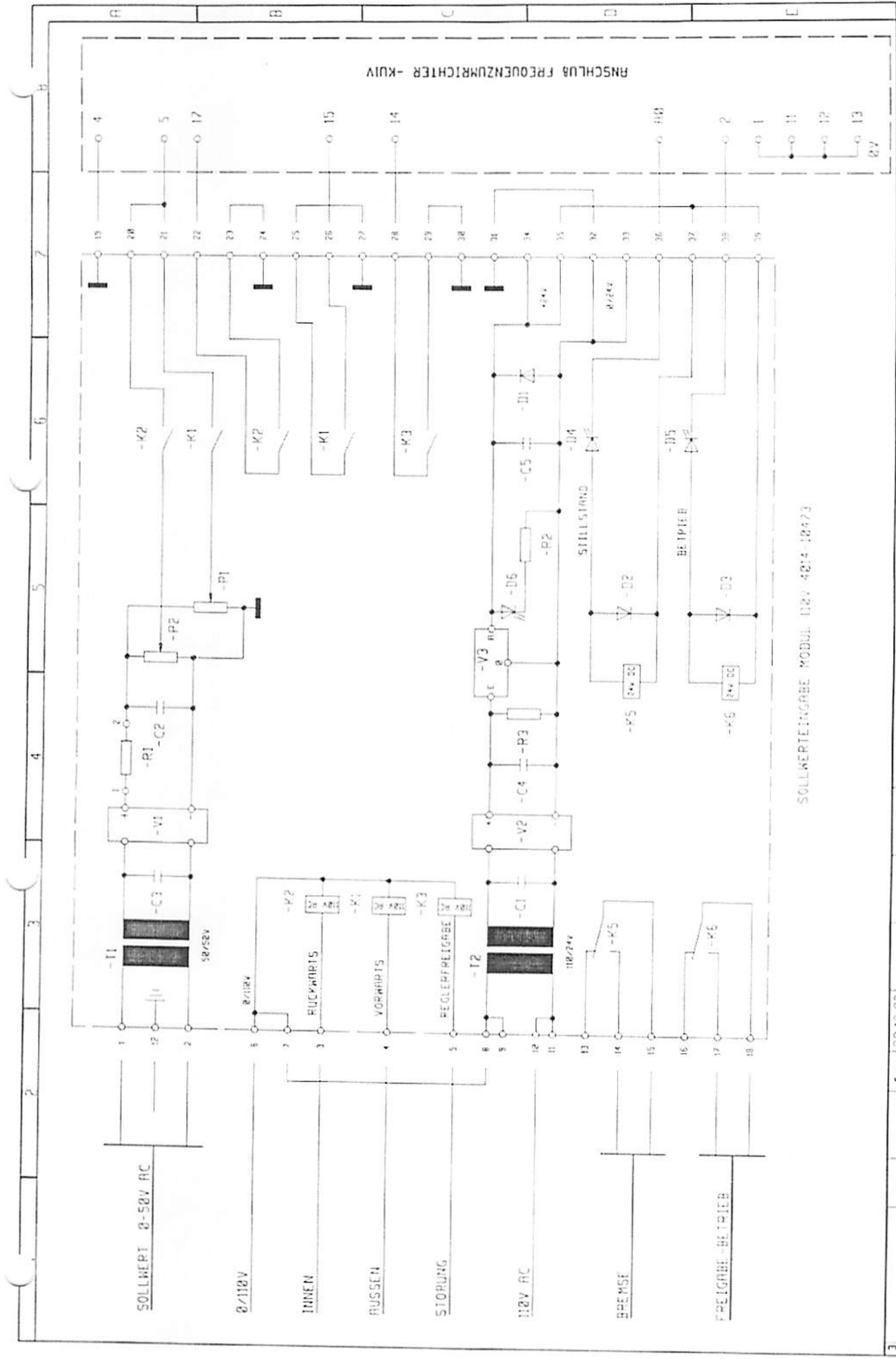

ANSCHLUSSE FREQUENZUMRICHTER - KUUV

SOLLWERTEINGABE MODUL 112V 4214-10473

3	Gez.	28.12.93	Matr.Nr.	LIEBHERR-WERK BIBERACH GmbH	TYPE	HC / HC-5	SI
2	Bearb.	01.06.93	Name	SOLLWERTEINGANG FREQUENZUMP.	Zeich.-Nr.	4805-21557	20
1	Red.		Datum	GÜLTIG BIS 30.11.1993			Ident. Nr.

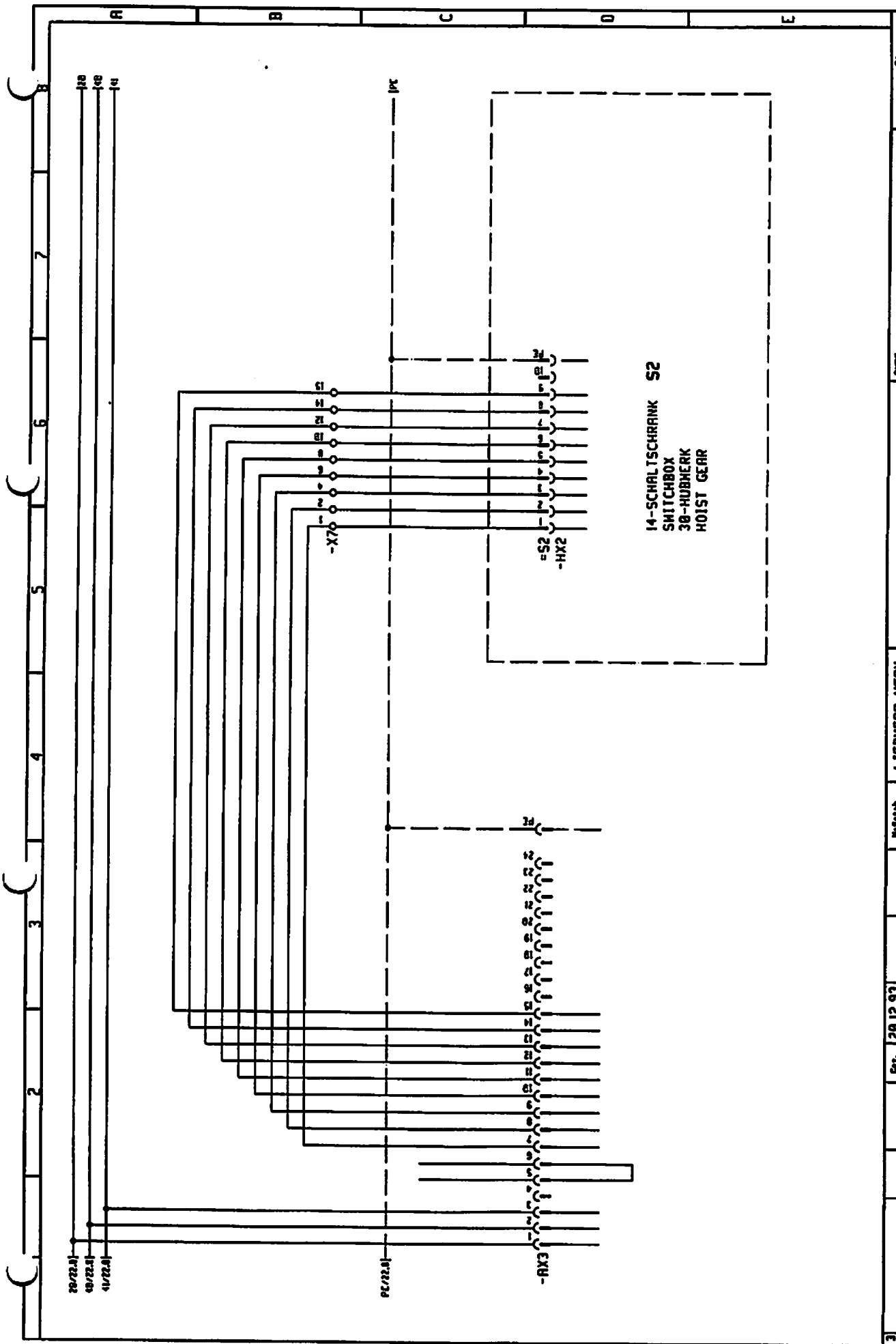

14-SCHALTSCHRANK S2
 SWITCHBOX
 38-HUBBERK
 HOIST GEAR

3	Gez.	28.12.93	LIEBHERR-MERK		S-STECKVORRICHTUNG		TYPE	HC / HC-S	-	51
2	Betr.	01.06.93	BIBERACH GmbH		PLUG-IN DEVICE		Zeich.-Nr.	4885-21552	9	230
1	Revisions		Copyright ©						Breit	
									Ediert	
									Ediert	

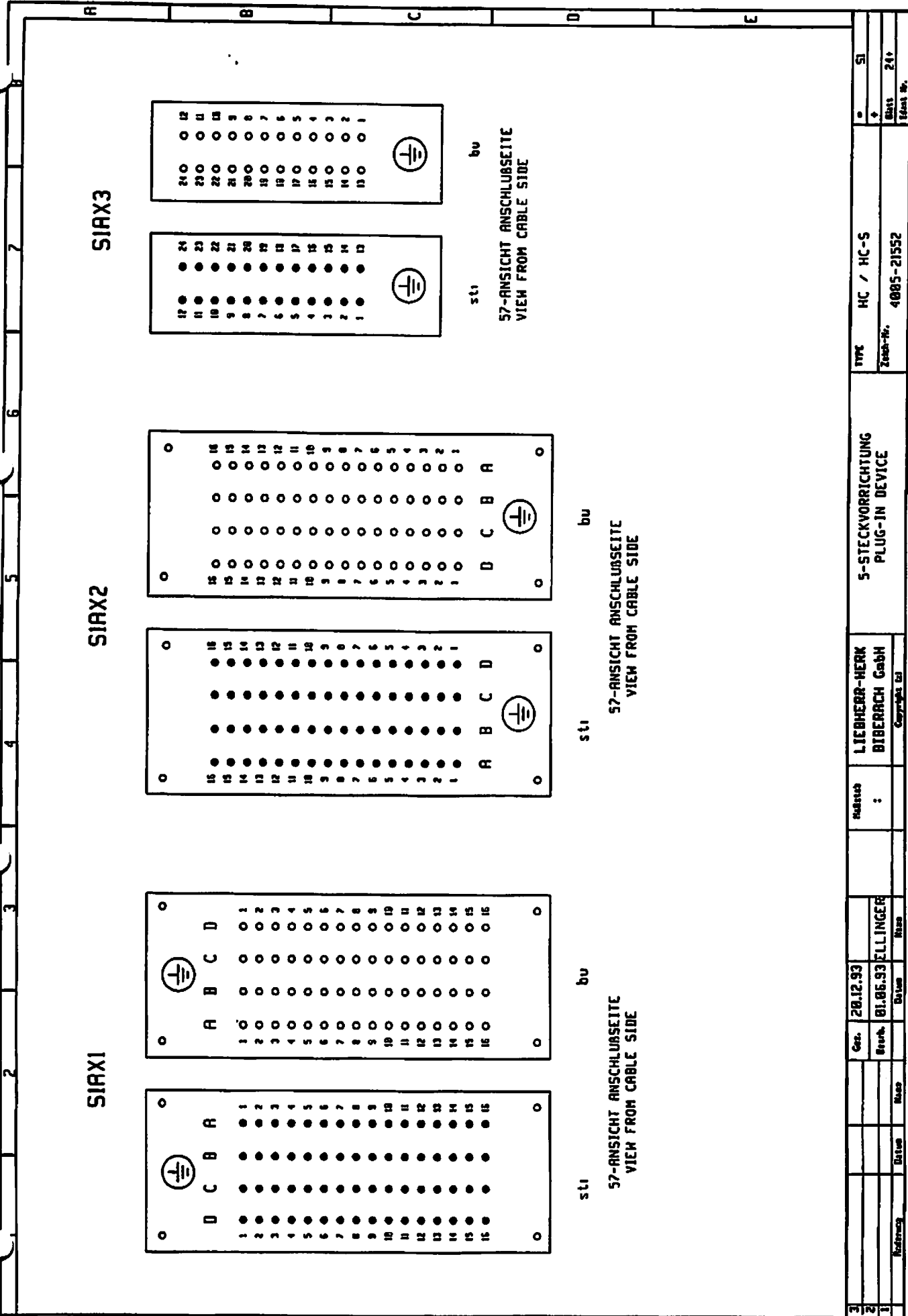

stl bu
 57-ANSICHT ANSCHLUSSEITE
 VIEW FROM CABLE SIDE

stl bu
 57-ANSICHT ANSCHLUSSEITE
 VIEW FROM CABLE SIDE

stl bu
 57-ANSICHT ANSCHLUSSEITE
 VIEW FROM CABLE SIDE

3											Typ	HC / HC-S		SI	
2											Zeich.-Nr.	4005-21552		Blatt	24+
1														Edm.-Nr.	
	Best.-Nr.	Datum	Blatt	LIEBHERR-HERK BIBERACH GmbH Copyright Gd		5-STECKVORRICHTUNG PLUG-IN DEVICE									
	Ges. 20.12.93	Datum	Riese	: Halstüb		57-ANSICHT ANSCHLUSSEITE VIEW FROM CABLE SIDE									
	Beurh. 01.06.93	Datum	Riese	: ELLINGER		57-ANSICHT ANSCHLUSSEITE VIEW FROM CABLE SIDE									

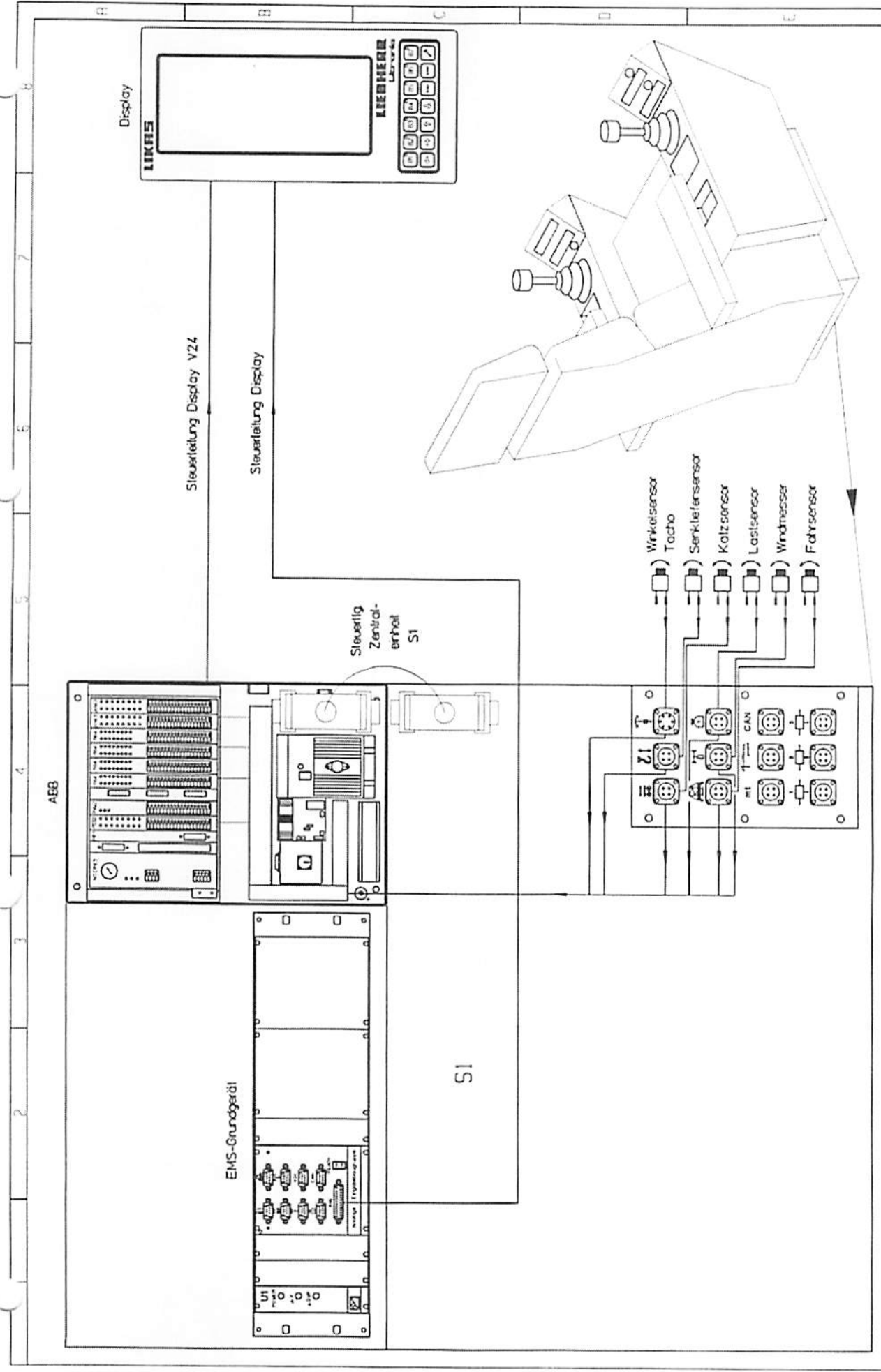

3														SI		
2		Ger.	20.12.93											TYPE	HC / HC-5	
1		Berb.	08.10.93	PELLINGER										Zeich.-Nr.	4285-21552	
															Blatt	25
																Ident. Nr.
											LIEBHERR-HERK					
											BIBERACH GmbH					
											Copyright (c)					

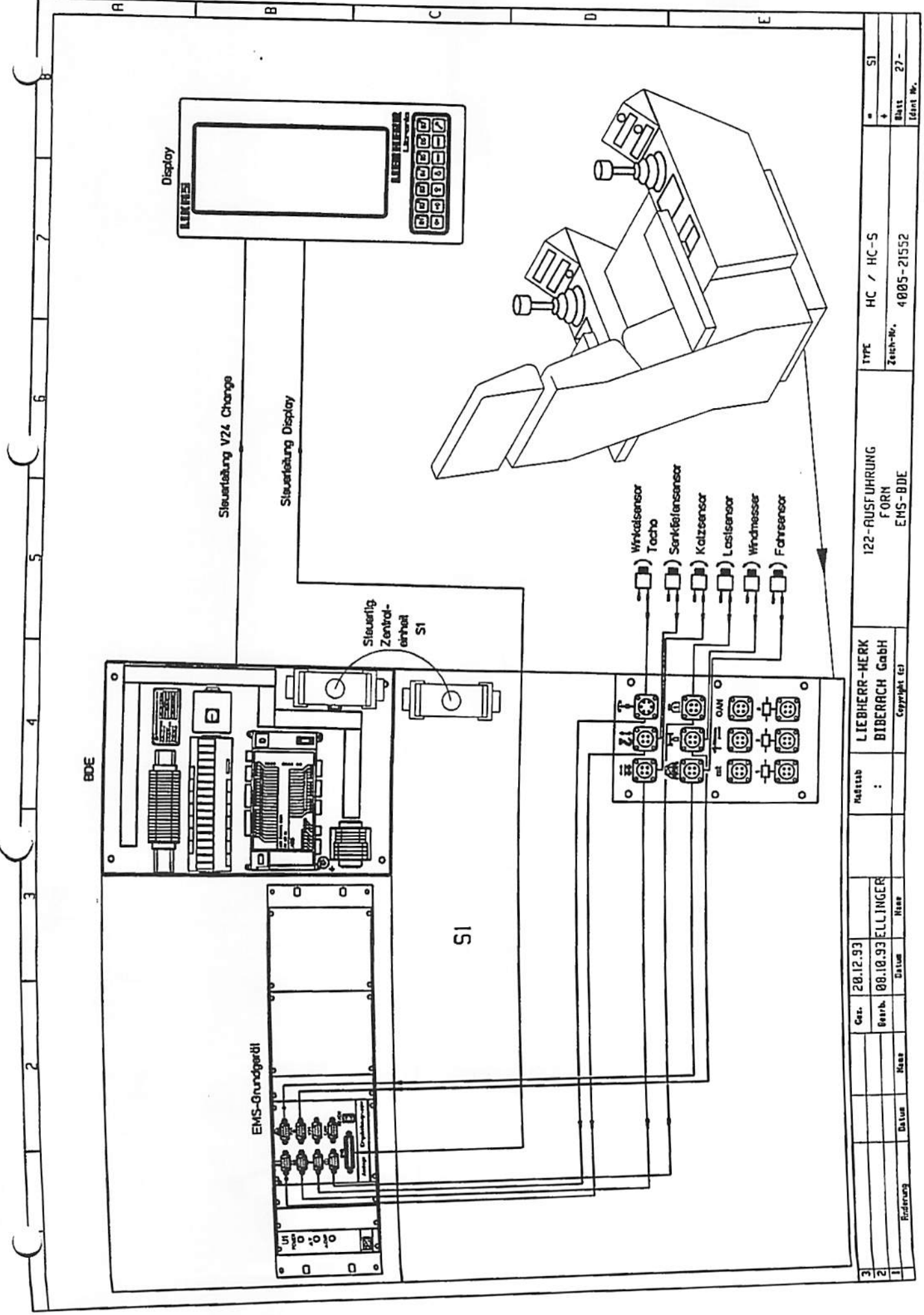

3	Enderung	Datum	Heute	Gez.	20.12.93	Matr.Nr.	LIEBHERR-MERK BIBERACH Gabh		TYPE	HC / HC-S	№	S1
2		Datum	Heute	Gez.	08.10.93	ELLINGER	122-AUSFUHRUNG FORM EMS-BDE		Zersch-Nr.	4005-21552	+	Batt
1		Datum	Heute	Gez.			Copyright (c)					Ident. Nr.