

3					Ges.	06.02.91	ELLINGER	LIEBHERR WERK	II-EINSPEISUNG	TYPE	HC+ECH	=	SI
2					Bearb.			BIBERRACH		Zeich.-Nr.	4005-21439	+	
1					Datum			Copyright (c)				Blatt	1+
	Änderung		Datum		Neue								

* = 10-NICHT SERIENMÄßIG

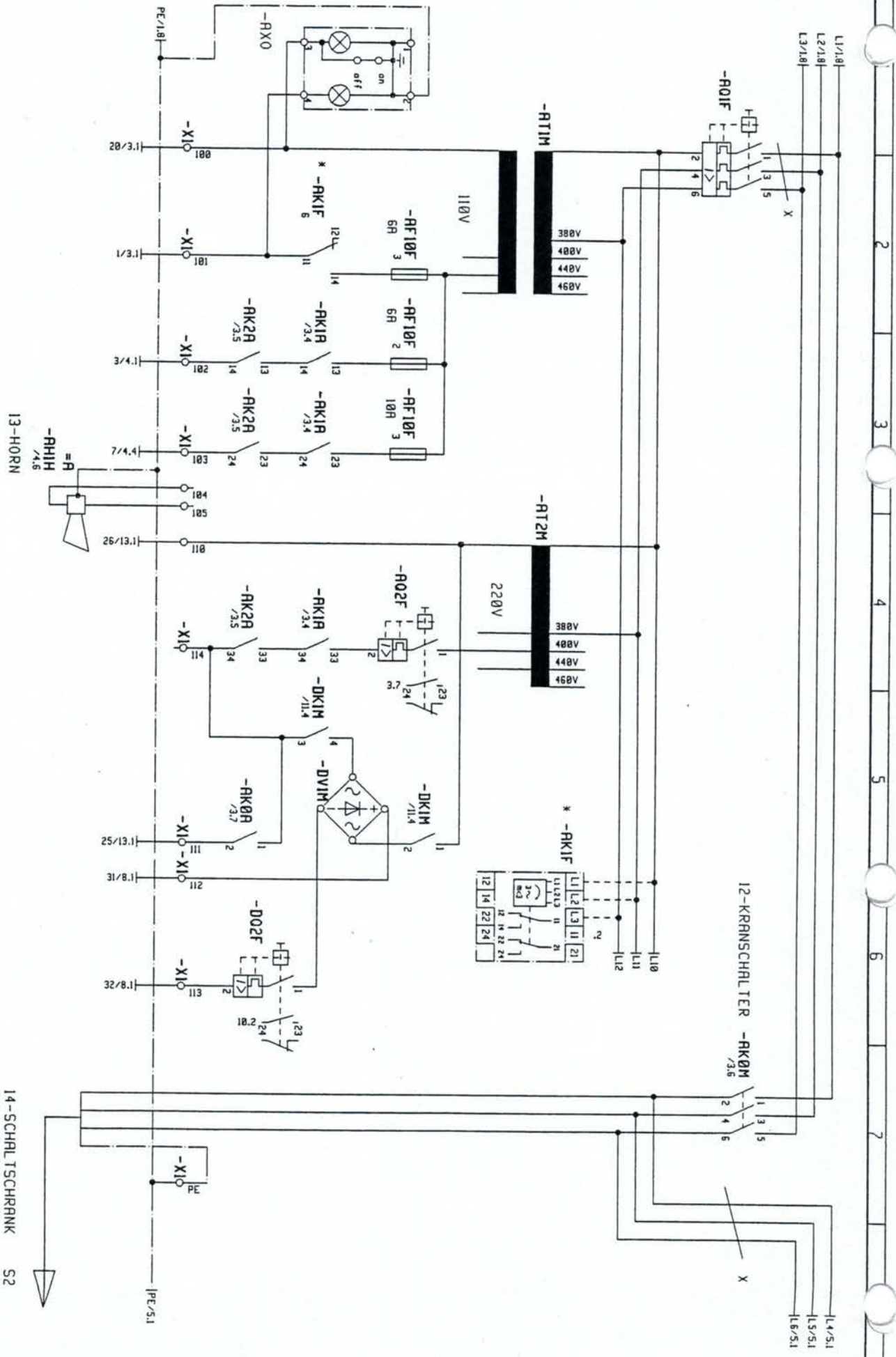

14-SCHALTSCHRANK S2
30-HUBWERK

Ger. 06.02.91 ELLINGER				LIEBHERR WERK		16-STEUERUNG		TYPE HC+ECH	SI
Aenderung				BIBERRCH		Copyright (c)		Zeich-Nr. 4005-21439	Blatt 2+
3	2	1							
3	2	1	Datum	Neue	Bearb.	Datum	Neue		

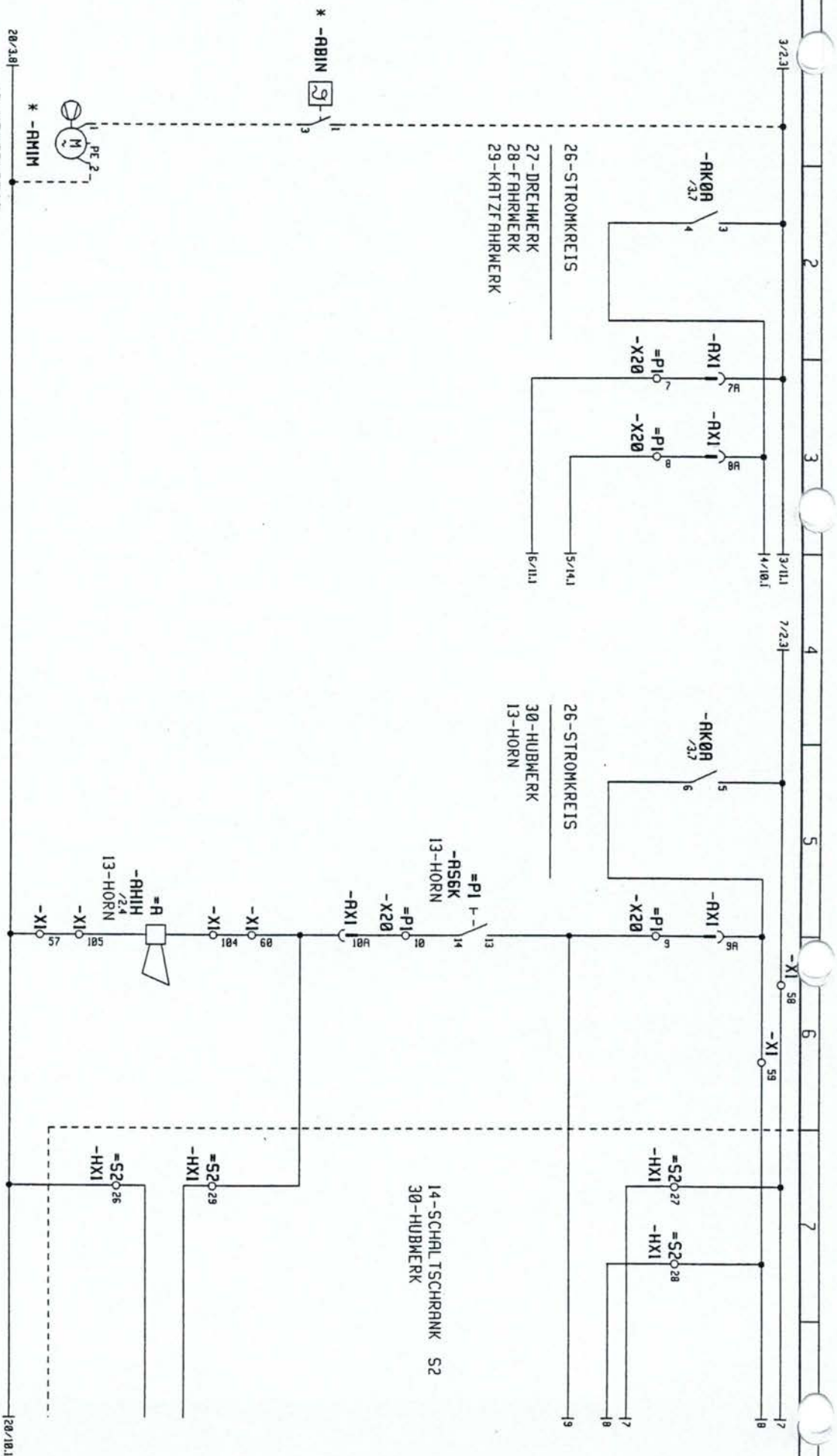

26-STROMKREIS
 27 - DREHMERK
 28 - FAHRWERK
 29 - KATZFAHRWERK

26-STROMKREIS
 30 - HUBWERK
 13 - HORN

14-SCHL TSCHRANK S2
 30-HUBWERK

48-VENTILATOR
 14-SCHL TSCHRANK

3														
2														
1														
	Änderung	Datum	Nr.	Bez.	Datum	Nr.	Gez. 06.02.91 ELLINGER		LIEBHERR MERK BIBERRICH Copyright tel	26-STROMKREISE	TYPE HC+ECH	Zeich.-Nr. 4005-21439	Blatt	4+

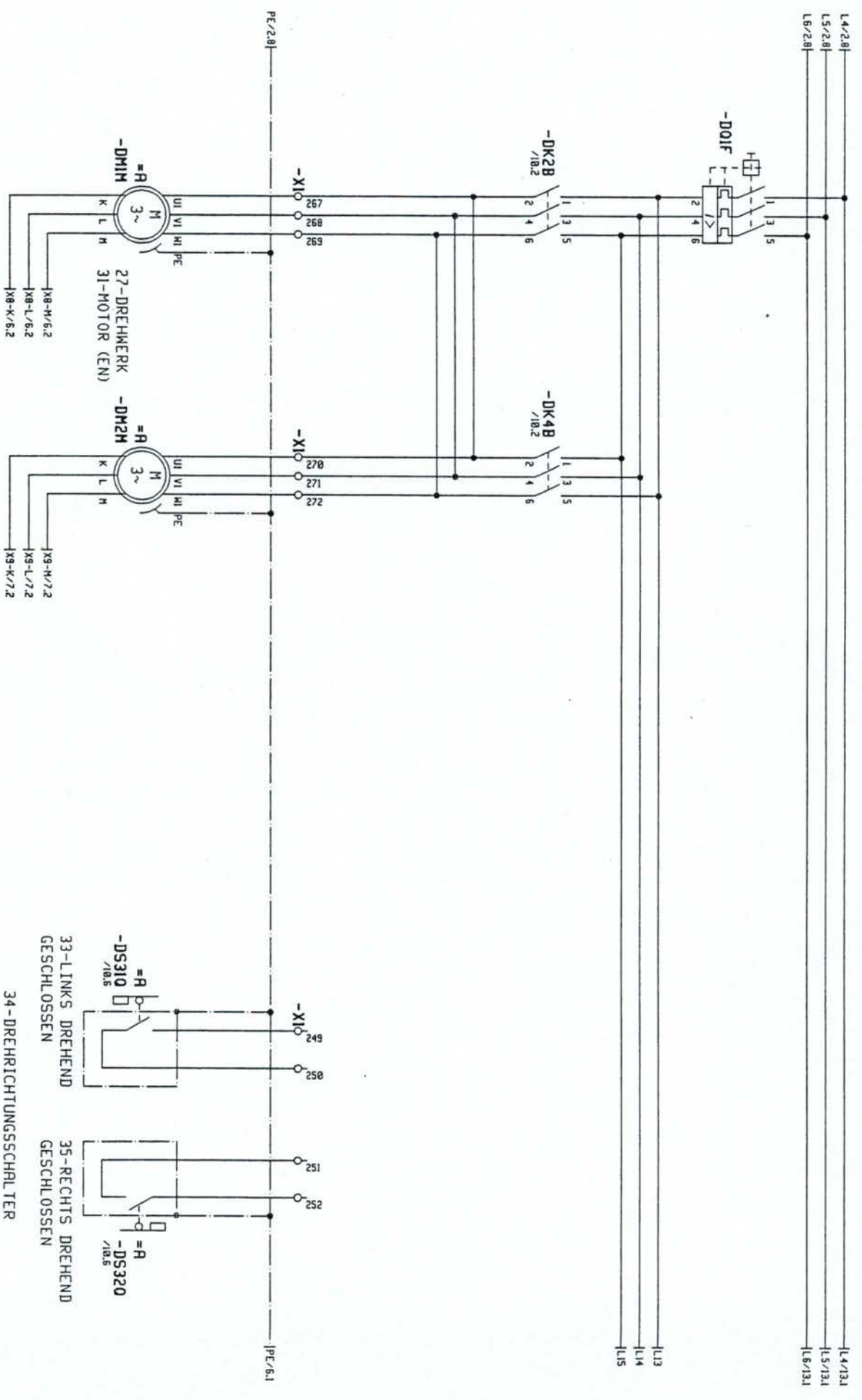

3		Date	Name	Zeich.-Nr. 4005-21439	<table border="1"> <tr> <td colspan="2" data-bbox="71 87 175 218">Änderung</td> <td data-bbox="71 218 175 305">Date</td> <td data-bbox="71 305 175 393">Name</td> <td data-bbox="71 393 175 480">Chr.</td> <td data-bbox="71 480 175 567">Date</td> <td data-bbox="71 567 175 655">Name</td> </tr> <tr> <td colspan="2"></td> <td></td> <td></td> <td></td> <td></td> <td></td> </tr> <tr> <td colspan="2"></td> <td></td> <td></td> <td></td> <td></td> <td></td> </tr> </table>	Änderung		Date	Name	Chr.	Date	Name														
Änderung		Date	Name	Chr.	Date	Name																				
LIEBHERR WERK BIBERACH Copyright (c)					27-DREHWERK		TYPE HC+ECH		SI																	
					06.02.91 ELLINGER		+		SI																	

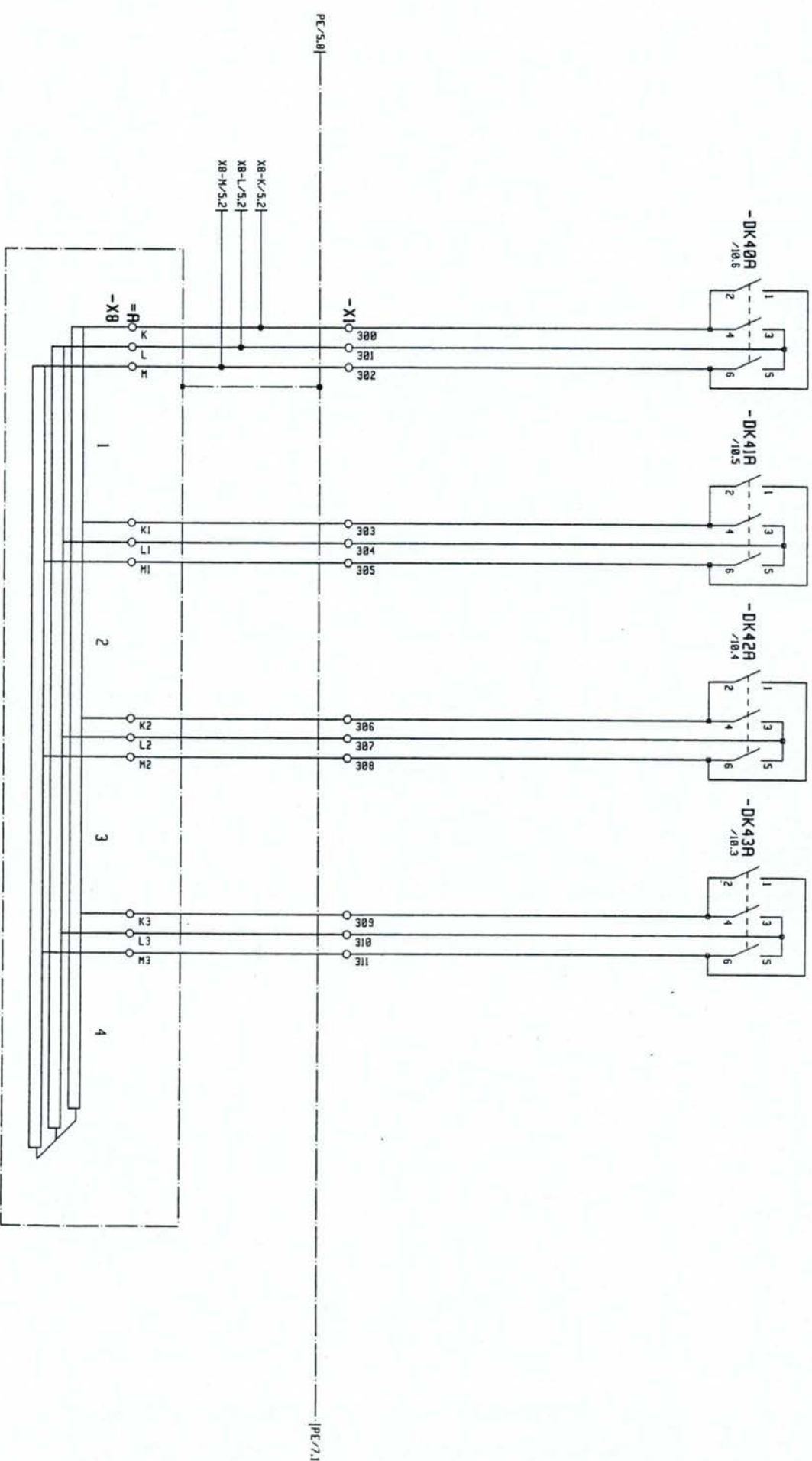

MIDRIM
32-WIDERSTANDSSCHRANK

3							TYPE			
2			Ges.	06.02.91	ELLINGER	LIEBHERR MERK	HC+ECH	=	SI	
1			Bearb.			BIBERACH		+ Blatt	6+	
			Änderung			Copyright Ici	27-DREHMERK			
			Datum							
			Name							

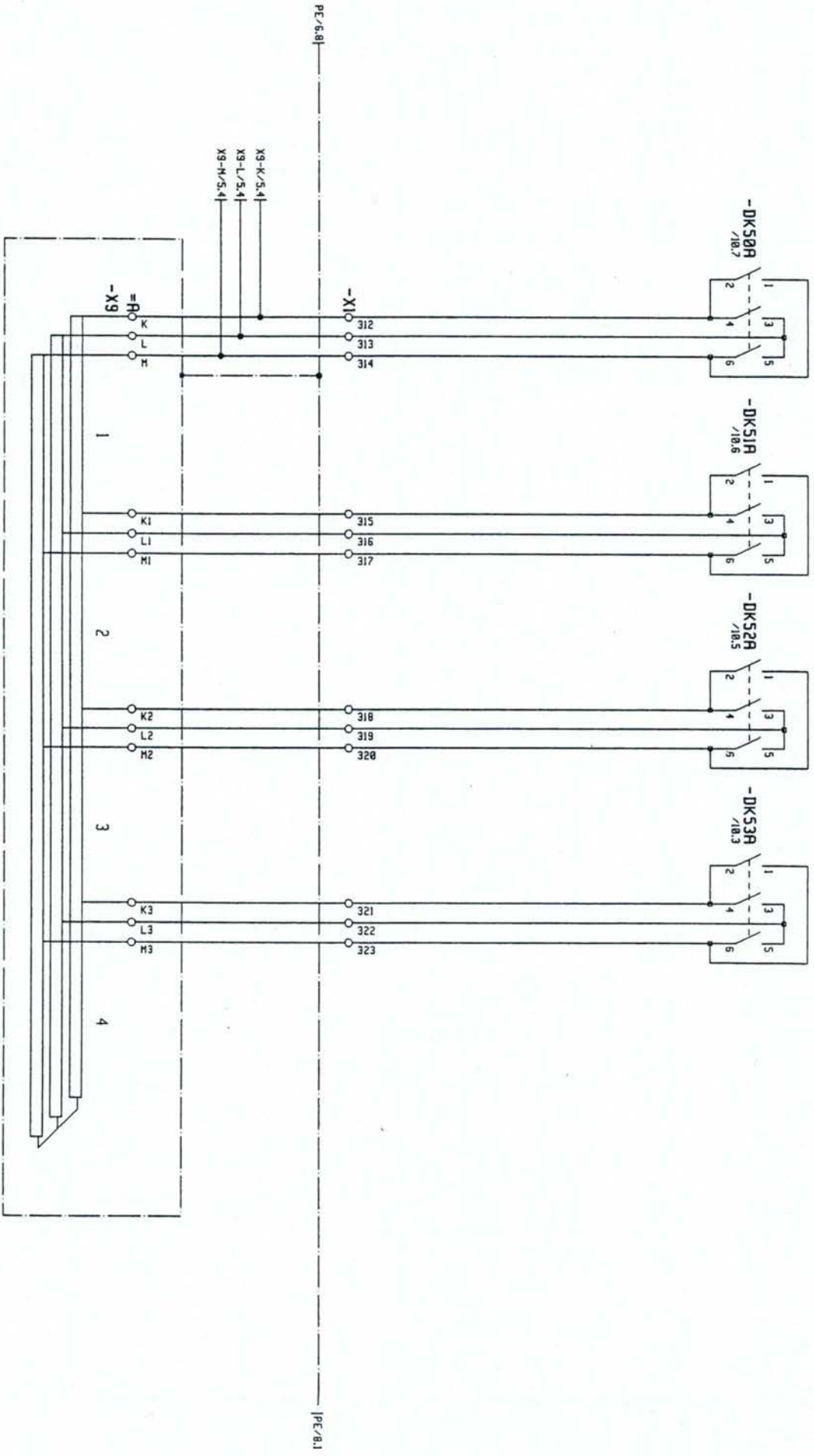

MIDR2M
32-WIDERSTANDSSCHRANK

3		Gez.	06.02.91		ELLINGER		LIEBHERR MERK		27-DREHMERK		TYPE		HC+ECH		-		SI	
2		Bearb.					BIBERACH				Zeich.-Nr.		4005-21439		+			
1		Änderung					Copyright (c)				Blatt		7+		+			
		Datum					Copyright (c)				Blatt		7+		+			
		Name					Copyright (c)				Blatt		7+		+			

2 3 4 5 6 7

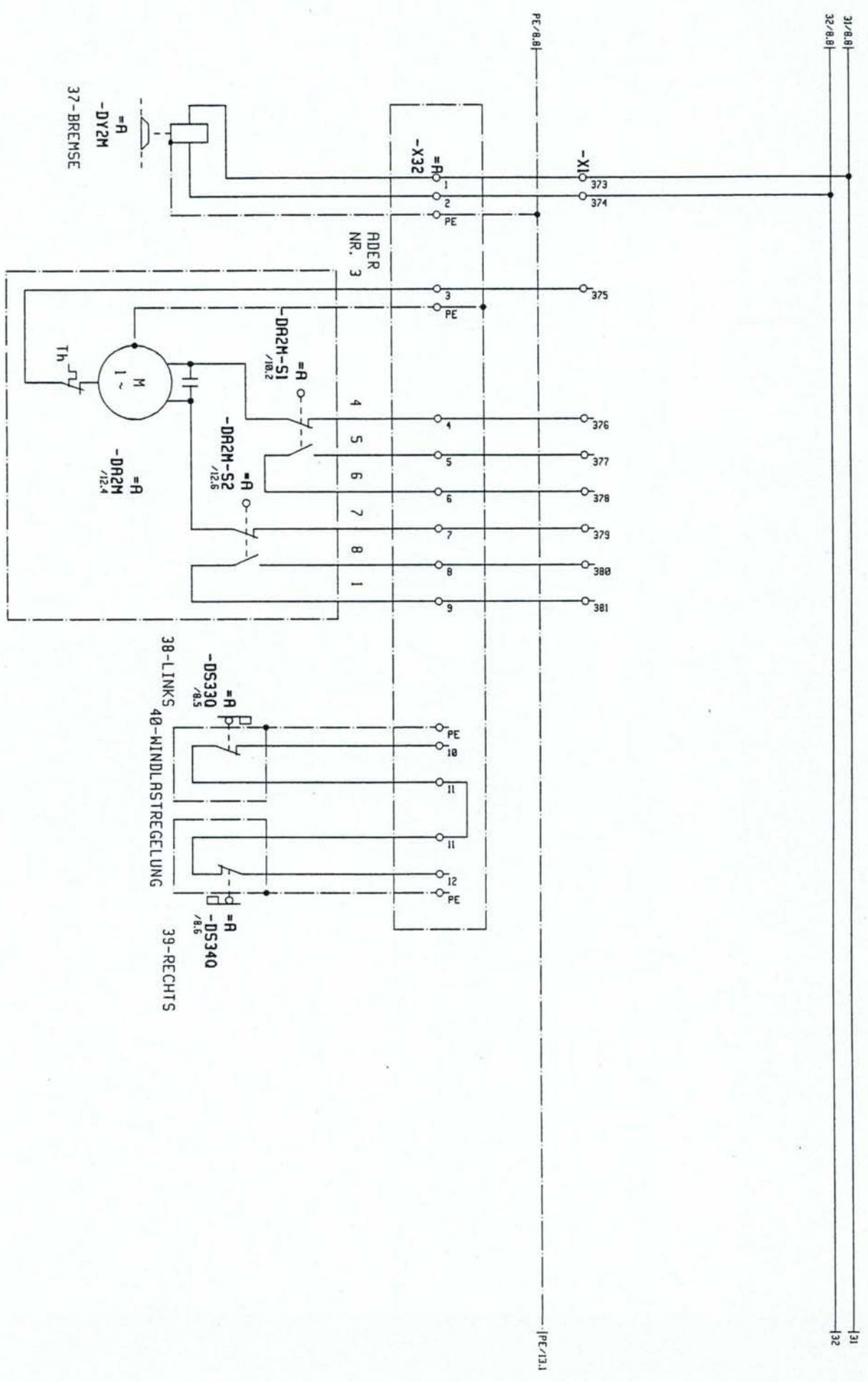

3				Gez.	06.02.91	ELLINGER			
2				Bearb.		LIEBHERR MERK			TYPE
1	Handlung	Datum	Name	Datum	Name	BIBERACH			HC+ECH
						Copyright (c)			4005-21439
									Blatt
									3+
									SI

R B C D E

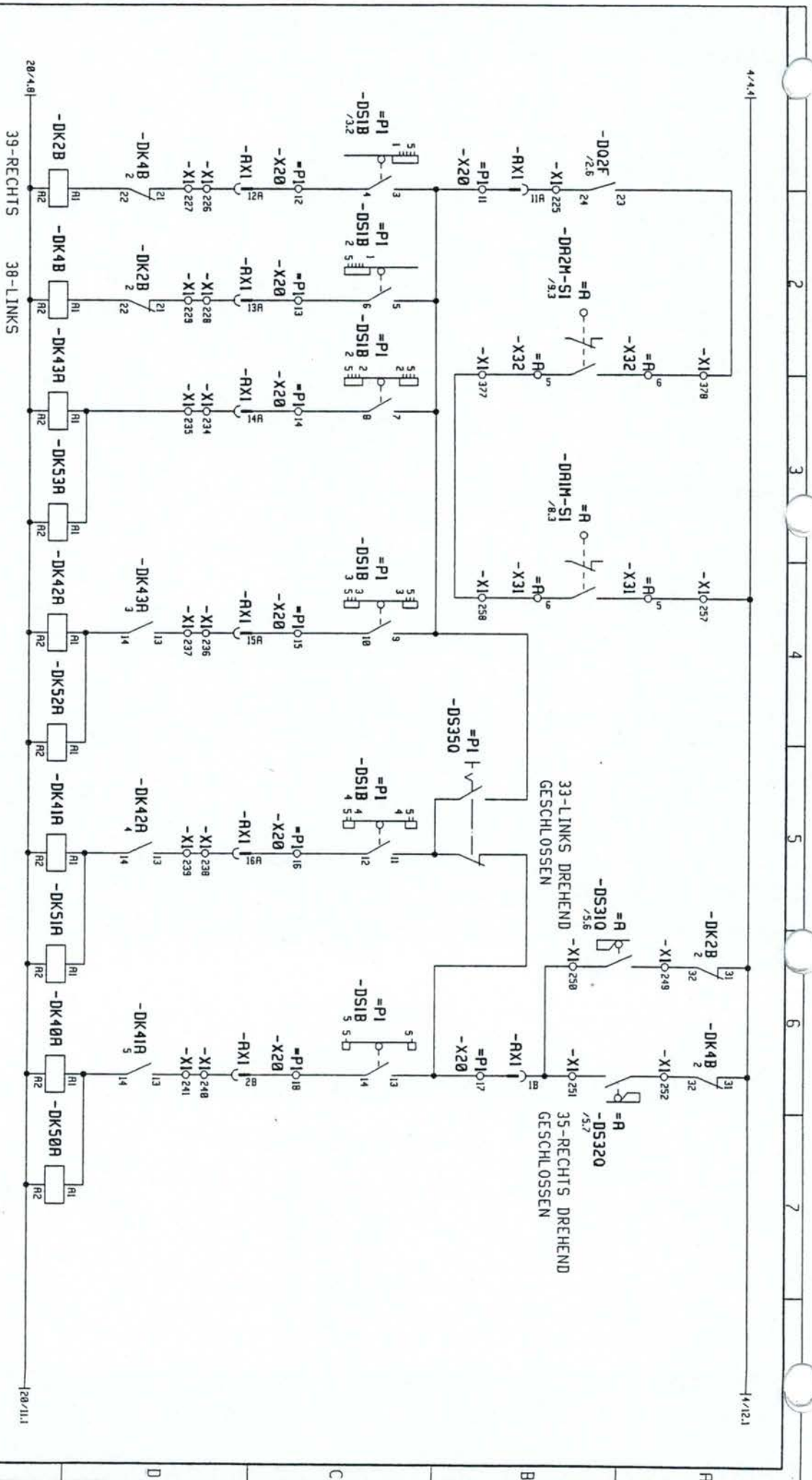

39-RECHTS		38-LINKS	
1	1	1	1
2	2	2	2
3	3	3	3
4	4	4	4
5	5	5	5
6	6	6	6
7	7	7	7
8	8	8	8
9	9	9	9
10	10	10	10
11	11	11	11
12	12	12	12
13	13	13	13
14	14	14	14

Änderung	Datum	Name	Bearb.	Datum	Name

Gen.	06.02.91	ELLINGER

LIEBHERR WERK		BIBERACH		27-DREHWERK	

TYPE	HC+ECH

Zieh-Nr.	4005-21439

SI	10+

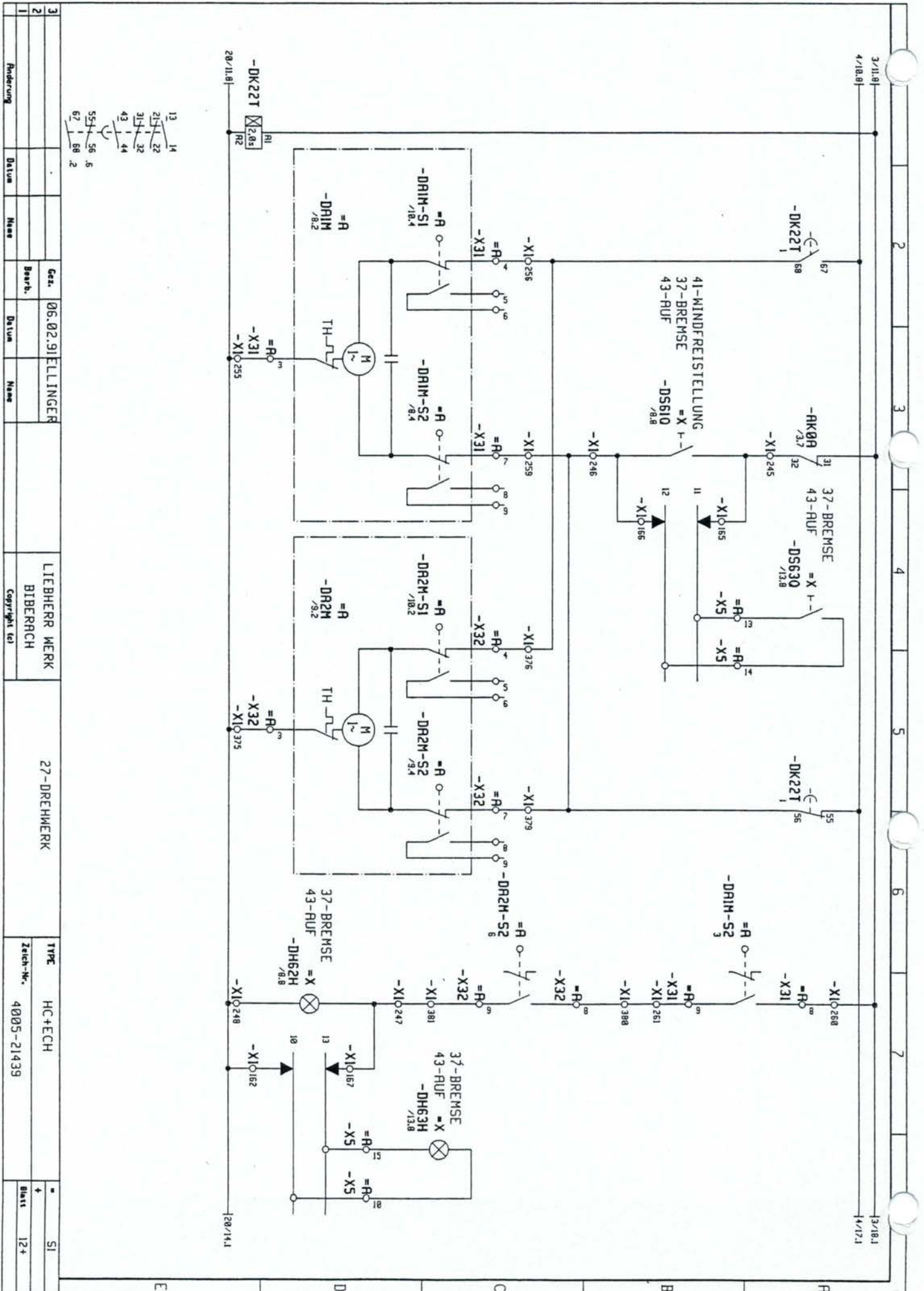

3/11.81 4/18.81 2 3 4 5 6 7 3/18.1 4/17.1

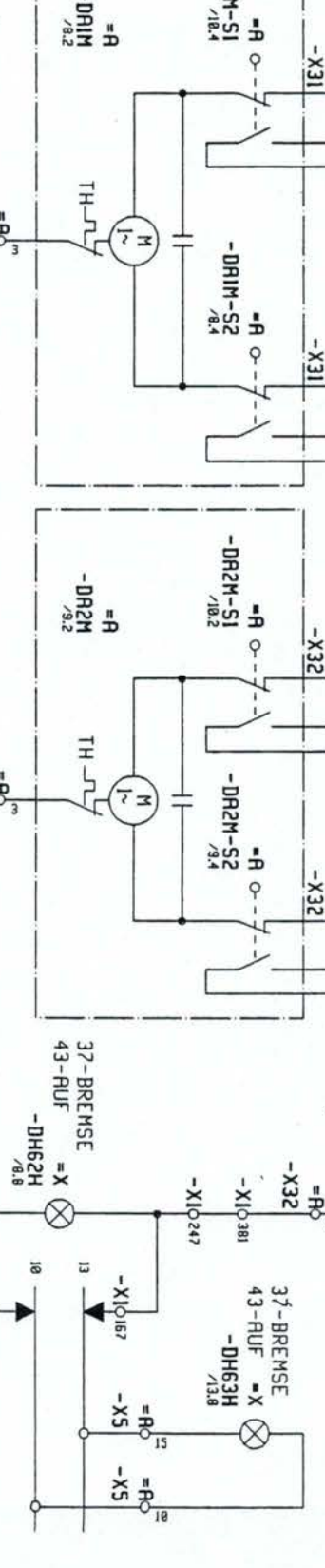
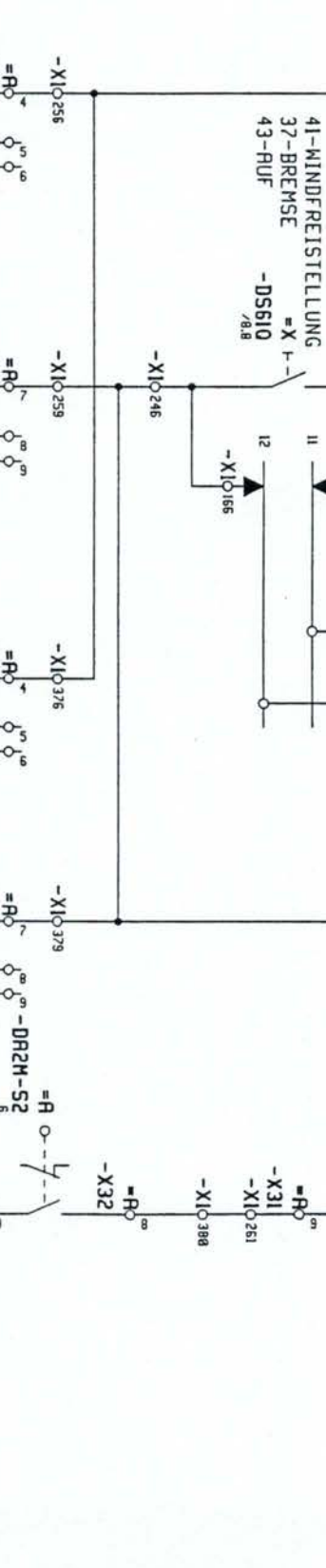
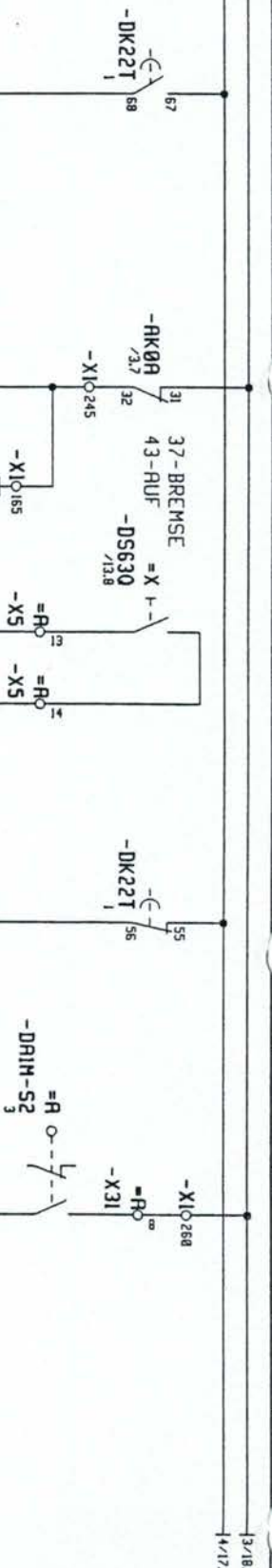

L4/5,8		L4/5,1
L5/5,8		L5/5,1
L6/5,8		L6/5,1
25/2,5		25/16,1
26/2,4		26/16,1

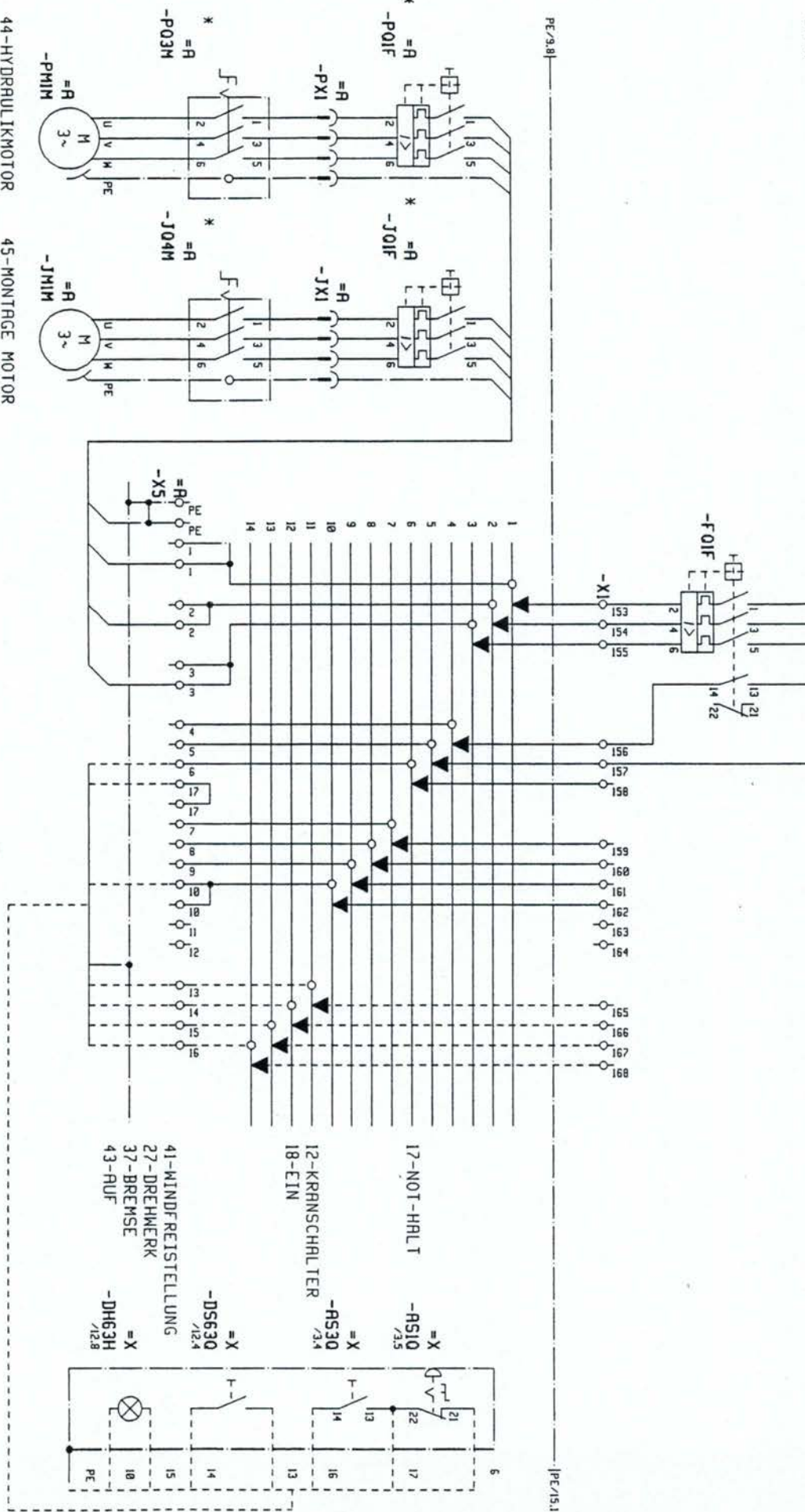

3	Gez.	06.02.91	ELLINGER
2	Bearb.		
1	Änderung	Datum	Name
		LIEBHERR WERK	
		BIBERACH	
		Copyright (c)	
		28-FRHRWERK	
TYPE	HC+ECH		
Zeich.-Nr.	4005-21439		
		SI	
	Blatt	13+	

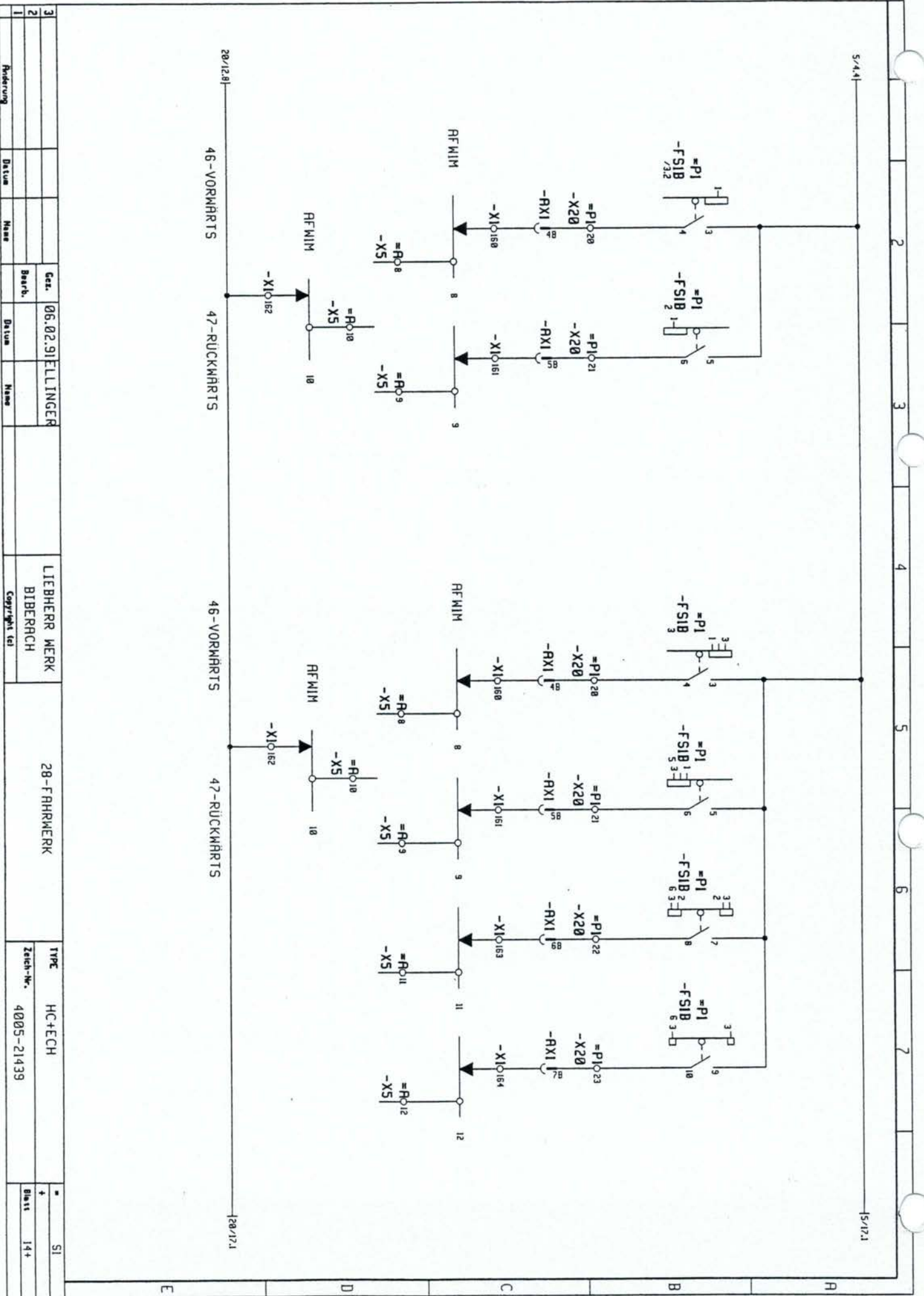

3				Ger.	06.02.91		HELLINGER				
2				Bearb.			LIEBHERR WERK BIBERACH				
1				Datum			Copyright Ica				
1	Änderung			Datum	Name		28-FHRWERK				
			Typ	HC+ECH		Zeich.-Nr.		4005-21439			
			Blatt	14+		SI					

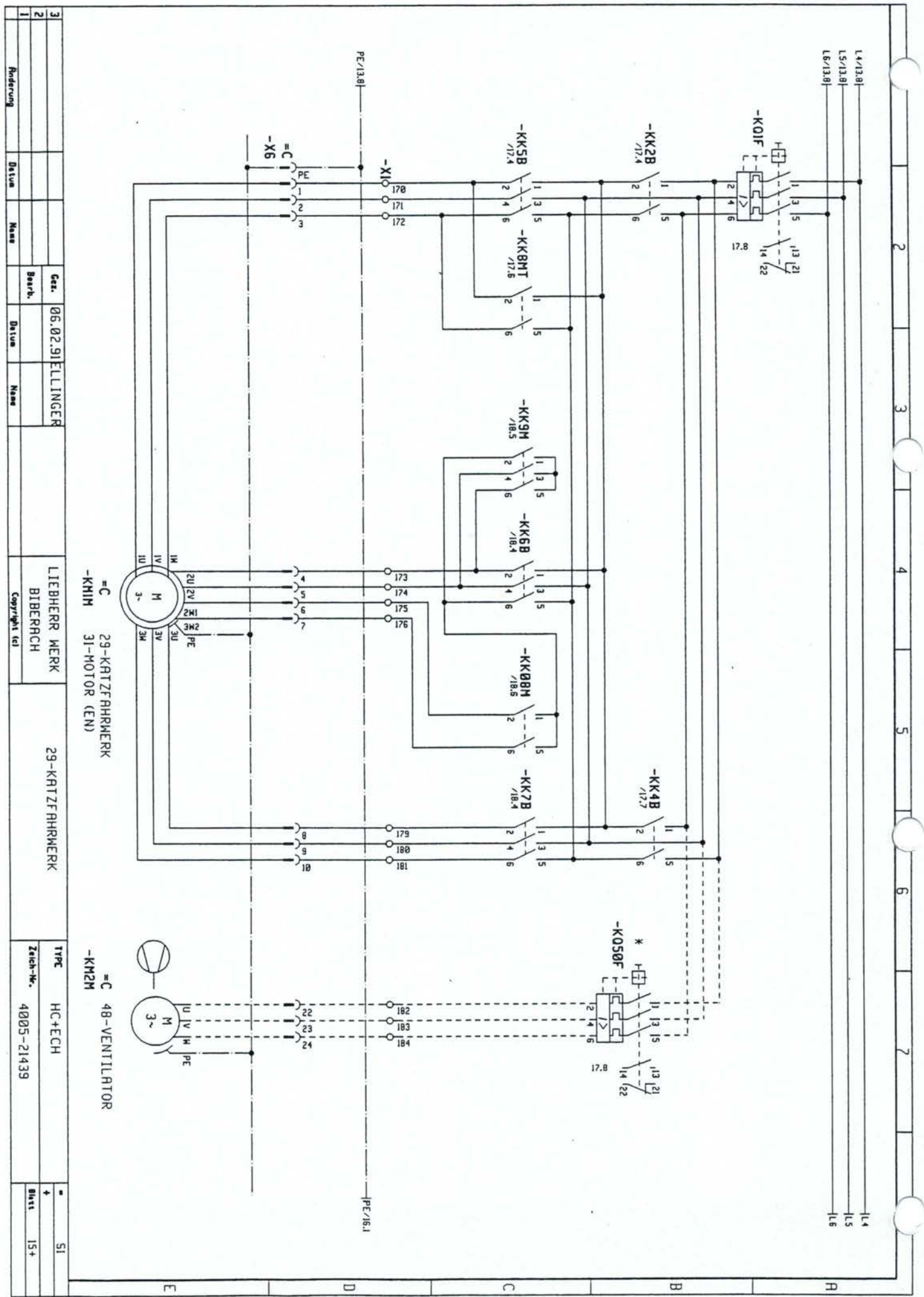

3			Ger.	06.02.91 ELLINGER		LIEBHERR MERK BIBERACH		29-KATZFHRRWERK	TYPE	HC+ECH	
2			Bearb.			Copyright tel			Zeich.-Nr.	4005-21439	
1			Änderung		Datum		Name				

=C
 29-KATZFHRRWERK
 -KM1H
 31-MOTOR (EN)

=C
 48-VENTILATOR
 -KM2H

L4/13.8
 L5/13.8
 L6/13.8
 L1.4
 L1.5
 L1.6

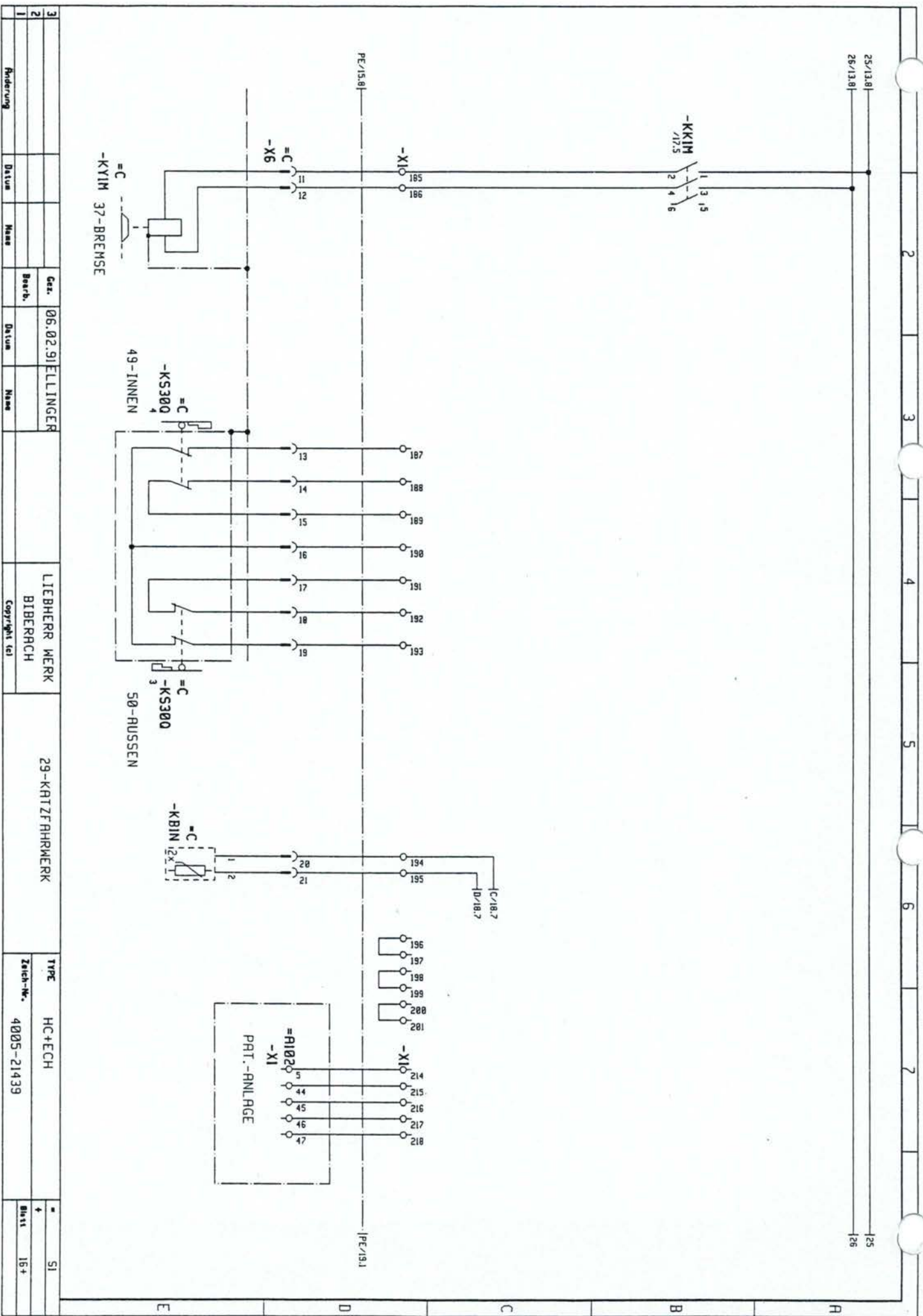

3					Ger.	06.02.91	ELLINGER	LIEBHERR MERK BIBERACH		29-KRITZFHRWERK	TYPE	HC+ECH	SI	
2				Bearb.				Copyright (c)			Zeich-Nr.	4005-21439		
1				Änderung	Datum	Neue							Blatt	15+

F
B
C
D
E

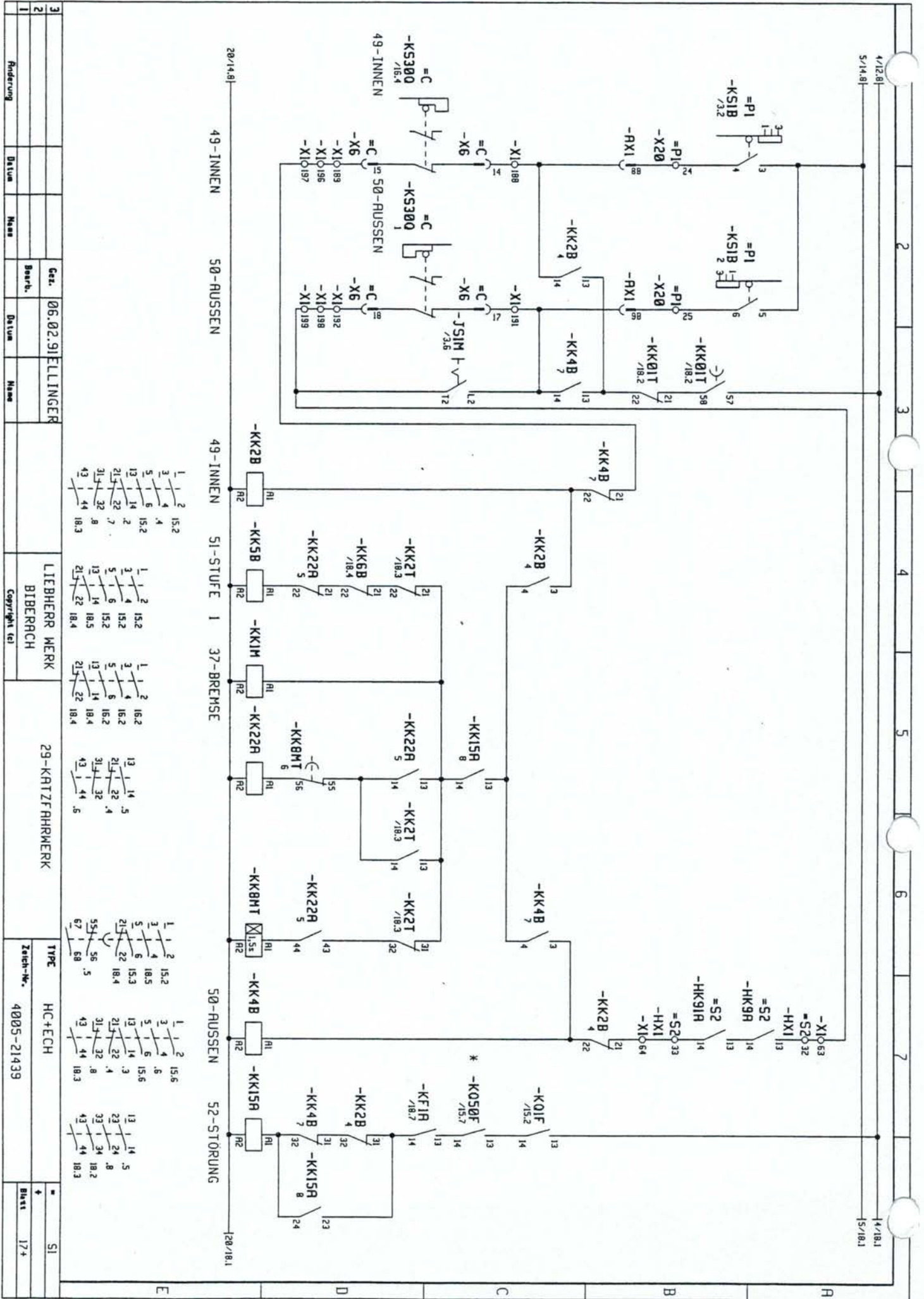

1	Anderung	Datum	Name	Gez.	06.02.91	FELLINGER	LIEBHERR MERK	29-KRITZFRHRWERK	HC+ECH	4005-21439	SI
2				Boarb.			BIBERACH				+
3				Datum			Copyright (c)				Bisst
											17+

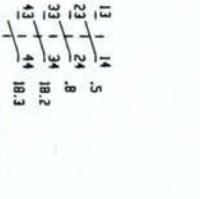

R 4/12.81 5/14.81 14/18.1

2 3 4 5 6 7

20/14.81 49-INNEN 50-RUSSEN 49-INNEN 51-STUFE 1 37-BREMSE 50-RUSSEN 52-STÖRUNG 120/18.1

E

D

C

B

R

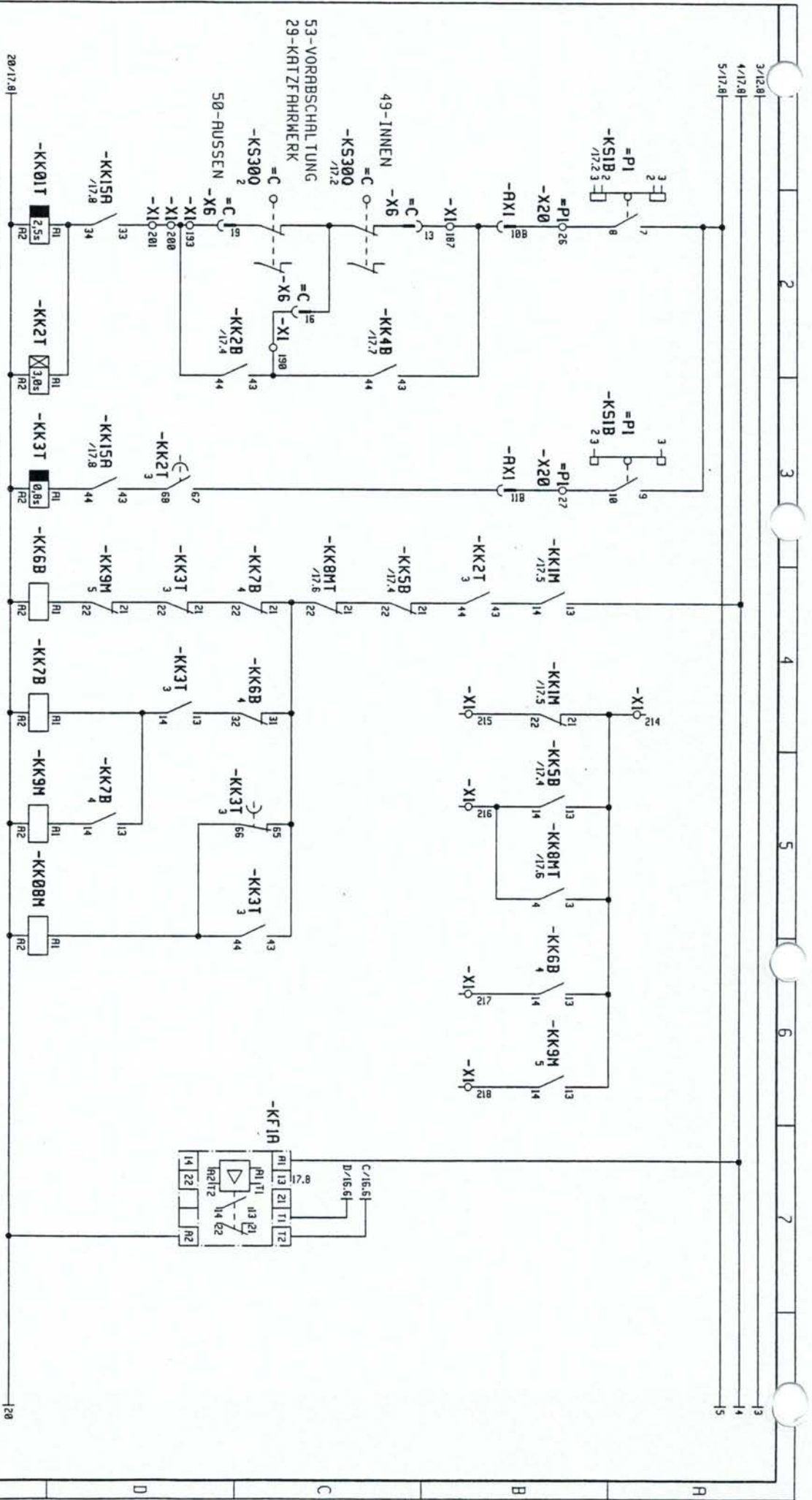

3	Änderung	Datum	Name	Ger.	06.02.91	ELLINGER	LIEBHERR MERK	29-KATZFRHRWERK	TPC	HC+ECH	+	SI
2				Bearb.			BIBERACH		Zeich.-Nr.	4005-21439	+	18+
1												

13	14	13	14
21	32	21	32
31	32	31	32
43	44	43	44
57	58	57	58
65	66	65	66

13	14	13	14
21	22	21	22
31	32	31	32
43	44	43	44
57	58	57	58
67	68	67	68

1	2	1	2
3	4	3	4
5	6	5	6
13	14	13	14
15	16	15	16

1	2	1	2
3	4	3	4
5	6	5	6
13	14	13	14
15	16	15	16

1	2	1	2
3	4	3	4
5	6	5	6
13	14	13	14
15	16	15	16

1	2	1	2
3	4	3	4
5	6	5	6
13	14	13	14
15	16	15	16

1	2	1	2
3	4	3	4
5	6	5	6
13	14	13	14
15	16	15	16

1	2	1	2
3	4	3	4
5	6	5	6
13	14	13	14
15	16	15	16

1	2	1	2
3	4	3	4
5	6	5	6
13	14	13	14
15	16	15	16

1	2	1	2
3	4	3	4
5	6	5	6
13	14	13	14
15	16	15	16

BEI 2
 62-GANG
 65-HUBWERKGETRIEBE
 23-ÜBERBRÜCKEN

14-SCHULTSCHIRANK S2
 30-HUBWERK

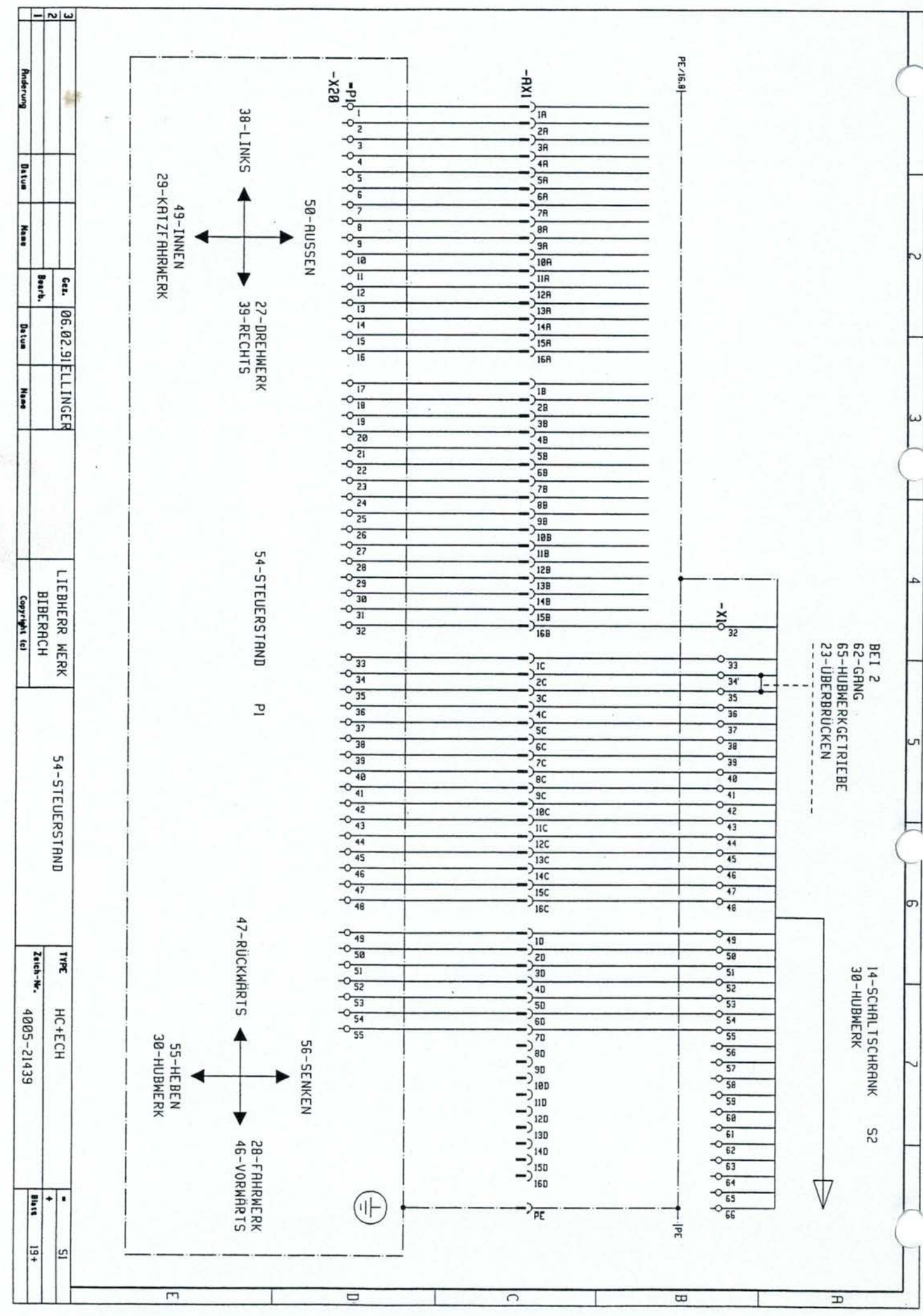

3			Gez. 06.02.91 ELLINGER		LIEBHERR WERK BIBERACH		54-STEUERSTAND		TYPE HC+ECH	SI
2			Bezch.		Copyright (c)				Zersch-Nr. 4005-21439	+
1	Änderung		Datum		Name		Datum		Blatt 19+	

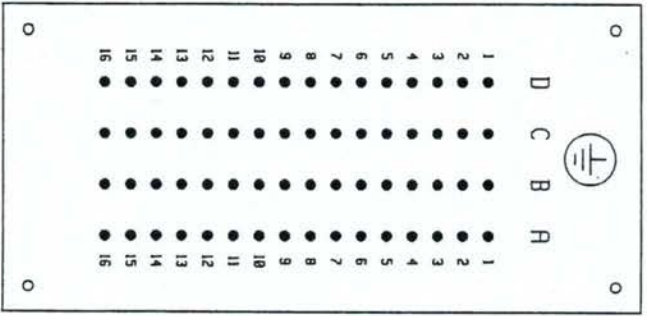

sti

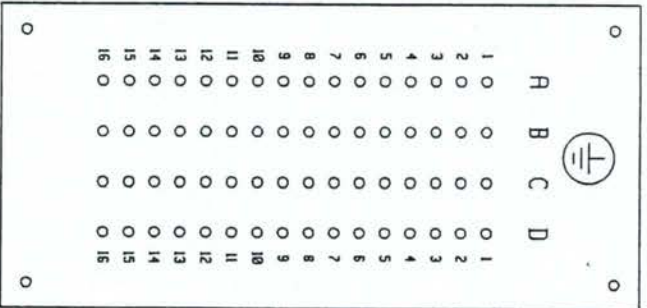

bu

57-RNSICHT ANSCHLUBSEITE

3				Gen.	06.02.91	ELLINGER	LIEBHERR WERK	54-STECKVERBINDER	TYPE	HC+ECH	-	SI
2				Bearb.			BIBERACH		Zeich.-Nr.	4005-21439	+	
1					Datum		Copyright (c)					Bits 20-
	Änderung	Datum	Name									

A B C D E

