

3	Enderung				
2		Gez.	21.06.90 ELLINGER	Name	
1		Datum	Bearb.	Name	

LIEBHERR MERK  
 BIBERACH  
 Copyright (c)

11-EINSPEISUNG  
 TYPE EC  
 Zeich.-Nr. 40 05 21434

SI  
 +  
 Blatt 1+

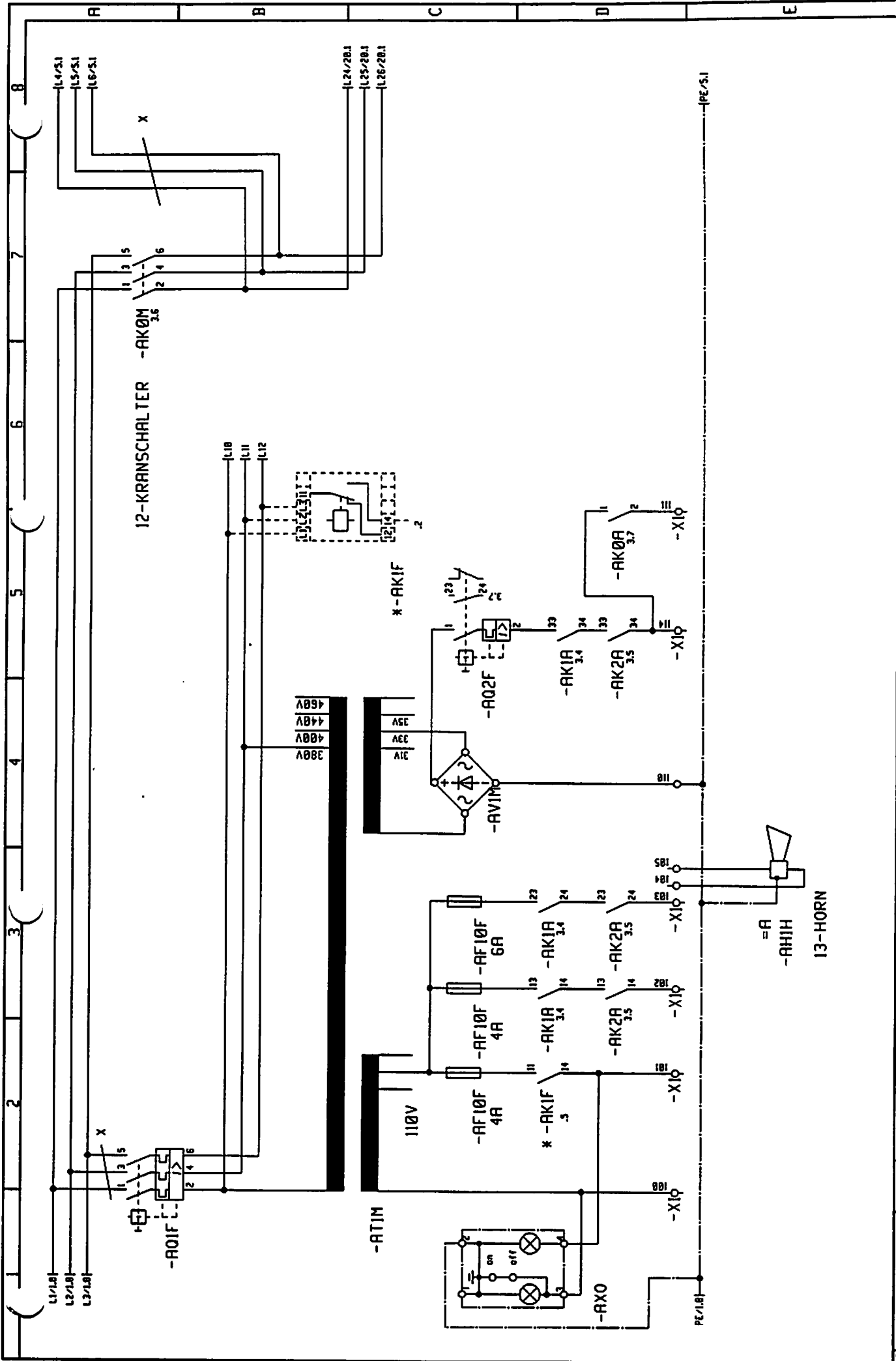

3					18.06.90 ELLINGER		LIEBHERR MERK BIBERACH		16-STEUERUNG		TYPE EC		SI	
2			Ges.		Bearb.		Name		Date		Name		Blatt	
1	Änderung		Datum		Datum		Name		Date		Name		2+	
													Zeich.-Nr.	40 05 21434





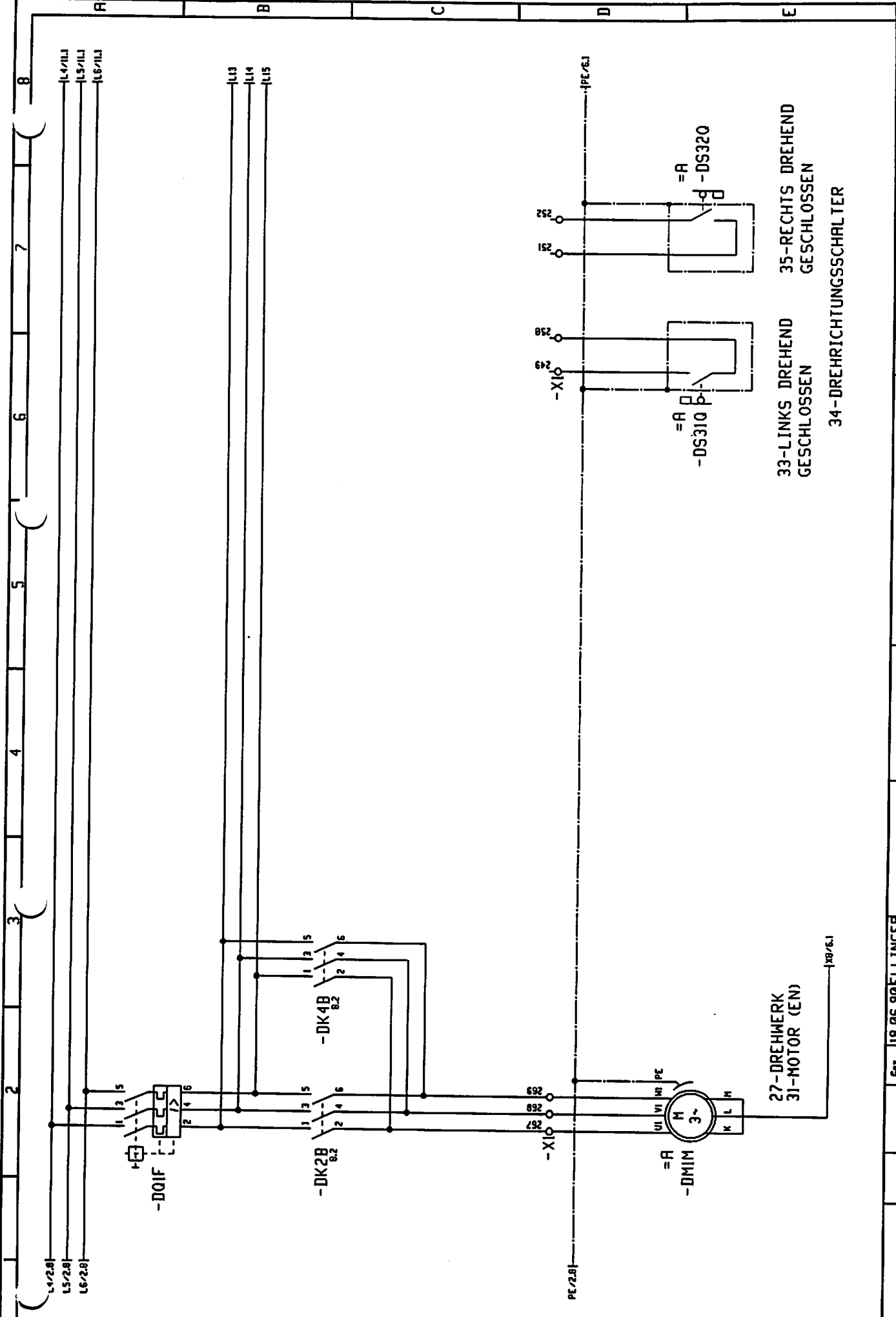

**33-LINKS DREHEND  
GESCHLOSSEN**  
**35-RECHTS DREHEND  
GESCHLOSSEN**  
**34-DREHRICHTUNGSSCHALTER**

3	Gest. 18.06.90		ELLINGER		27-DREHWERK	TYPE EC	= SI
	Bearb.	Datum	Name	Riese			
2							+
1							Blatt 5+

Zeich-Nr. 40 05 21434

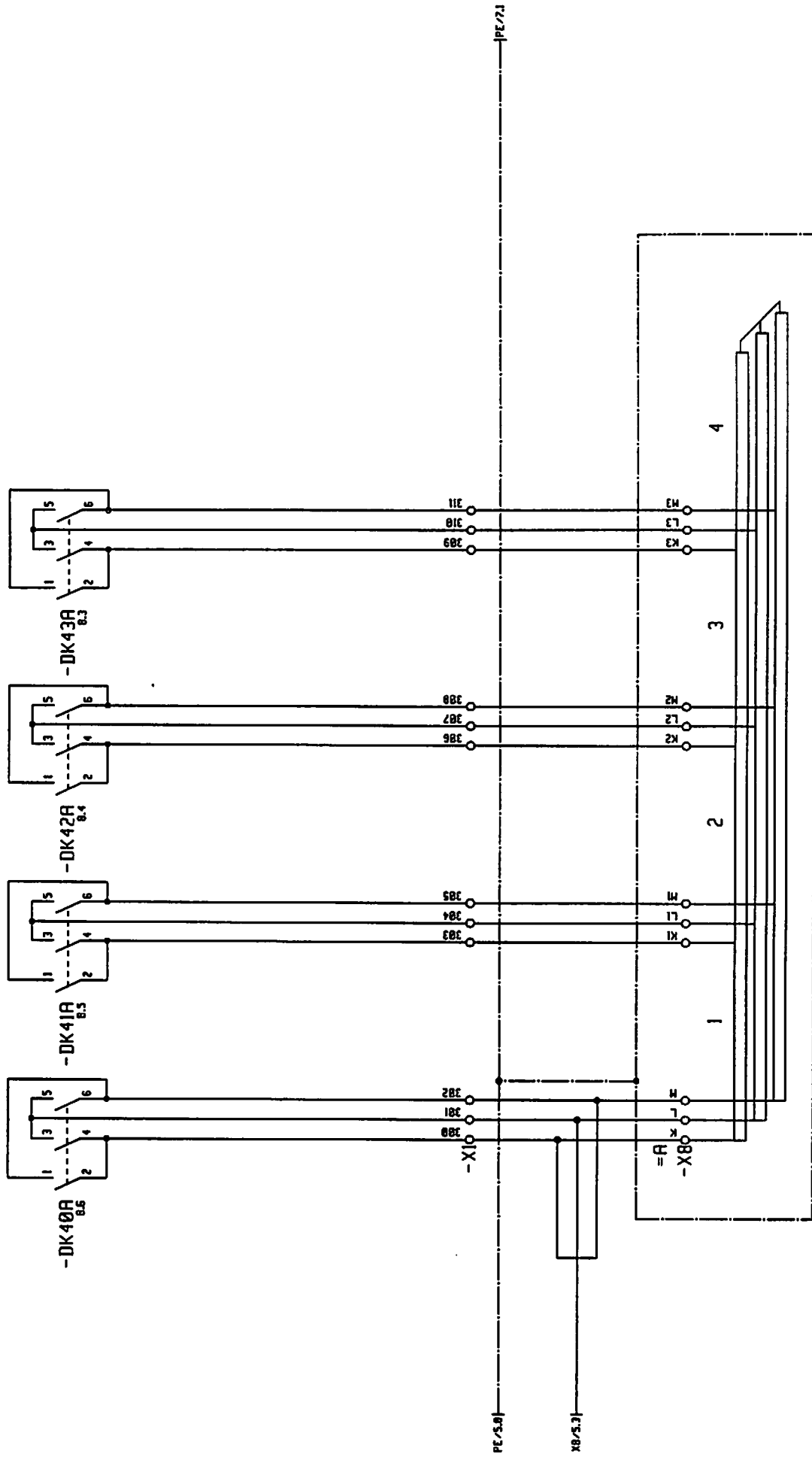

WIDRIM  
32-WIDERSTANDSSCHRANK

3	Gez.	18.06.90	ELLINGER
2	Bearb.		
1	Name	Datum	Name

LIEBHERR WERK  
BIBERACH  
Copyright ©

27-DREHWERK

TYPE EC

Zeich.-Nr. 40 05 21434

+ Blatt

SI 6+

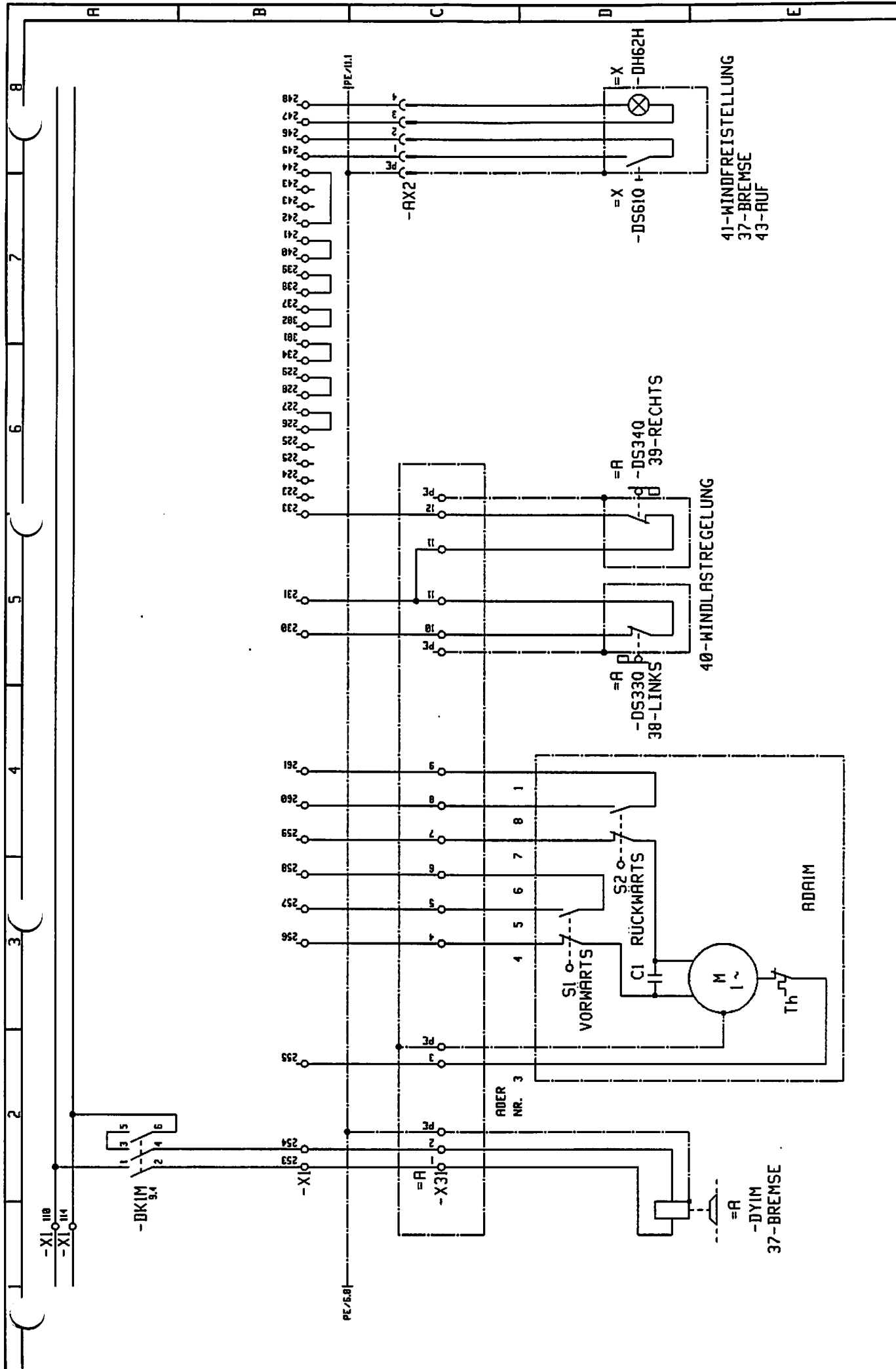

3	Gez.	18.06.90	ELLINGER	Name		TYPE	EC	-	SI
2	Besch.			Datum				+	
1	Änderung	Datum	Name			Zeich.-Nr. 40 05 21434		Blatt	7+

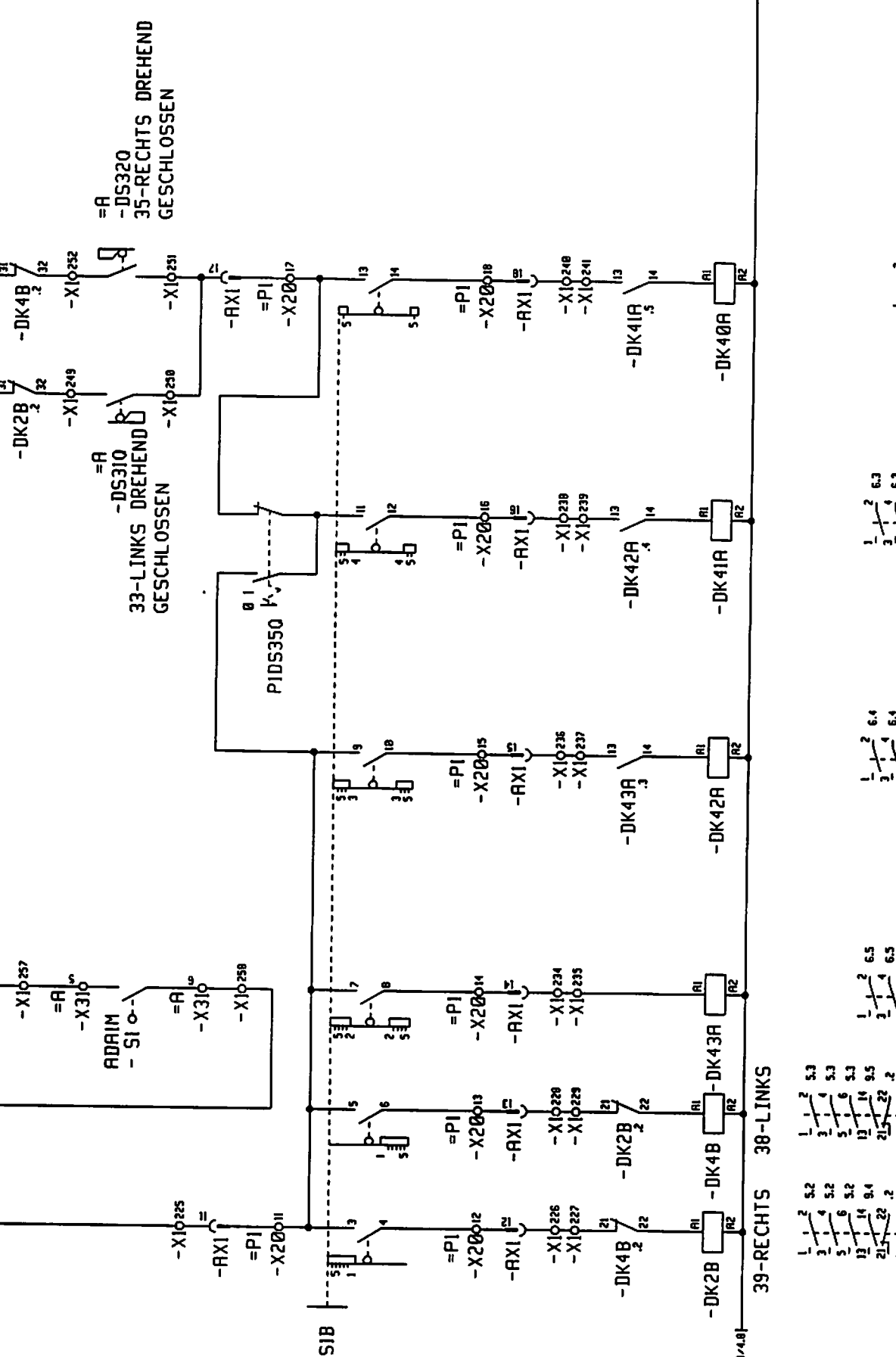

ADAIM  
-S1 o-  
=R  
-X310<sup>5</sup>  
-X10257

-DK2B  
=R  
-DS310  
33-LINKS DREHEND  
GESCHLOSSEN

-DK4B  
=R  
-DS320  
35-RECHTS DREHEND  
GESCHLOSSEN

PIDS350

-X10235  
-AX1  
=PI  
-X2011

-X10225  
-AX1  
=PI  
-X2012

-X10226  
-X10227  
-DK4B  
=R1  
-DK2B  
=R1  
-DK4B  
=R1  
-DK43A  
=R1  
-DK43A  
=R1  
-DK42A  
=R1  
-DK42A  
=R1  
-DK41A  
=R1  
-DK41A  
=R1  
-DK40A  
=R1

-X10238  
-AX1  
=PI  
-X2015  
-X10235  
-X10237  
-X10239  
-AX1  
=PI  
-X2016  
-X10238  
-X10239

-X10248  
-AX1  
=PI  
-X2018  
-X10241  
-DK41A  
=R1  
-DK41A  
=R1

- |    |    |     |     |
|----|----|-----|-----|
| 1  | 1  | 2   | 5.2 |
| 2  | 2  | 4   | 5.2 |
| 3  | 3  | 6   | 5.2 |
| 4  | 4  | 8.4 | 5.2 |
| 5  | 5  | 14  | 9.5 |
| 6  | 6  | 14  | 9.5 |
| 7  | 7  | 22  | 2   |
| 8  | 8  | 22  | 2   |
| 9  | 9  | 32  | .6  |
| 10 | 10 | 32  | .6  |
| 11 | 11 | 44  | 9.5 |
| 12 | 12 | 44  | 9.5 |

- |   |   |    |     |
|---|---|----|-----|
| 1 | 1 | 2  | 6.4 |
| 2 | 2 | 4  | 6.4 |
| 3 | 3 | 6  | 6.4 |
| 4 | 4 | 14 | .5  |
| 5 | 5 | 14 | .5  |
| 6 | 6 | 14 | .5  |
| 7 | 7 | 14 | .5  |
| 8 | 8 | 14 | .5  |

- |   |   |    |     |
|---|---|----|-----|
| 1 | 1 | 2  | 6.2 |
| 2 | 2 | 4  | 6.2 |
| 3 | 3 | 6  | 6.2 |
| 4 | 4 | 14 | .6  |
| 5 | 5 | 14 | .6  |
| 6 | 6 | 14 | .6  |
| 7 | 7 | 14 | .6  |
| 8 | 8 | 14 | .6  |

3		Gez.	18.06.90 FELLINGER										
2		Best.											
1		Datum											
		Name											
LIEBHERR MERK BIBERRACH										27-DREHWERK		EC	
										Zeich.-Nr.		40 05 21434	
										Blatt		8+	
										Copyright (c)			



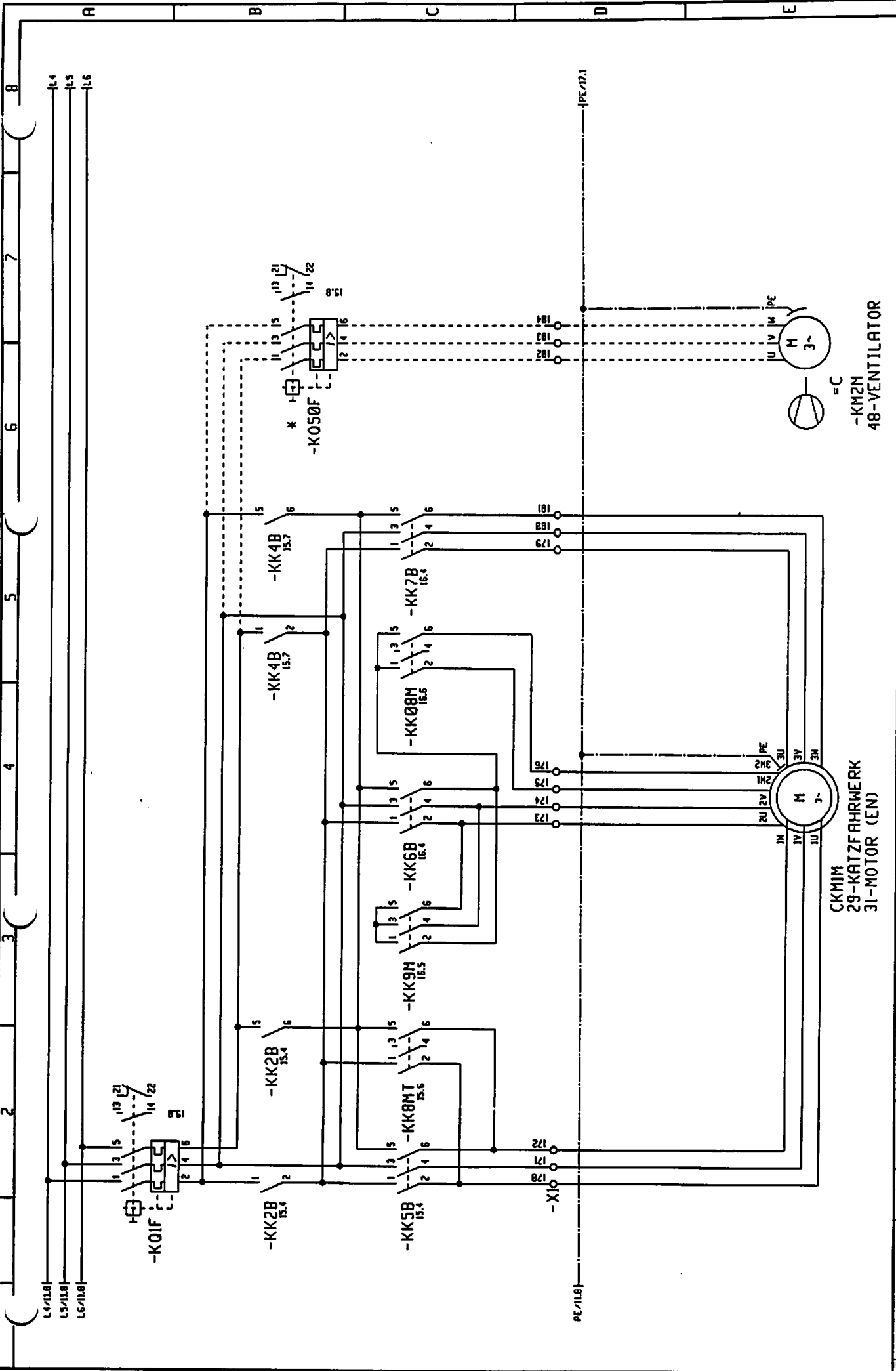

	Gen.	18.06.90	ELLINGER				
	Bearb.						
	Änderung	Datum	Name	Datum	Name	Datum	Name
	LIEBHERR MERK BIBERACH (Copyright G.)			29-KATZFÄHRWERK			TYPE EC
				Zetsch-Nr. 40 05 21434			SI
							+ Blatt 13+

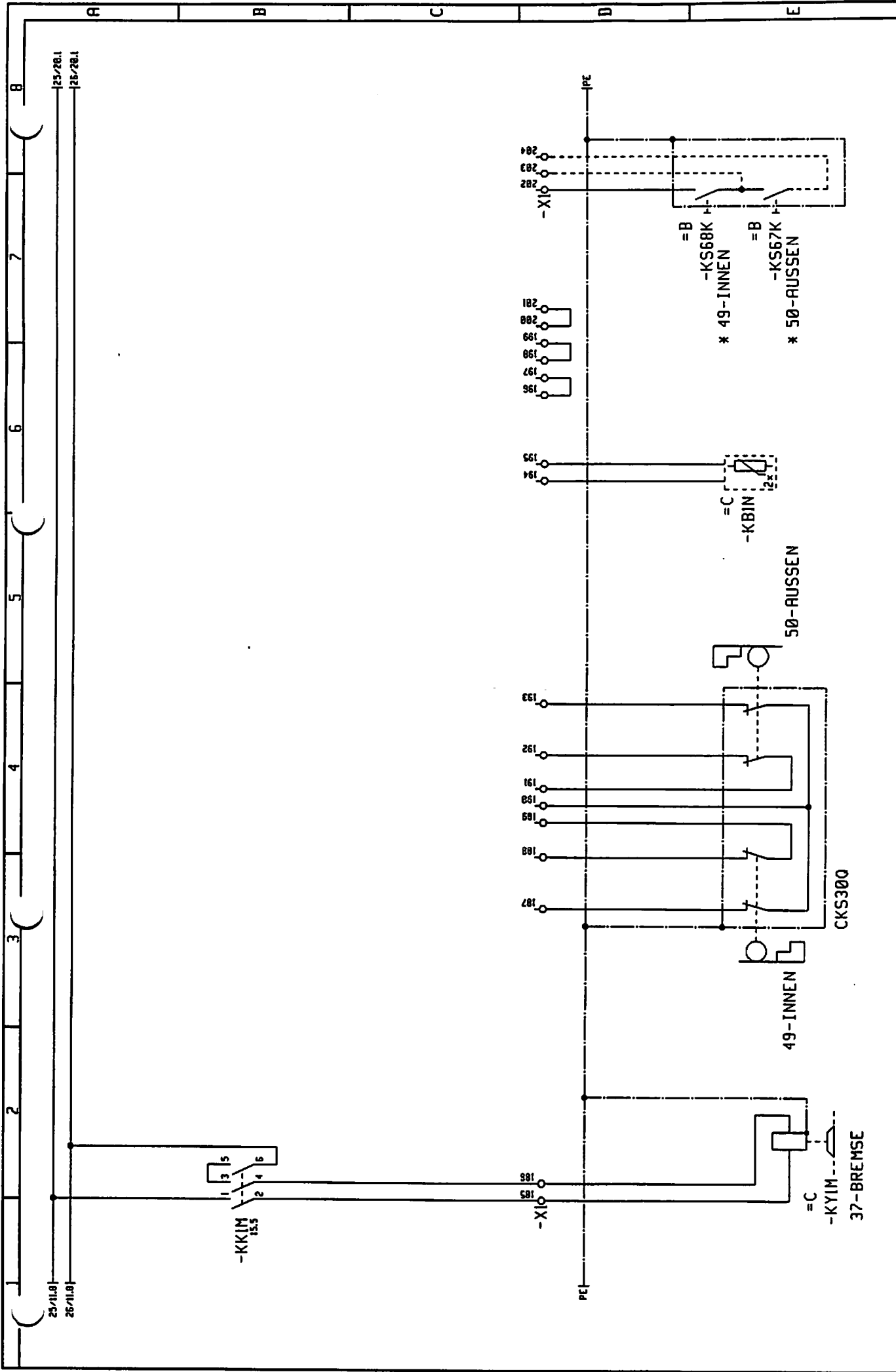

2	Änderung		Datum		Name
1	Gez.	18.06.50	ELL INGER		
2	Bearb.		Datum	Name	
3					

LIEBHERR MERK BIBERACH Copyright (c)	29-KATZFAHRWERK	TYPE EC	SI
Zeich.-Nr. 40 05 21434			Blatt 14+

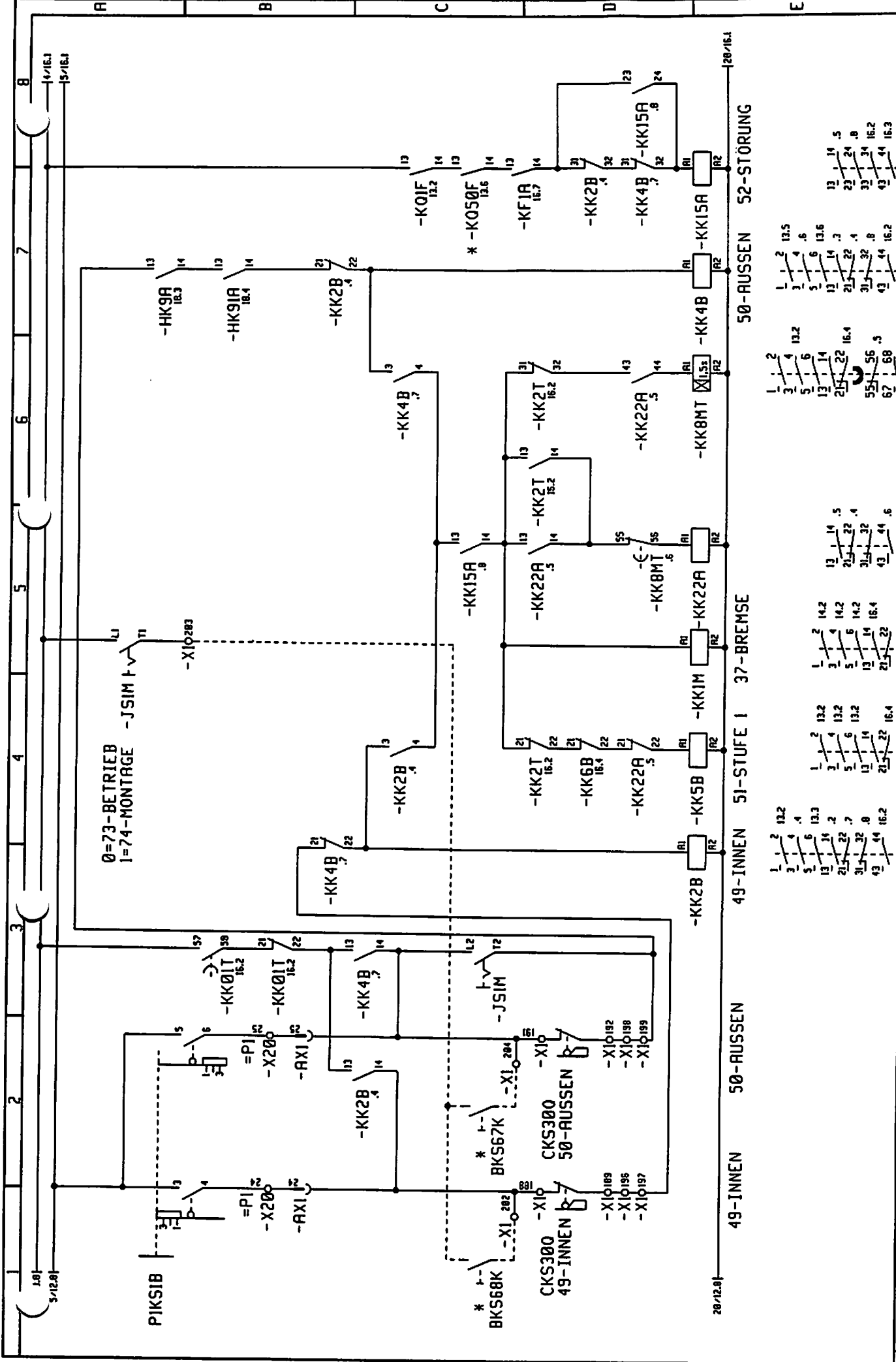

TYPE	EC
1 1 2 13.5	1 1 2 13.5
3 1 4 13.2	3 1 4 13.2
5 1 6 13.6	5 1 6 13.6
13 1 14 13.3	13 1 14 13.3
21 1 22 16.4	21 1 22 16.4
31 1 32 16.2	31 1 32 16.2
43 1 44 16.2	43 1 44 16.2
55 1 56 16.2	55 1 56 16.2
67 1 68 16.2	67 1 68 16.2

Änderung		Gez.		18.06.90 FELLINGER		LIEBHERR MERK		29-KATZFÄHRWERK		TYPE		EC		SI	
Nr.	Datum	Nr.	Datum			BIBERACH				Zeich.-Nr.		Blatt		15+	
3						Geführte G				40 05 21434		Blatt		15+	



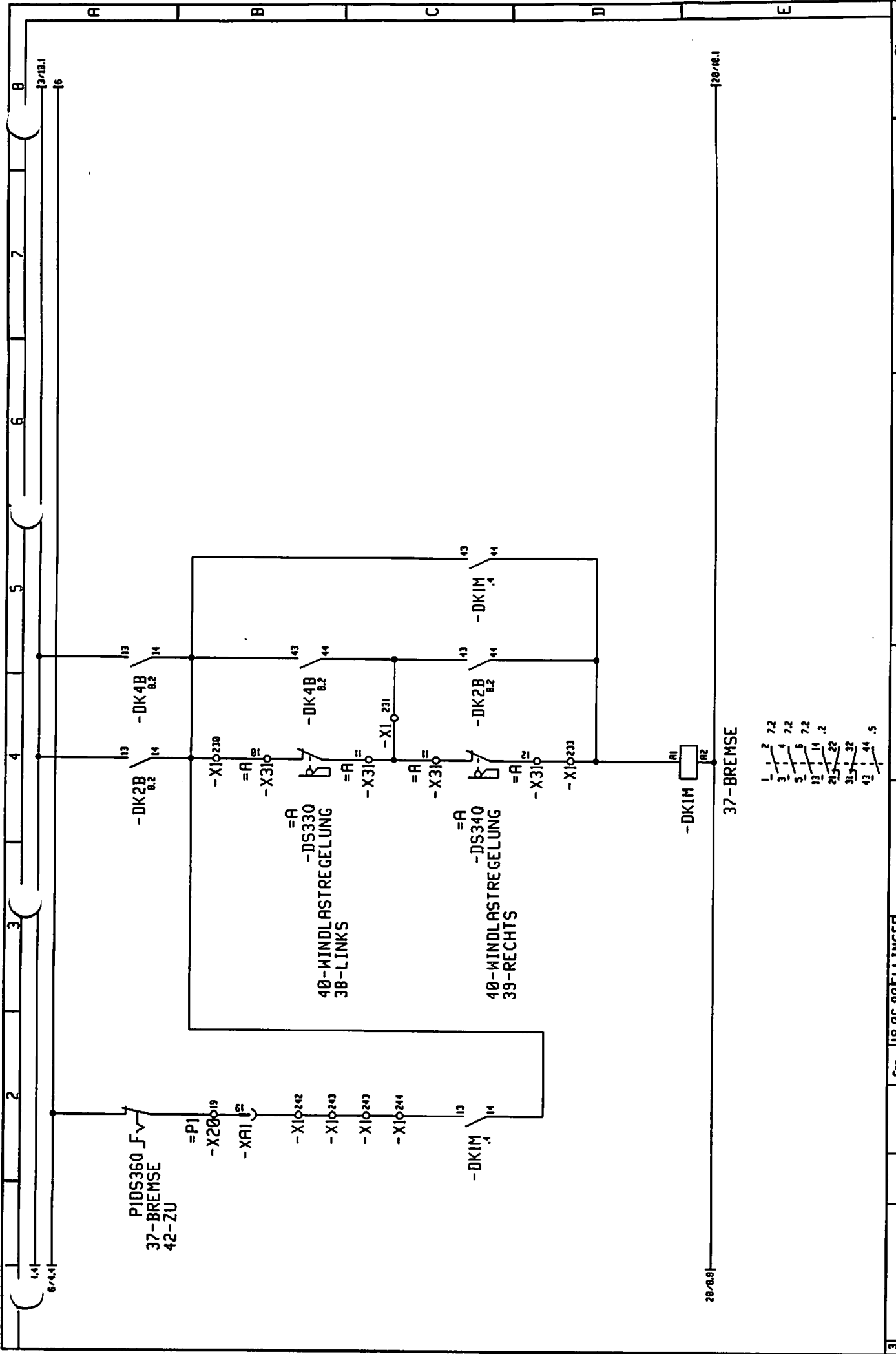

Terminal connection table:

1	1	2	7.2
2	3	4	7.2
3	5	6	7.2
4	13	14	2
5	21	22	2
6	31	32	2
7	43	44	5

3			Gesz.	18.06.90	EELLINGER		LIEBHERR MERK BIBERRACH <small>Copyright ©</small>		27-DREHWERK	TYPE	EC	Zeich.-Nr. 40 05 21434	Blatt	9+
2			Beauf.											
1			Name											

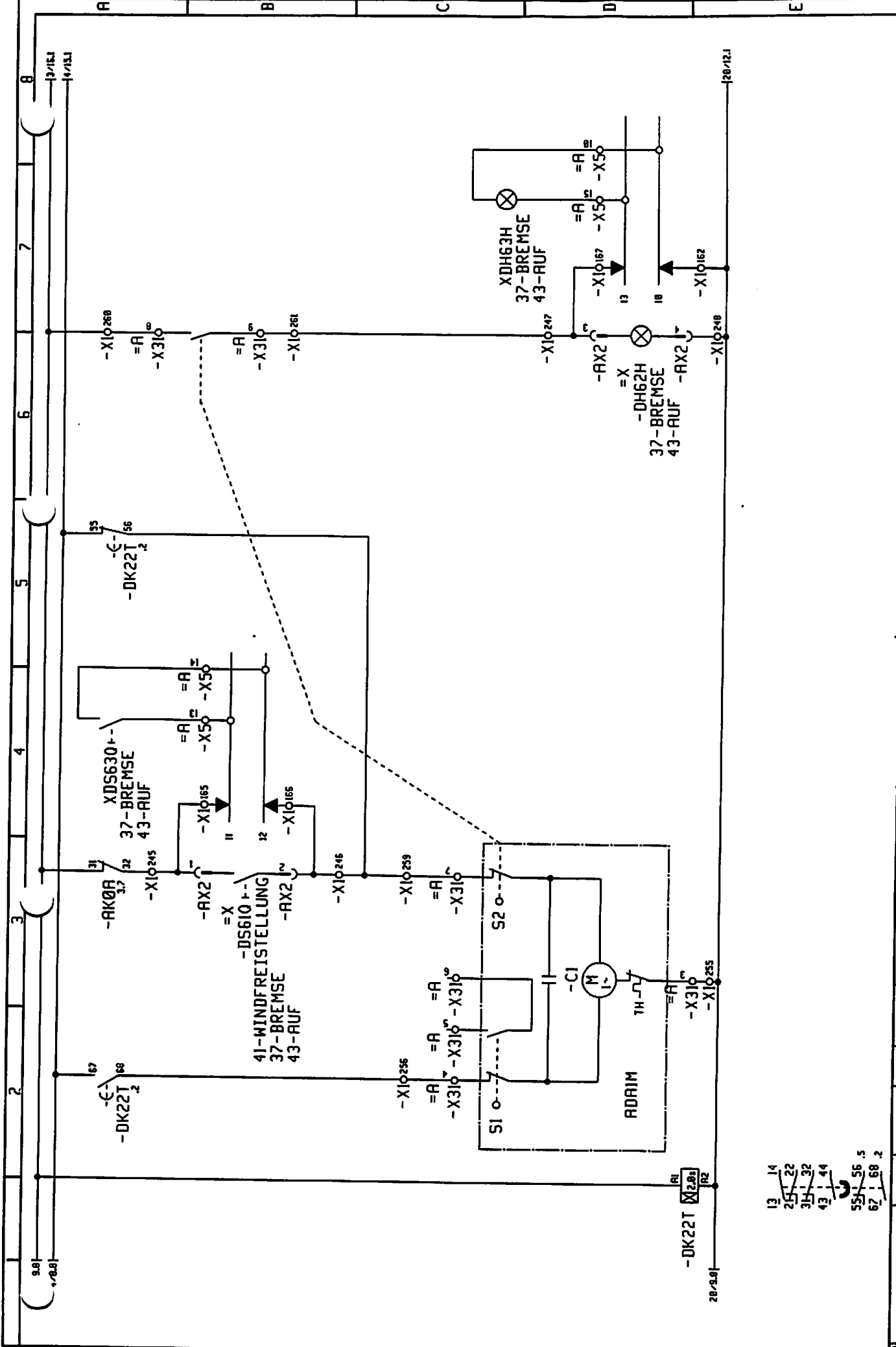

- 13 | 14
- 25 | 22
- 34 | 32
- 43 | 44
- 55 | 56.5
- 67 | 68.2

31	Gen.	18.06.90	ELLINGER					TYPE	EC	SI
2	Bearb.							Zersch.-Nr.	40 05 21434	Blatt
1	Name									10+
	Änderung	Datum	Name	Datum	Name	LIEBHERR MERK BIBERACH Copyright ©				
						27-DREHWERK				







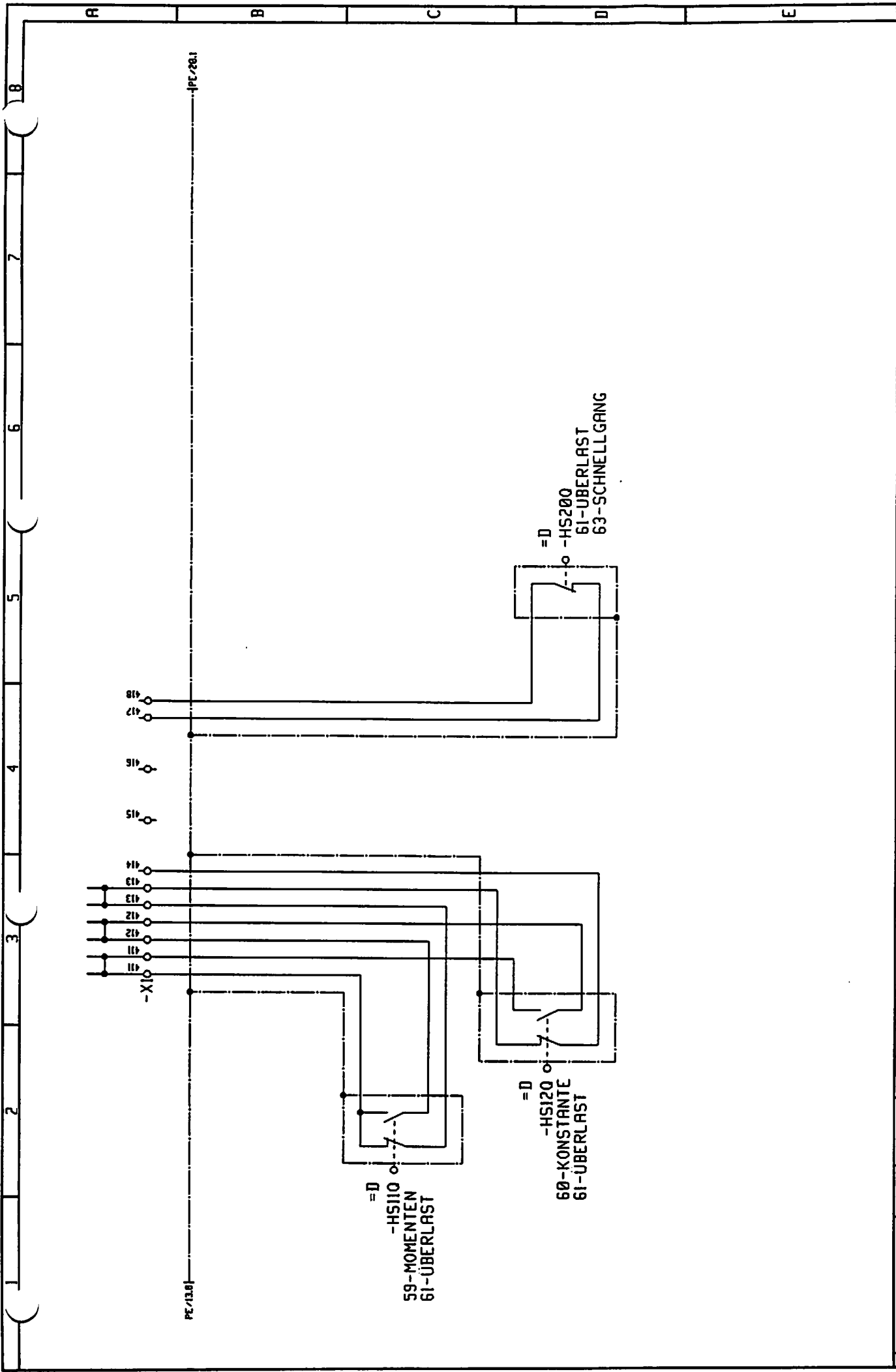

3		Gez.	18.06.90	ELLINGER		LIEBHERR MERK BIBERRACH	61-ÜBERLAST	TYPE EC	SI
2		Bearb.				BIBERRACH		Zeich.-Nr. 40 05 21434	+
1		Datum	Datum	Name					Blatt 17+
		Herausg.	Datum	Name					

Copyright (c)

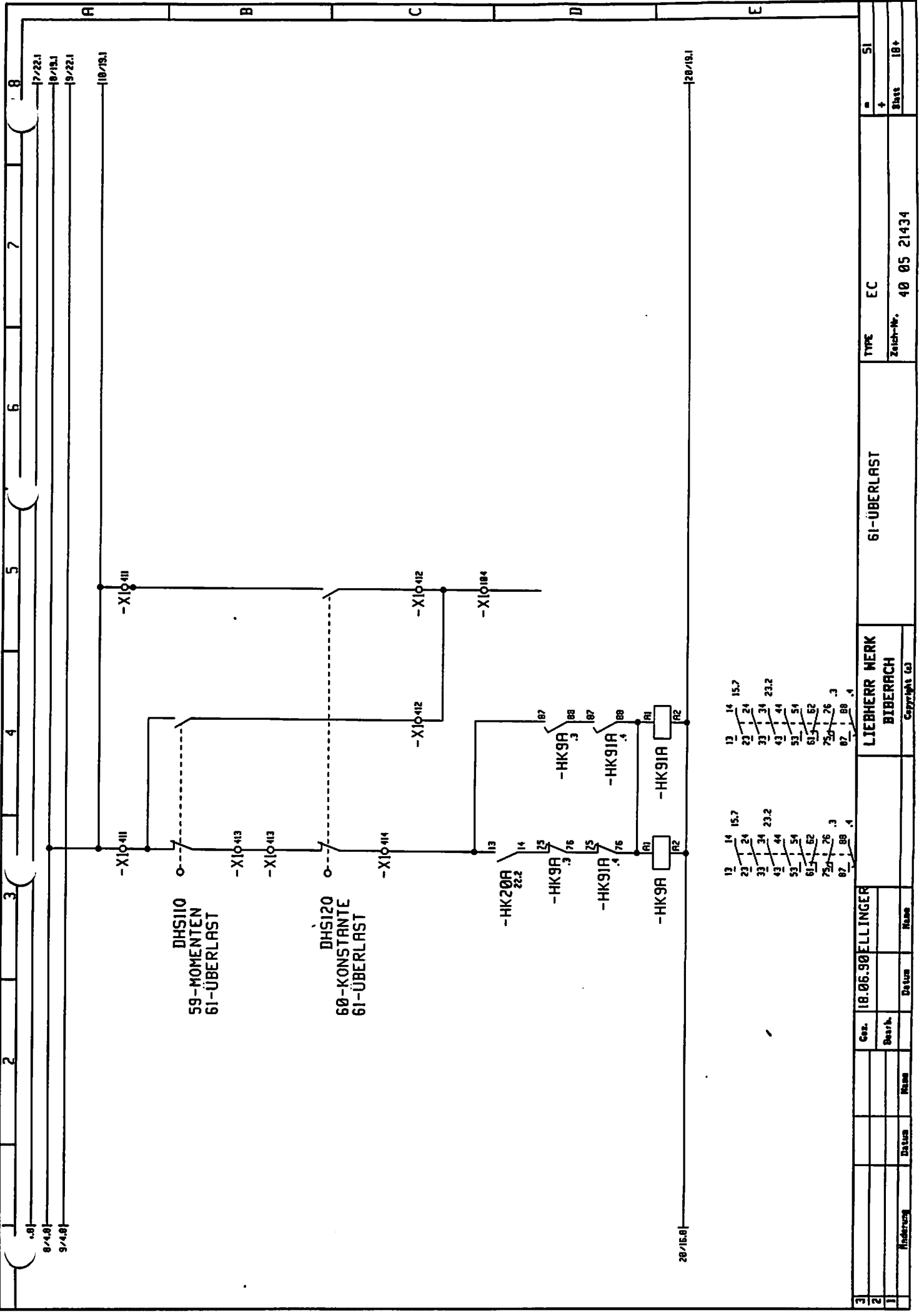

DSI10  
59-MOMENTEN  
61-ÜBERLAST

DSI12  
60-KONSTANTE  
61-ÜBERLAST

3	Ansprechung	Datum	Name	Gez. 18.06.50 ELLINGER	LIEBHERR MERK BIBERACH	61-ÜBERLAST	TYPE EC	SI
2		Datum	Name				Zeich.-Nr. 40 05 21434	=
1		Datum	Name				Blatt 18+	+ Blatt 18+

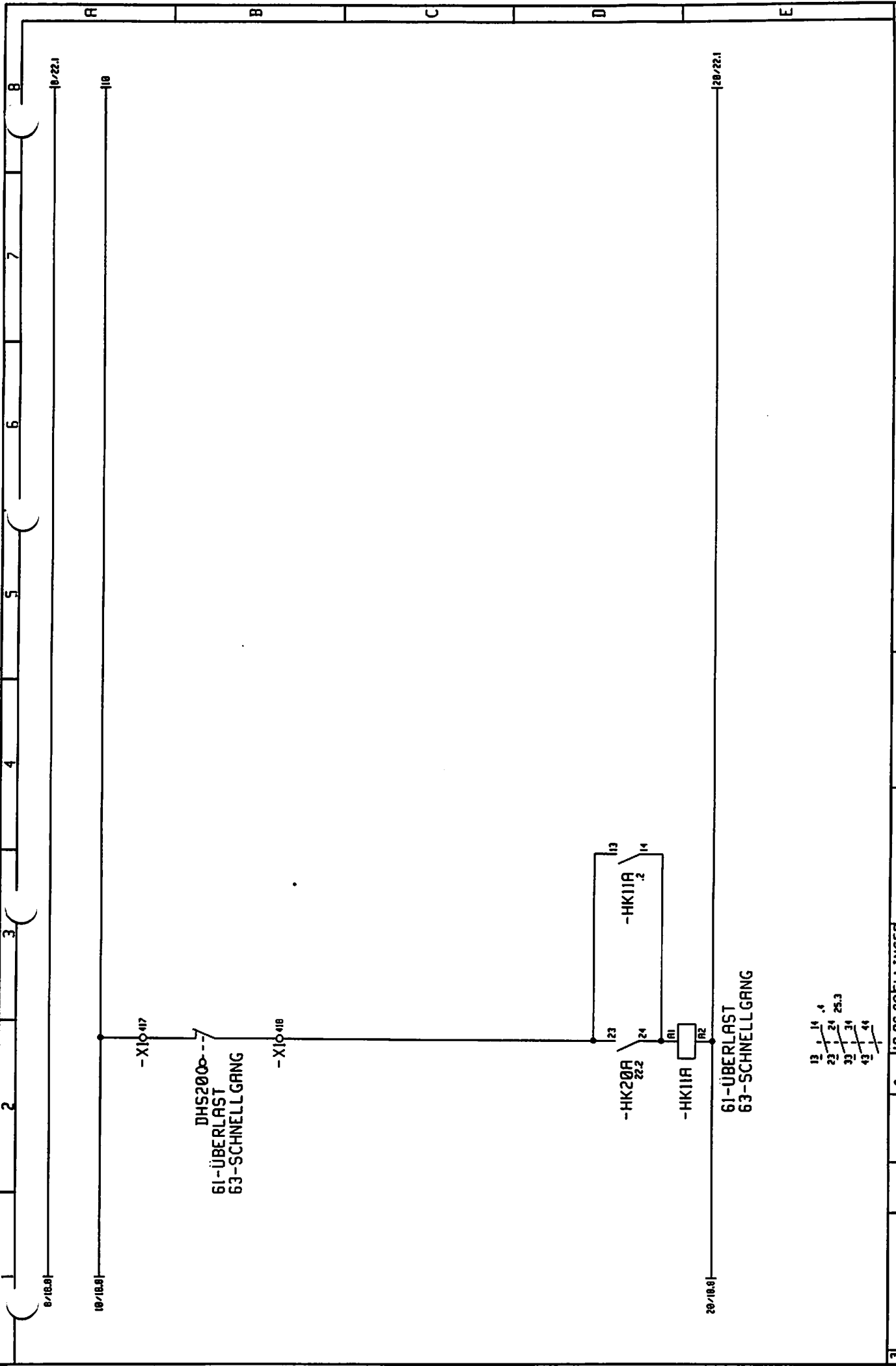

13 1 14 4  
 22 1 24 25.3  
 33 1 34  
 43 1 44

Findierung	Datum	Name	Bearb.	Ges.	18.06.90	ELLINGER	LIEBHERR MERK BIBERACH	61-ÜBERLAST	TYPE	EC	SI
3											
2											19+
1											
							Copyright GJ			Zeich.-Nr.	40 05 21434

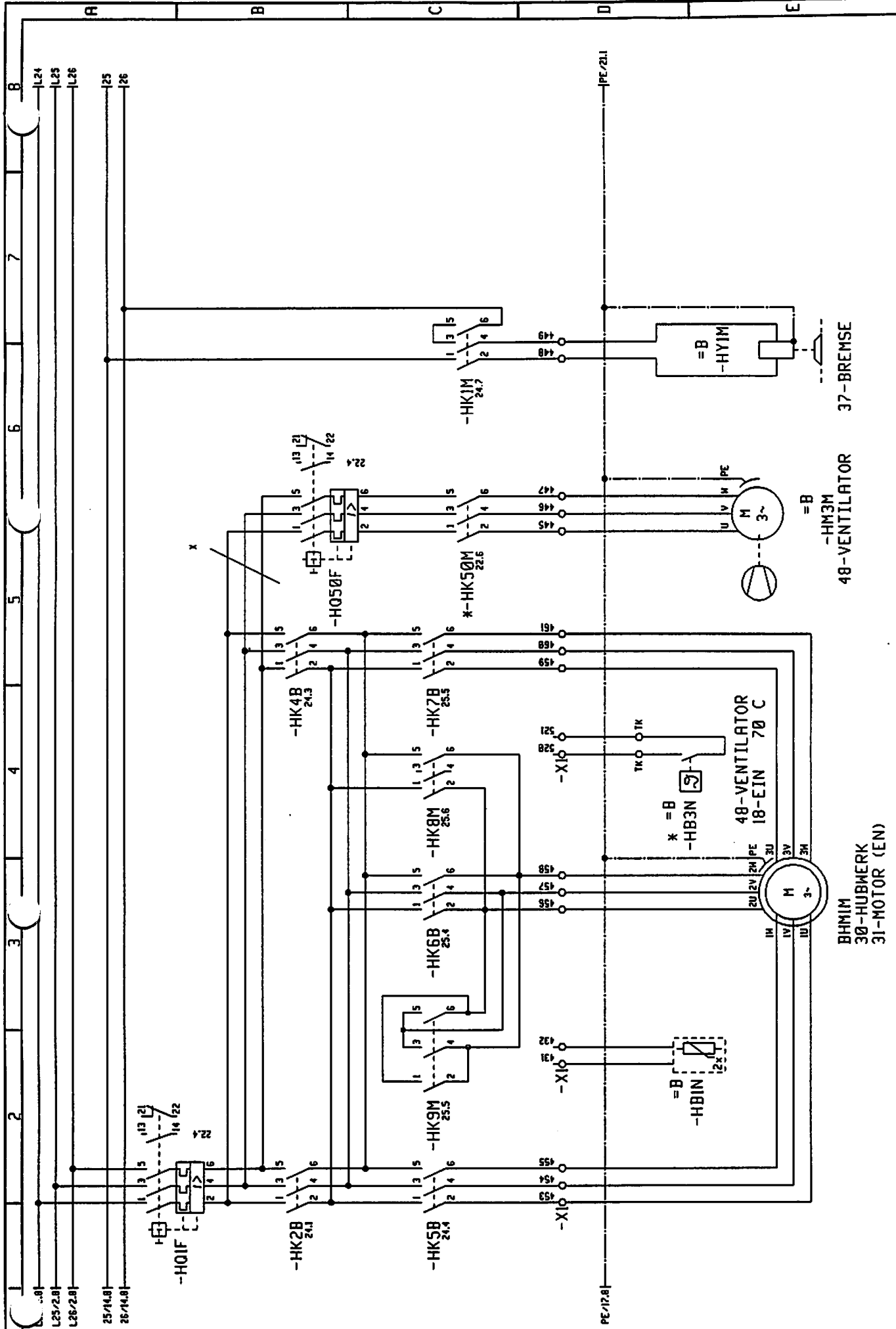

3	Gez.	18.06.90	ELLINGER							TYPE	EC
2	Bauh.									Zeich-Nr.	40 05 21434
1	Name									Blatt	20+
	Datum										
	Name										
	Datum										
	Name										
	Datum										
	Name										
	Datum										
	Name										

30-HUBWERK  
LIEBHERR WERK  
BIBERACH  
Copyright ©

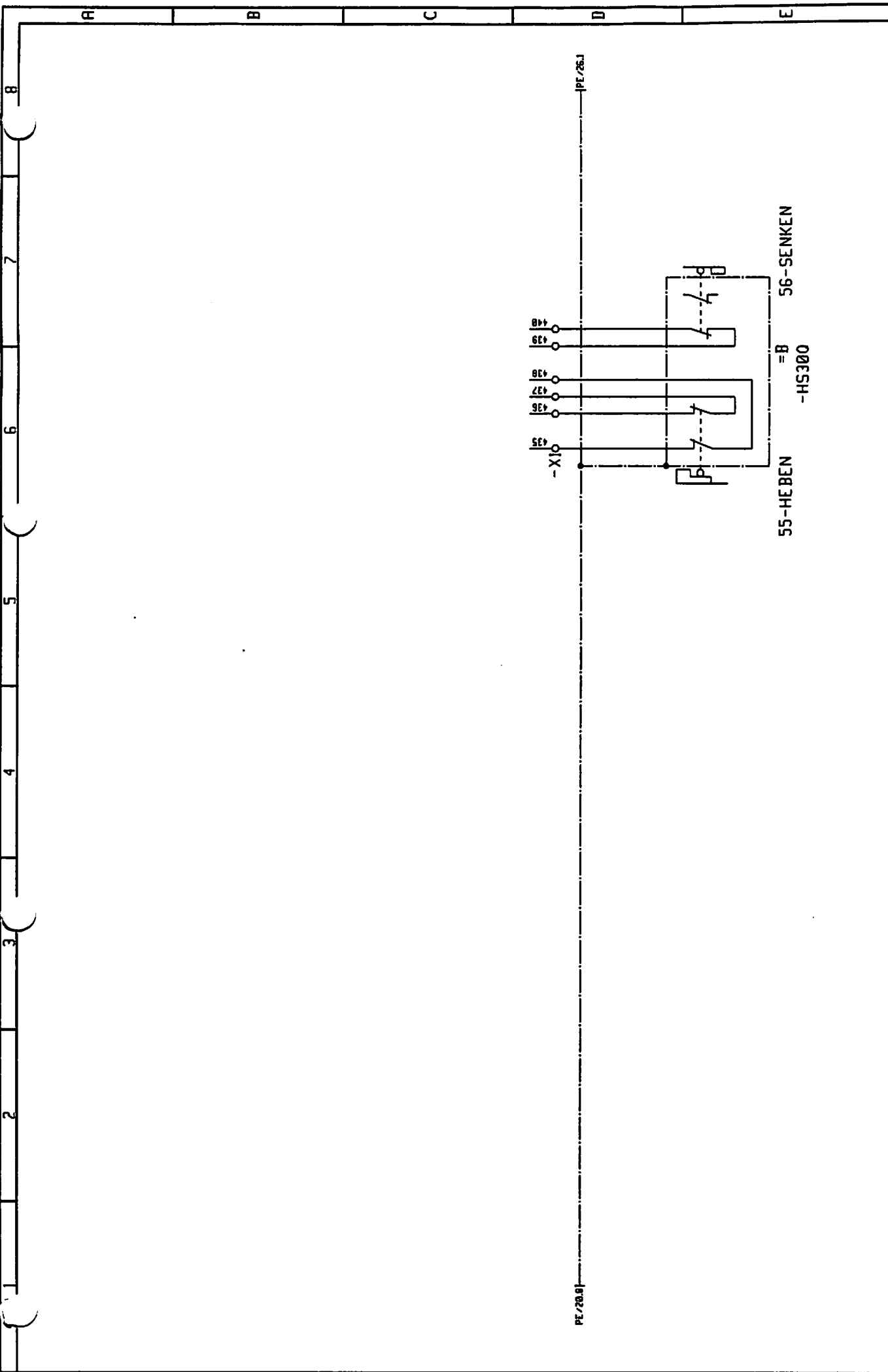

3		Cas.	18.06.90	ELLINGER		LIEBHERR MERK BIBERACH	30-HUBHERK	TYPE	EC	=	SI
2		Bestk.								+	
1		Name		Date	Name						Blatt
											21+
						Copyright (c)					
						Zeich.-Nr.	40 05 21434				

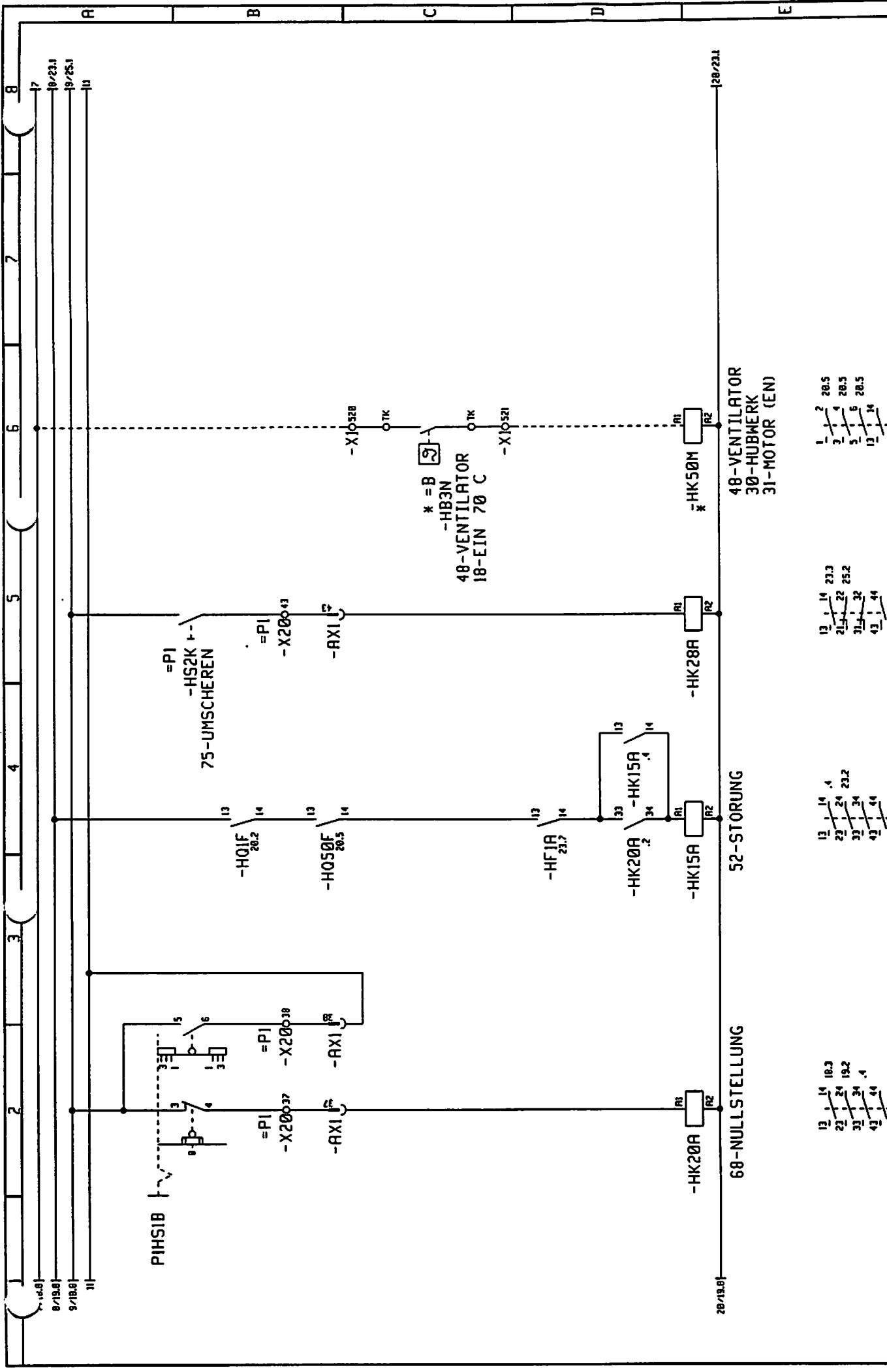

3	Conz.	18.06.90 ELLINGER							LIEBHERR MERK		30-HUBWERK	TYPE	EC		=	51
2	Bearb.								BIBERRACH					Zeich.-Nr.	+	22+
1	Änderung		Datum	Name	Datum	Name		Copyright (c)						Blatt		
														40 05 21434		

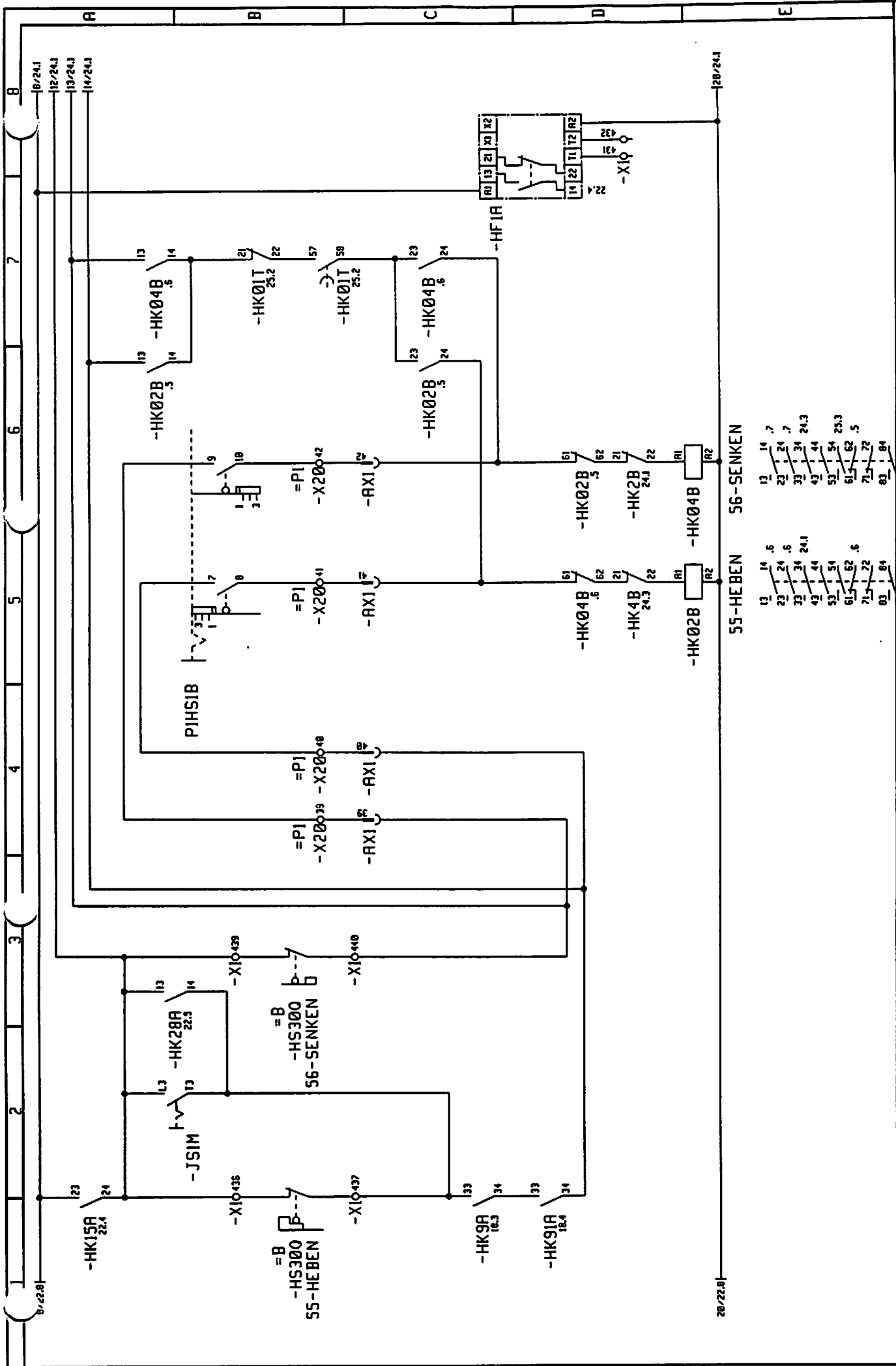

3	Gez.	18.06.90	ELLINGER	LIEBHERR WERK BIBERACH Copyright (c)	30-HUBBERK	TYPE EC Zeich.-Nr. 40 05 21434	+ Blatt 23+	SI
2	Gez.							
1	Gez.							

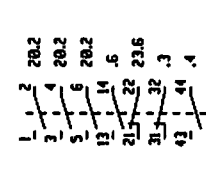
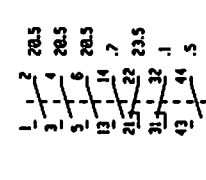
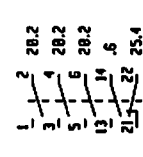
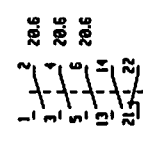
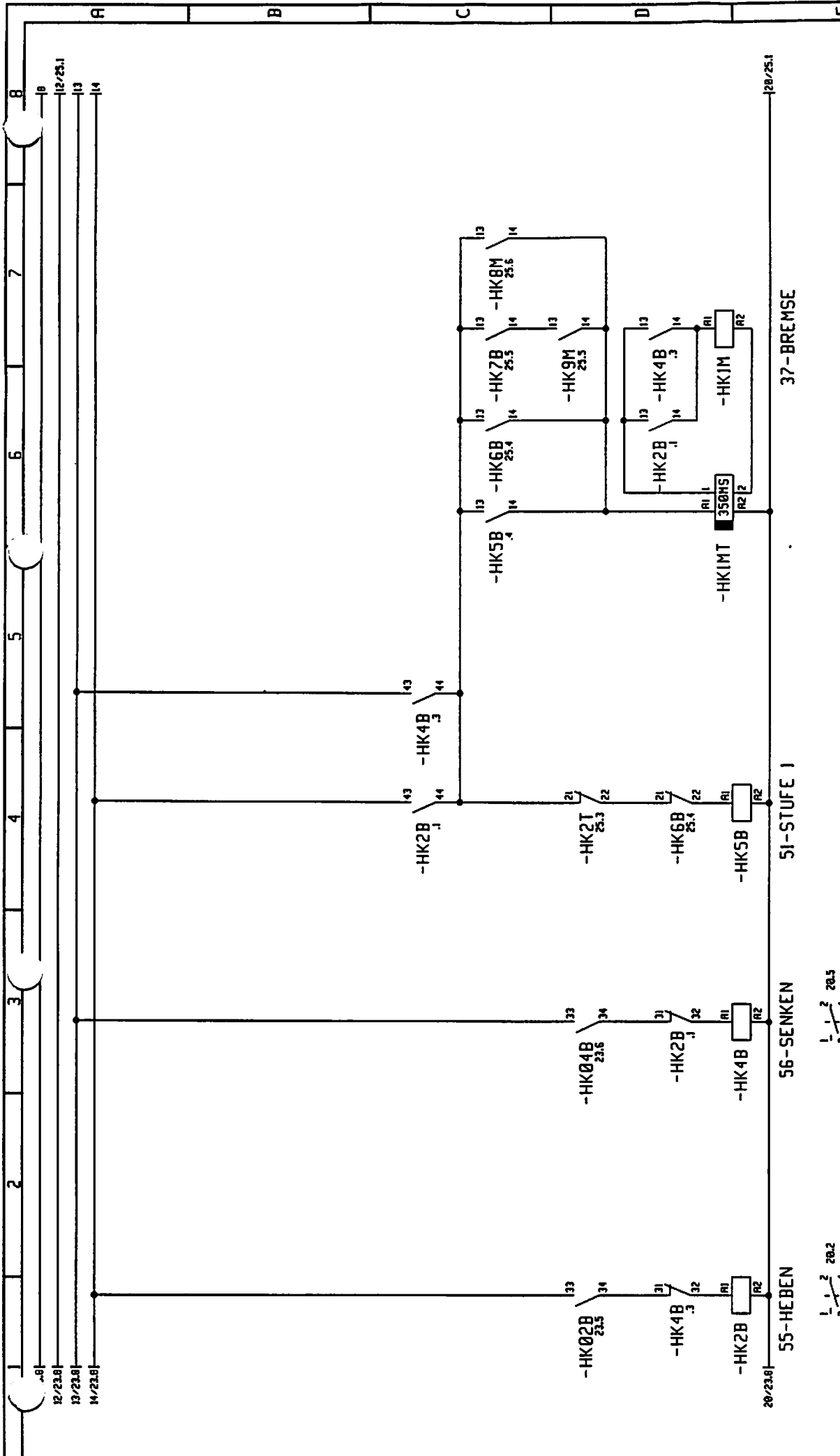

37-BREMSE

51-STUFE 1

56-SENKEN

55-HEBEN

30-HUBMERK		TYPE EC	#	SI
		Zeich-Nr. 40 05 21434	+	Blatt 24+
LIEBHERR MERK BIBERACH <small>Copyright (c)</small>				
18.06.90 ELLINGER		Gez.		
		Best./b.		
		Name		
		Datum		
		Name		
		Datum		
		Name		
		Datum		
		Name		
		Datum		





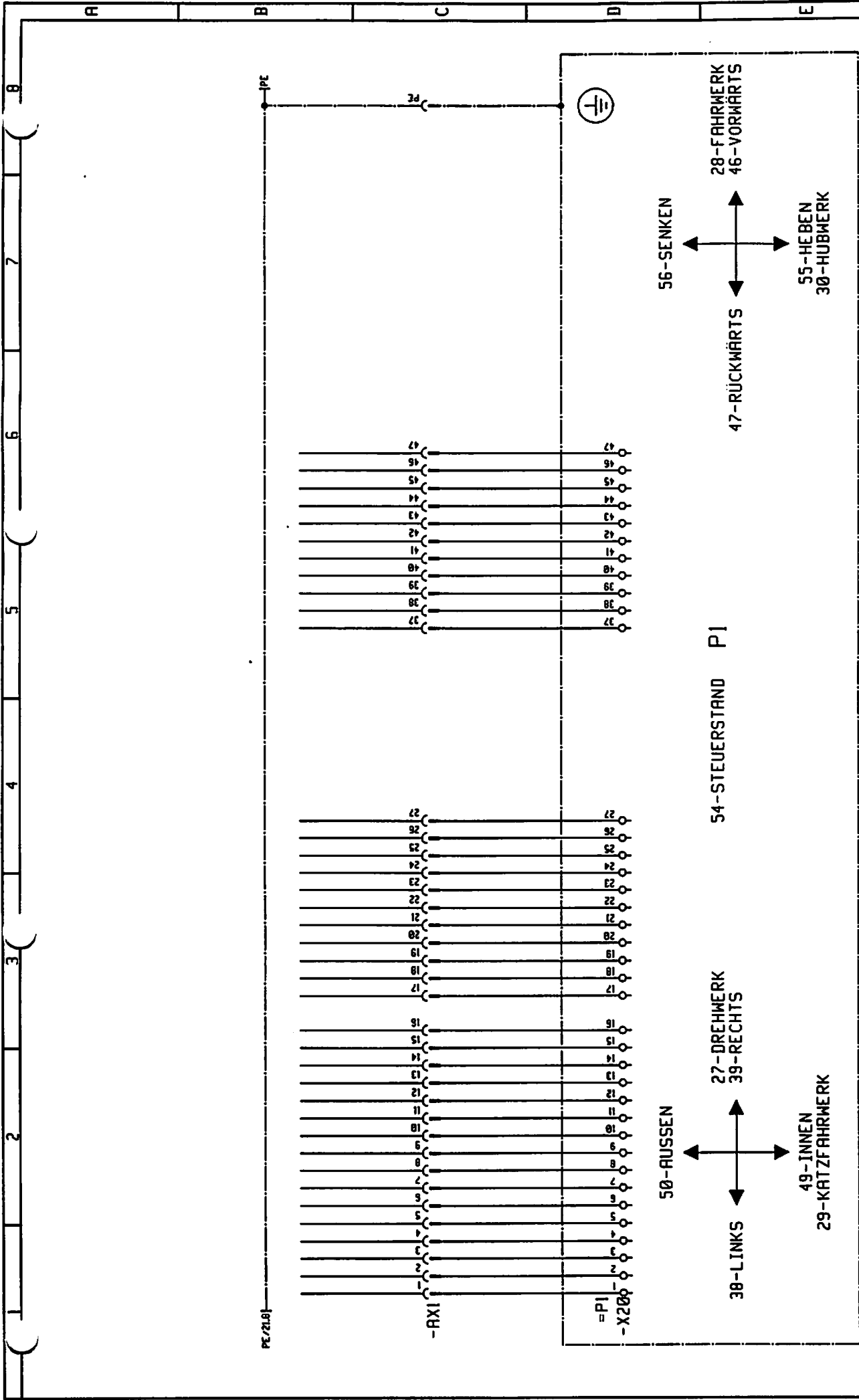

3	Genz.	18.06.90	ELLINGER	LIEBHERR MERK DIBERACH Copyright (c)	54-STEUERSTAND	TYPE EC	=	SI
2	Bearb.							
1	Änderung	Datum	Name	Datum	Name			

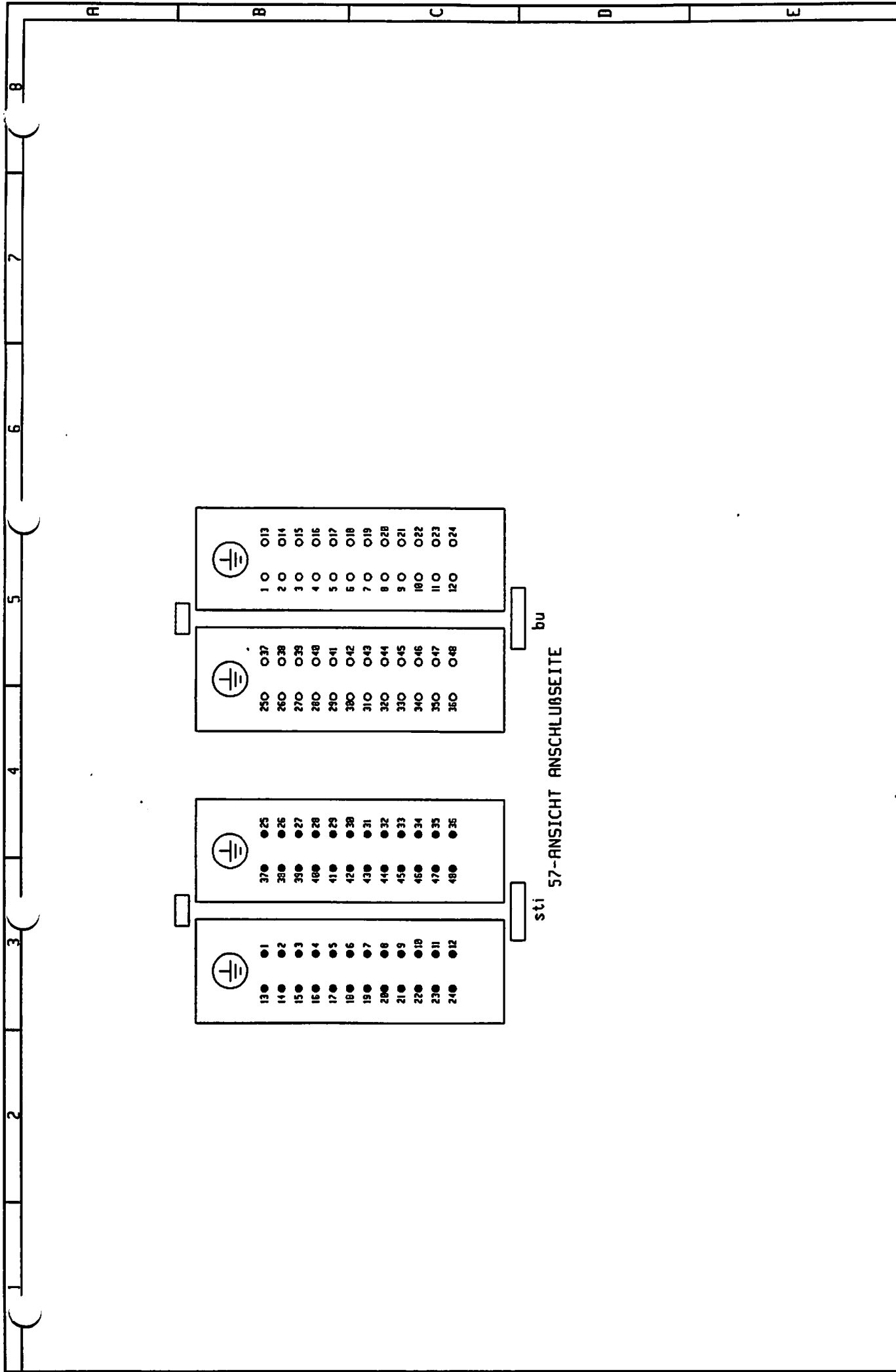

3	Gez.	18.05.90 ELLINGER		TYPE	EC	SI
	Bezeichnung	Name	Datum		Zeich.-Nr.	
2	Gez.			54-STECKERBINDER	Blatt	27+
1	Bezeichnung	Name	Datum			
				LIEBHERR MERK BIBERACH		
				Copyright (c)		