

57-ANSICHT  
ANSCHLUßSEITE

Sfi

bu

—RS510  
20-TÜRENDSCHALTER

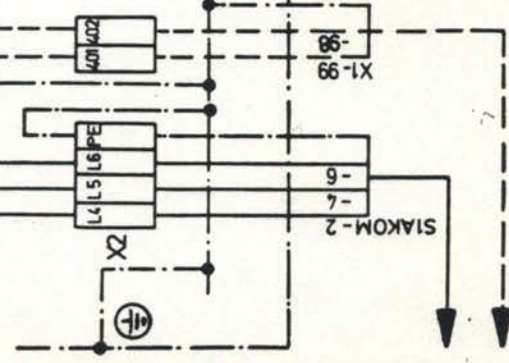

\* = 10 - NICHT SERIENMÄSSIG

S2

1 2 3 4 5 6 7 8

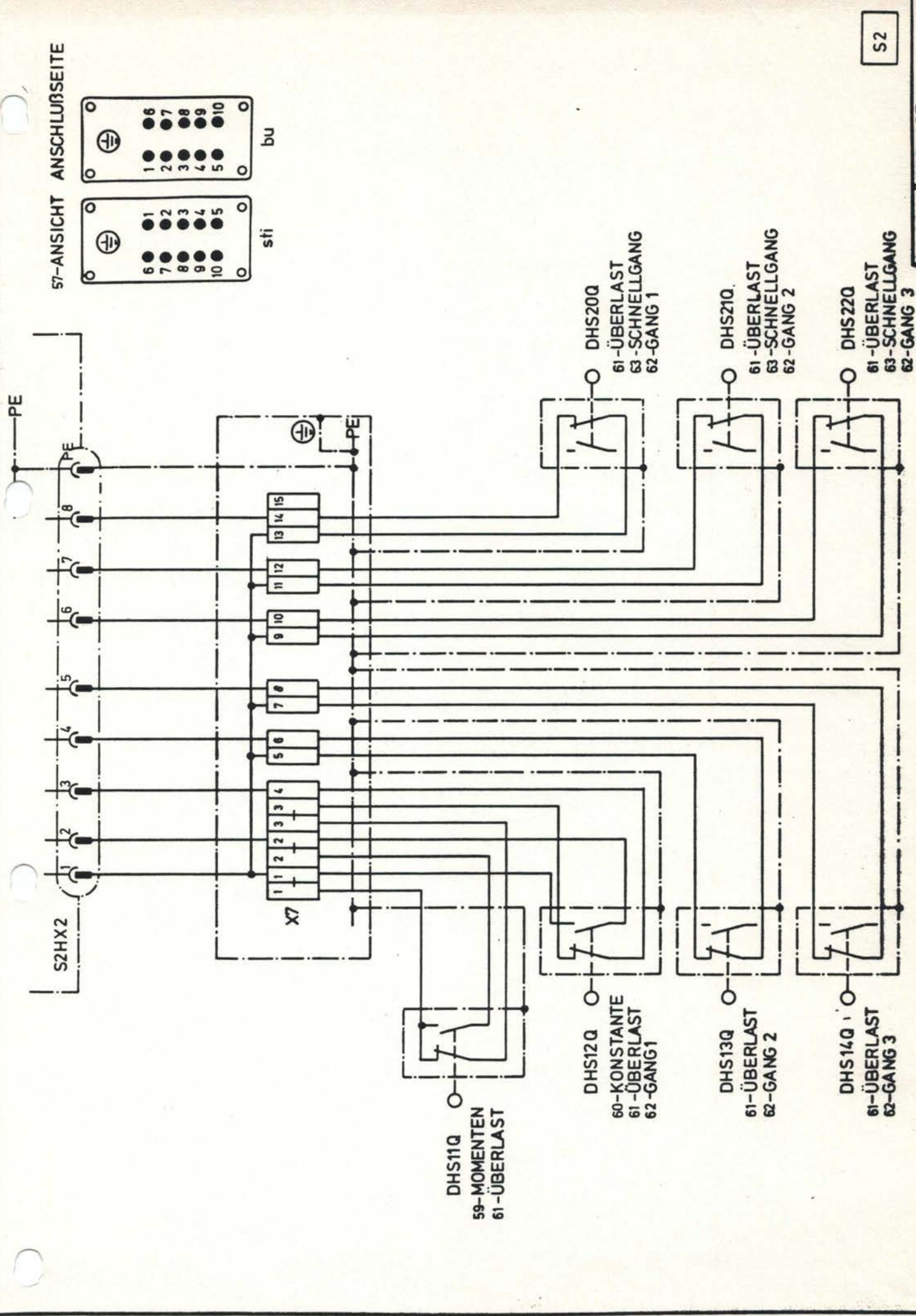

57-ANSICHT ANSCHLUßSEITE

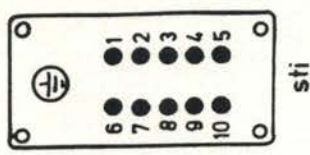



1 2 3 4 5 6 7 8

S2

Gruppe 36 - RESERVE  
Zeich Nr 4005 21417 Blatt 3 von 15

LEBENS-VERSICHERUNG  
VERSICHERUNG

Die Versicherung wird durch die Lebensversicherungsgesellschaft  
AG in Berlin am 1. April 1905 abgeschlossen.  
Die Versicherung wird durch die Lebensversicherungsgesellschaft  
AG in Berlin am 1. April 1905 abgeschlossen.



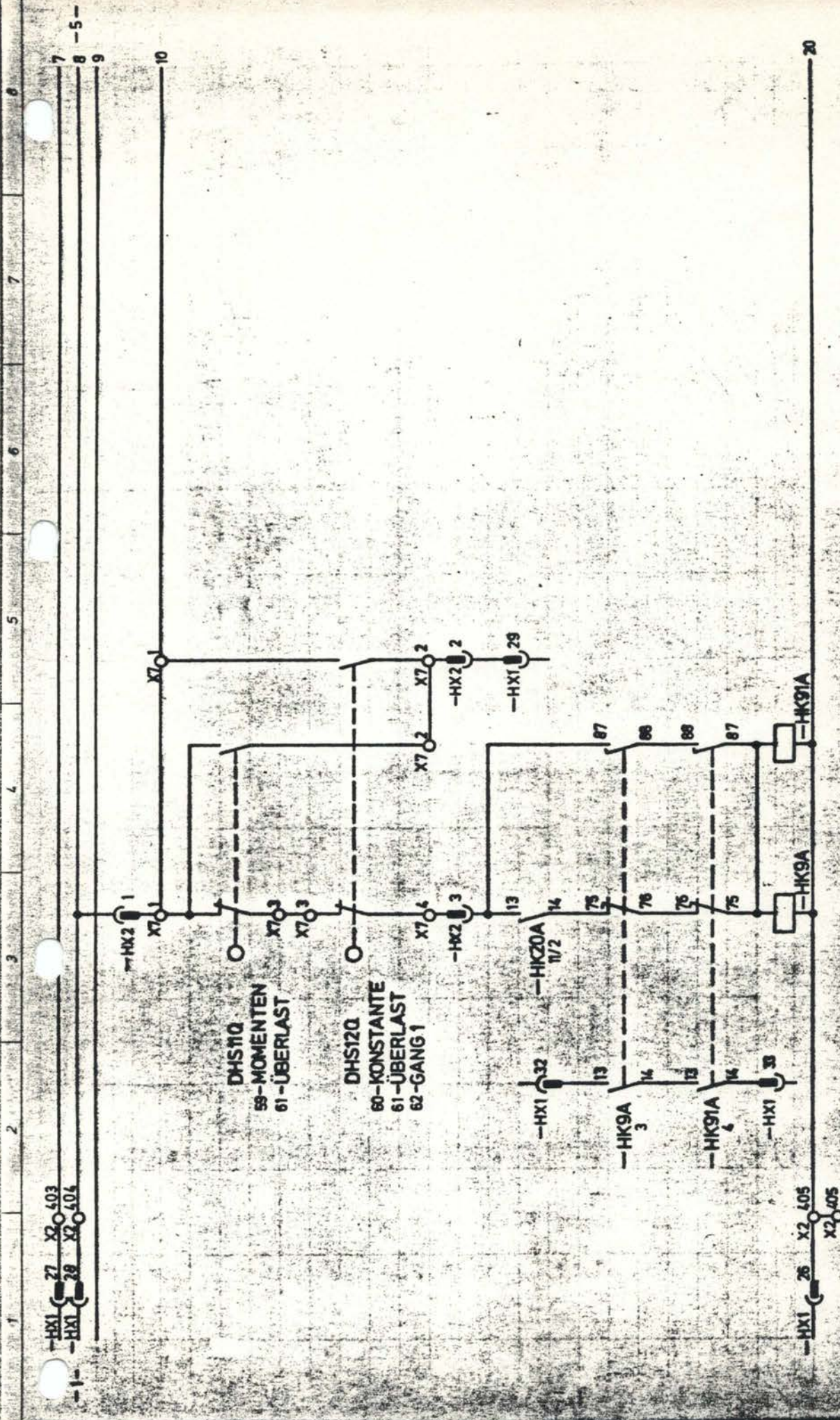

1 2 3 4 5 6 7 8 9 10  
 -1-  
 -HX1 27 X2 403  
 -HX1 28 X2 404  
 -HX2 1  
 X7 1  
 DHS110  
 59-MOMENTEN  
 61-ÜBERLAST  
 X7 3  
 X7 3  
 DHS120  
 60-KONSTANTE  
 61-ÜBERLAST  
 62-GANG 1  
 X7 4  
 X7 2  
 X7 2  
 -HX2 2  
 -HX1 29  
 -HX2 3  
 -HX1 32  
 -HK20A 11/2  
 13 14 75 76 87 88 89  
 -HK9A 3  
 -HK91A 4  
 -HX1 33  
 -HX1 26 X2 405  
 X2 405  
 -HK9A  
 -HK91A

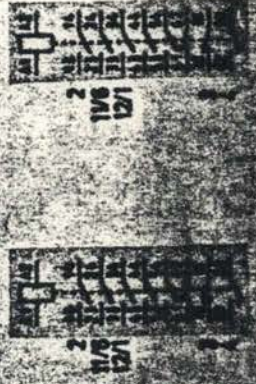



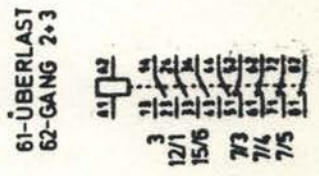
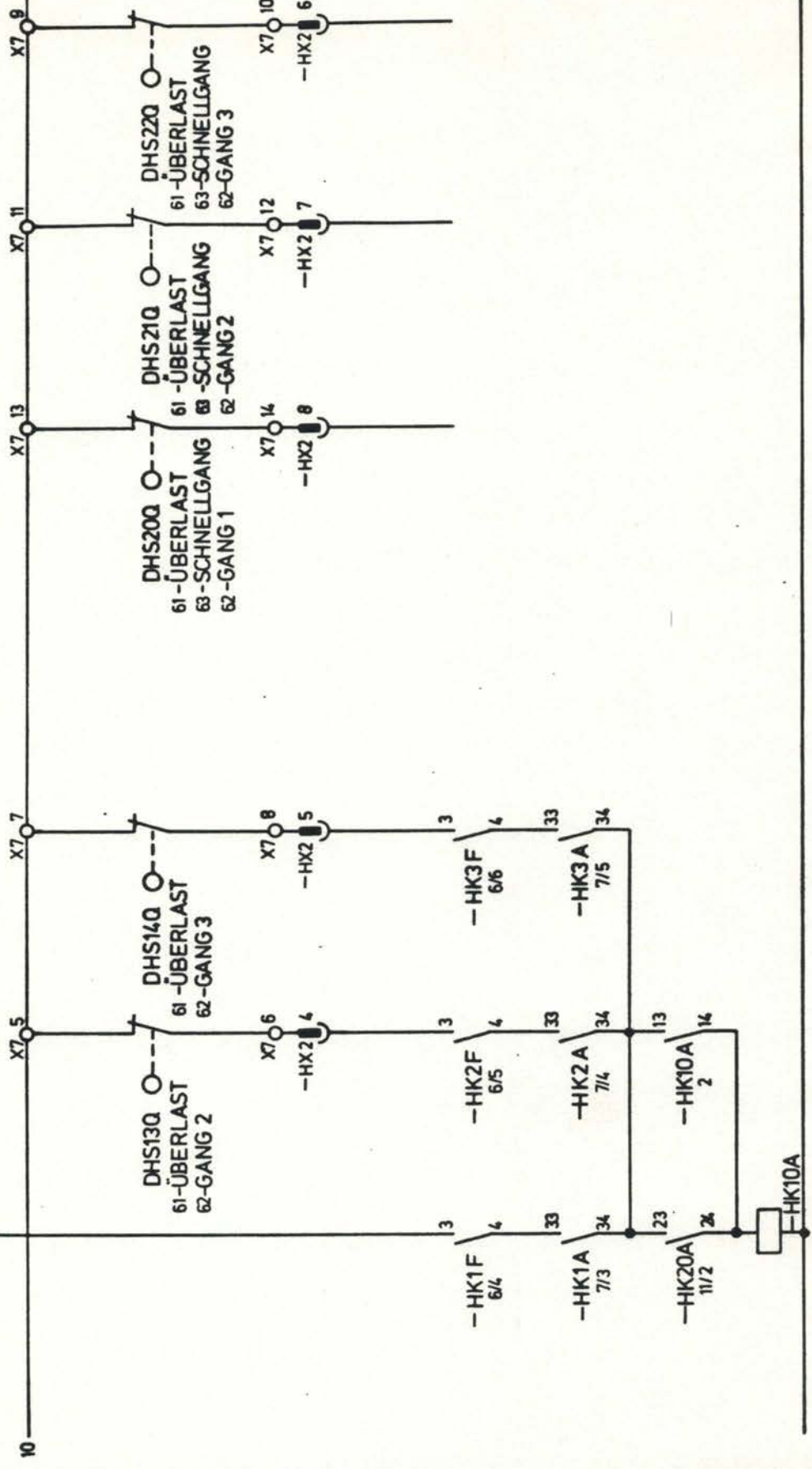
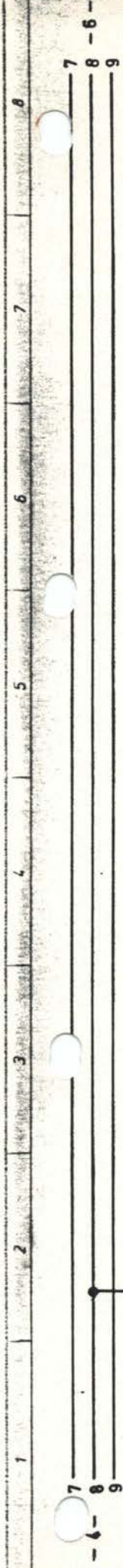

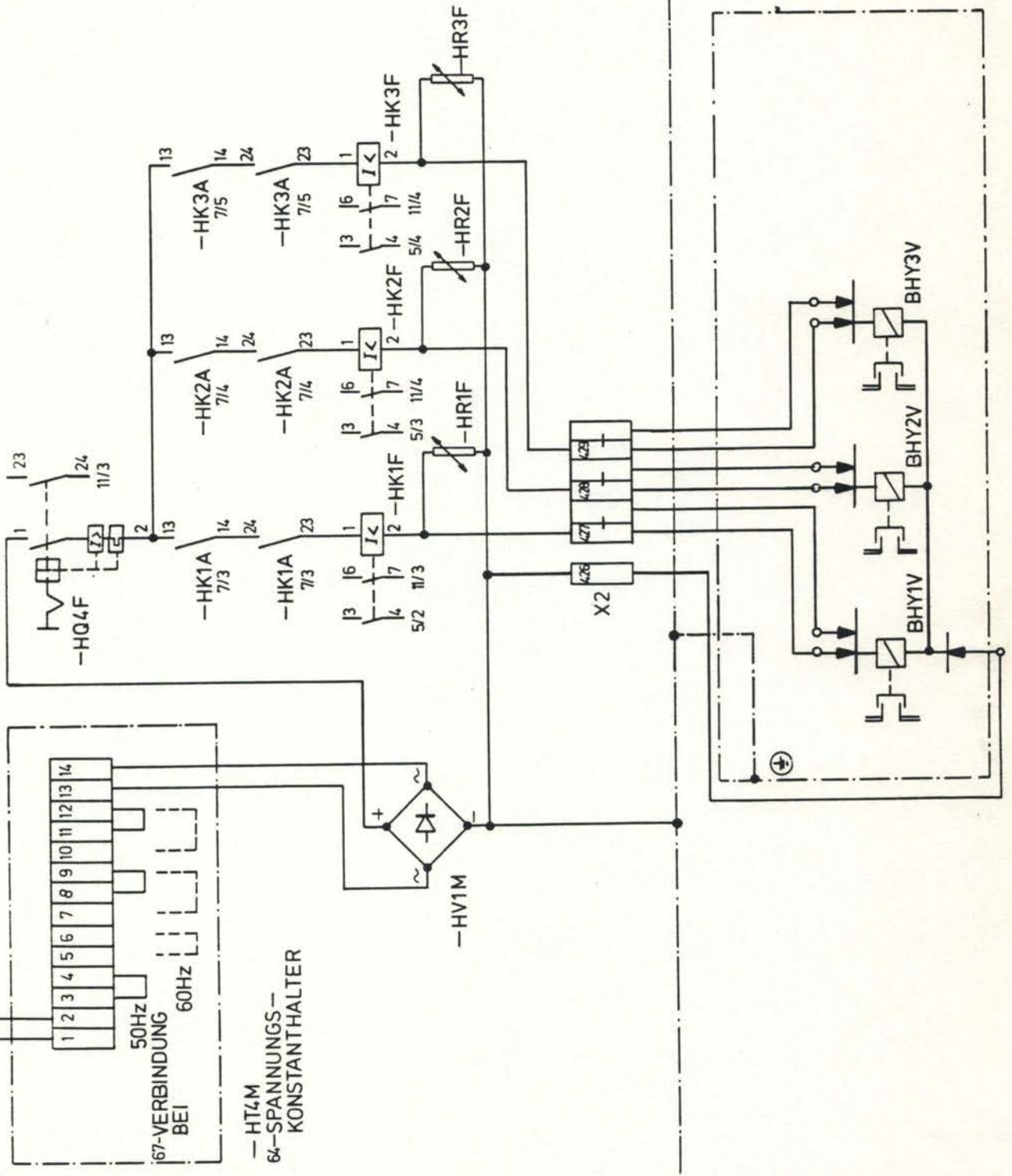

S2



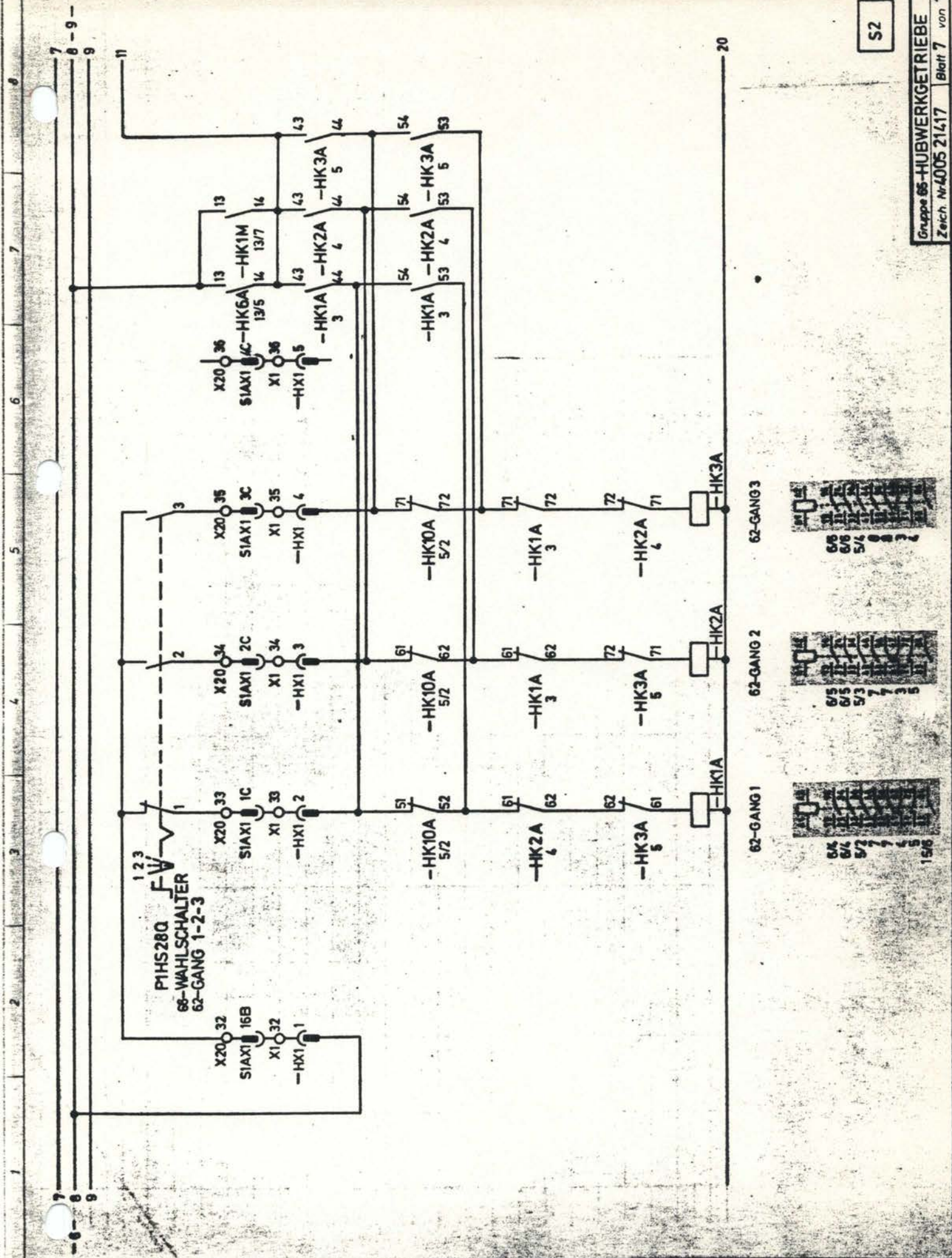



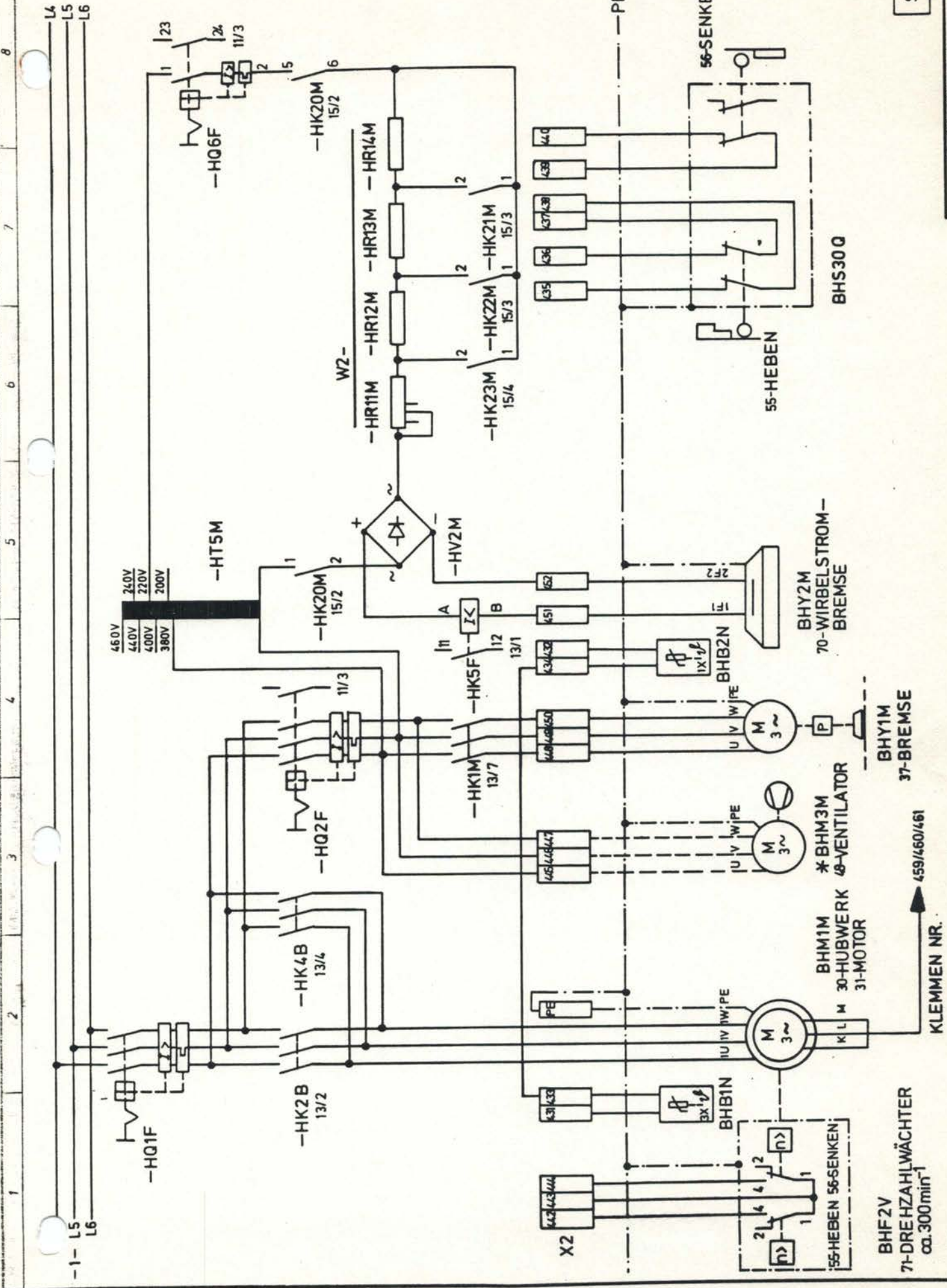

S2

1 2 3 4 5 6 7 8

-1- L5  
L6

460V  
440V  
400V  
380V

240V  
220V  
200V

15/2  
15/3  
15/4

13/4  
13/7  
13/1  
13/2

11/3  
11/3  
11/3

15/2  
15/3  
15/3  
15/3

431KE  
436  
437/438  
440

435  
436  
437/438  
440

431KE  
436  
437/438  
440

435  
436  
437/438  
440

435  
436  
437/438  
440

435  
436  
437/438  
440

435  
436  
437/438  
440

435  
436  
437/438  
440



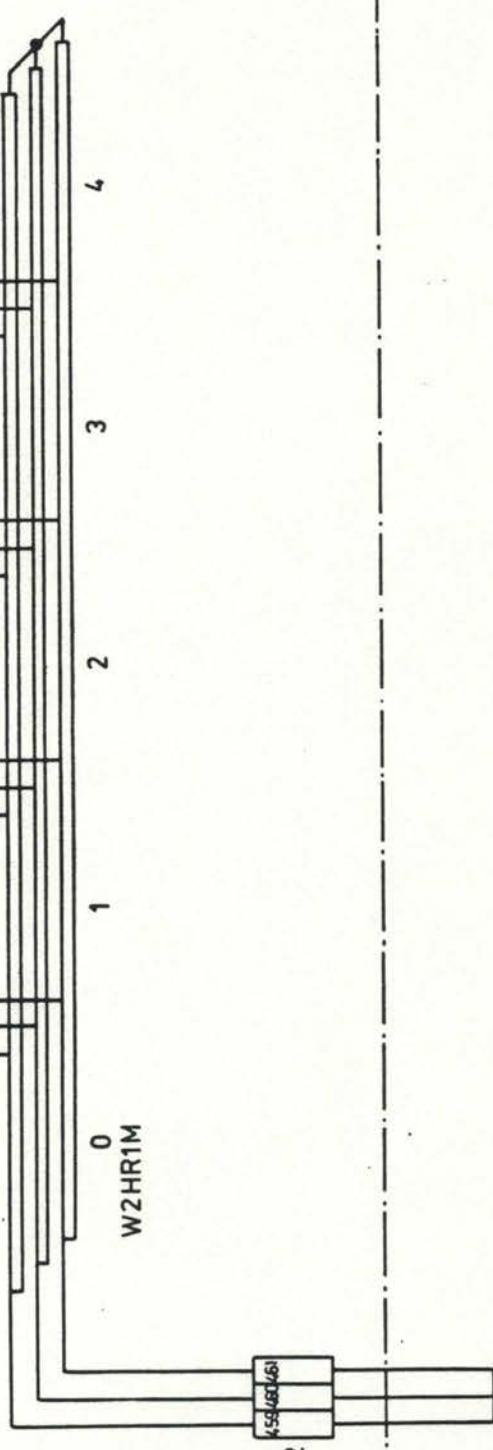
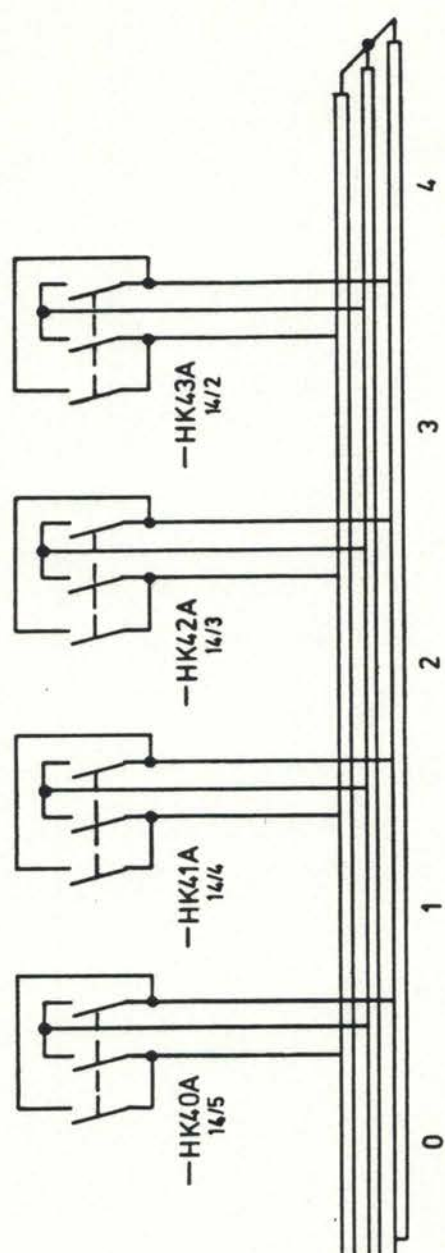
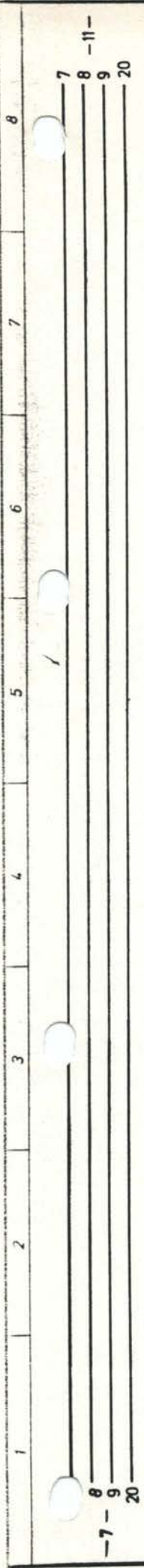

30 - HUBWERK  
31 - MOTOR  
BHM1M



1 2 3 4 5 6 7 8

S2











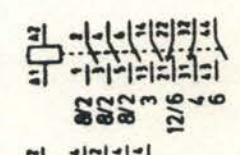
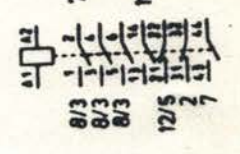
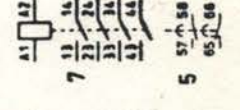
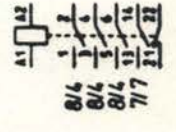
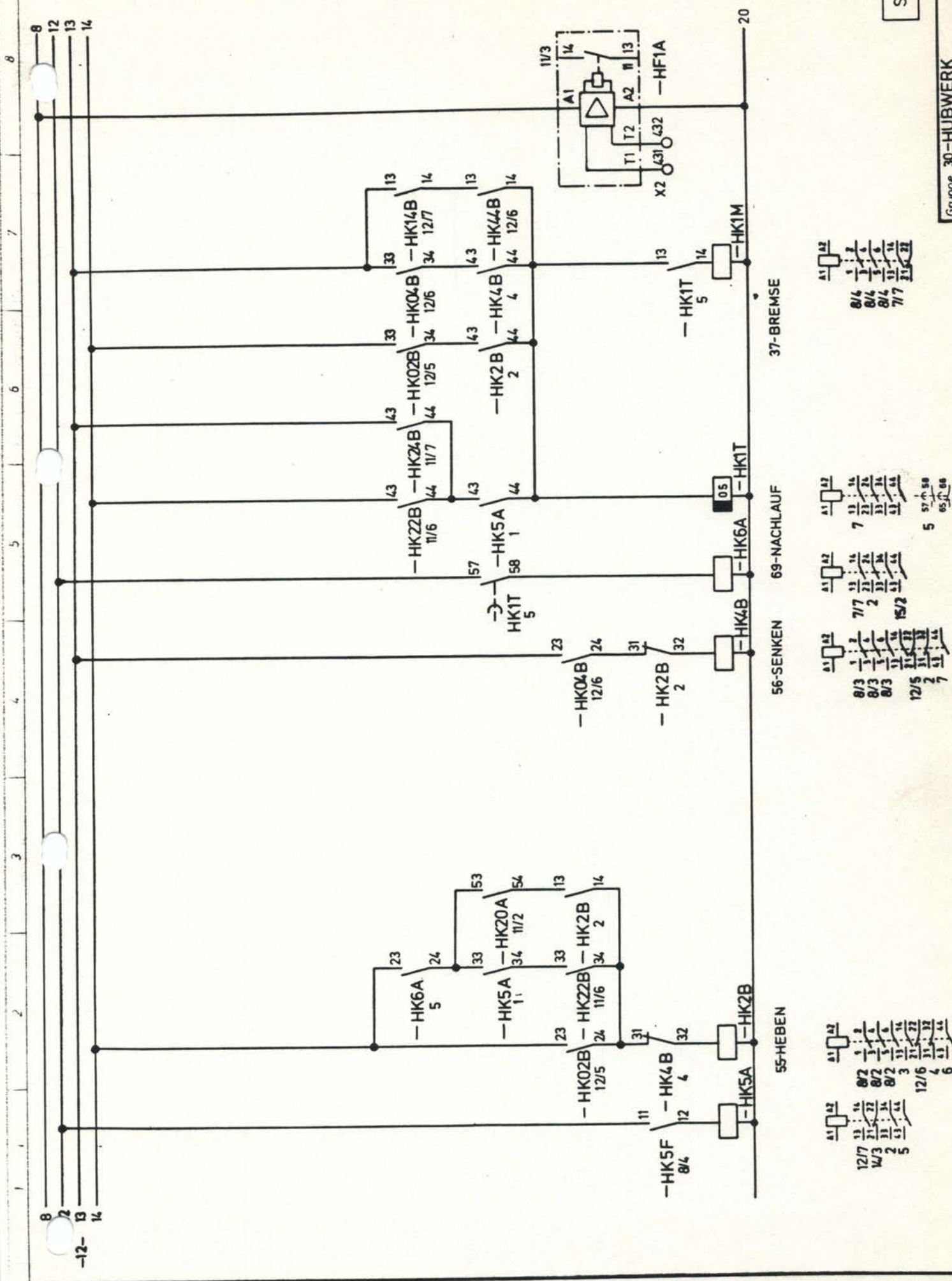



Die Zeichnung ist eine reine Darstellung und hat  
keine Verantwortung nach diesen Angaben gemacht werden  
und Änderungen vorzuziehen zu Schaden gemacht werden  
und bei Verlust wieder Anfertigung mit 9 1952

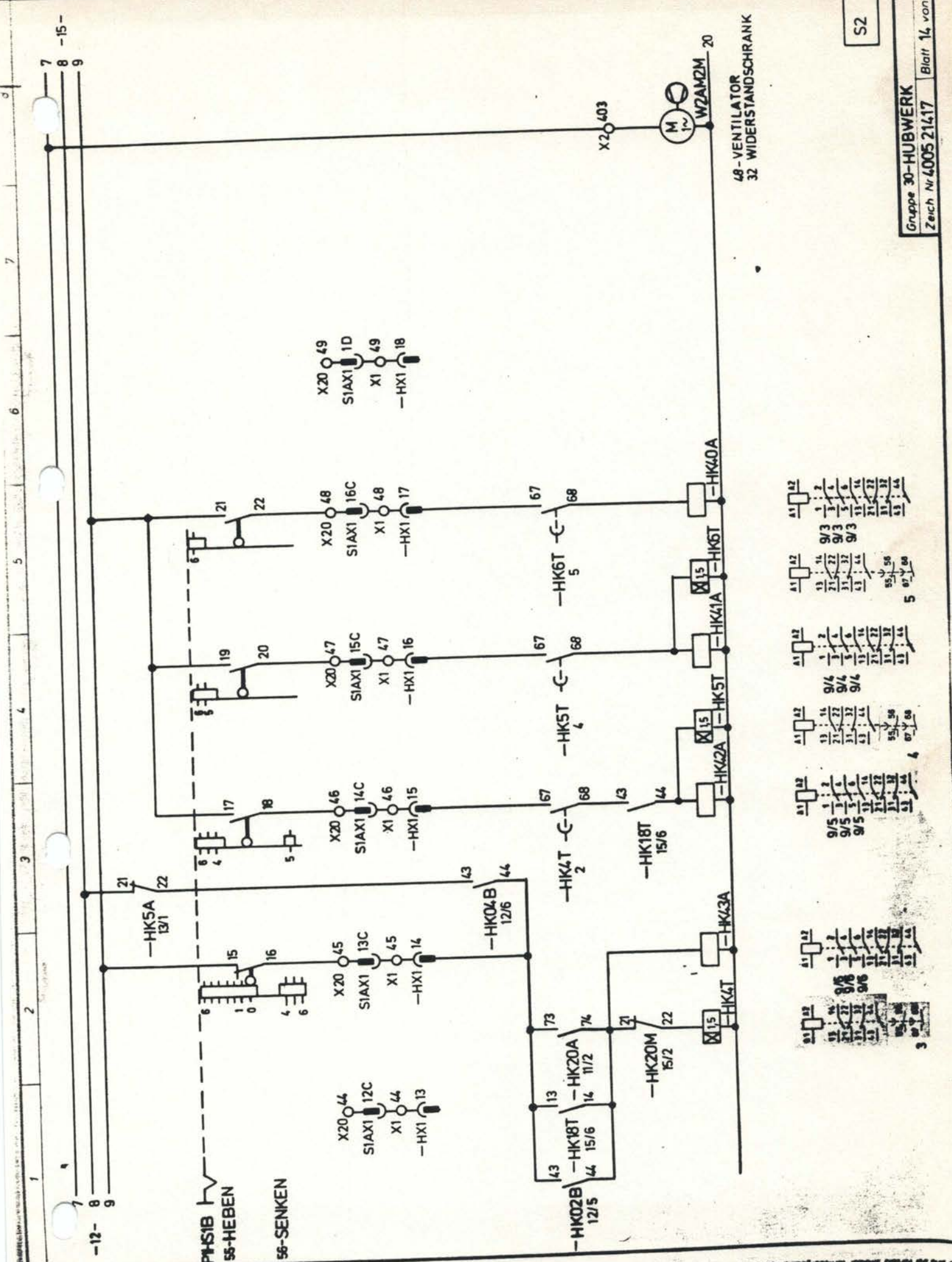

48-VENTILATOR  
32 WIDERSTANDSCHRANK

S2



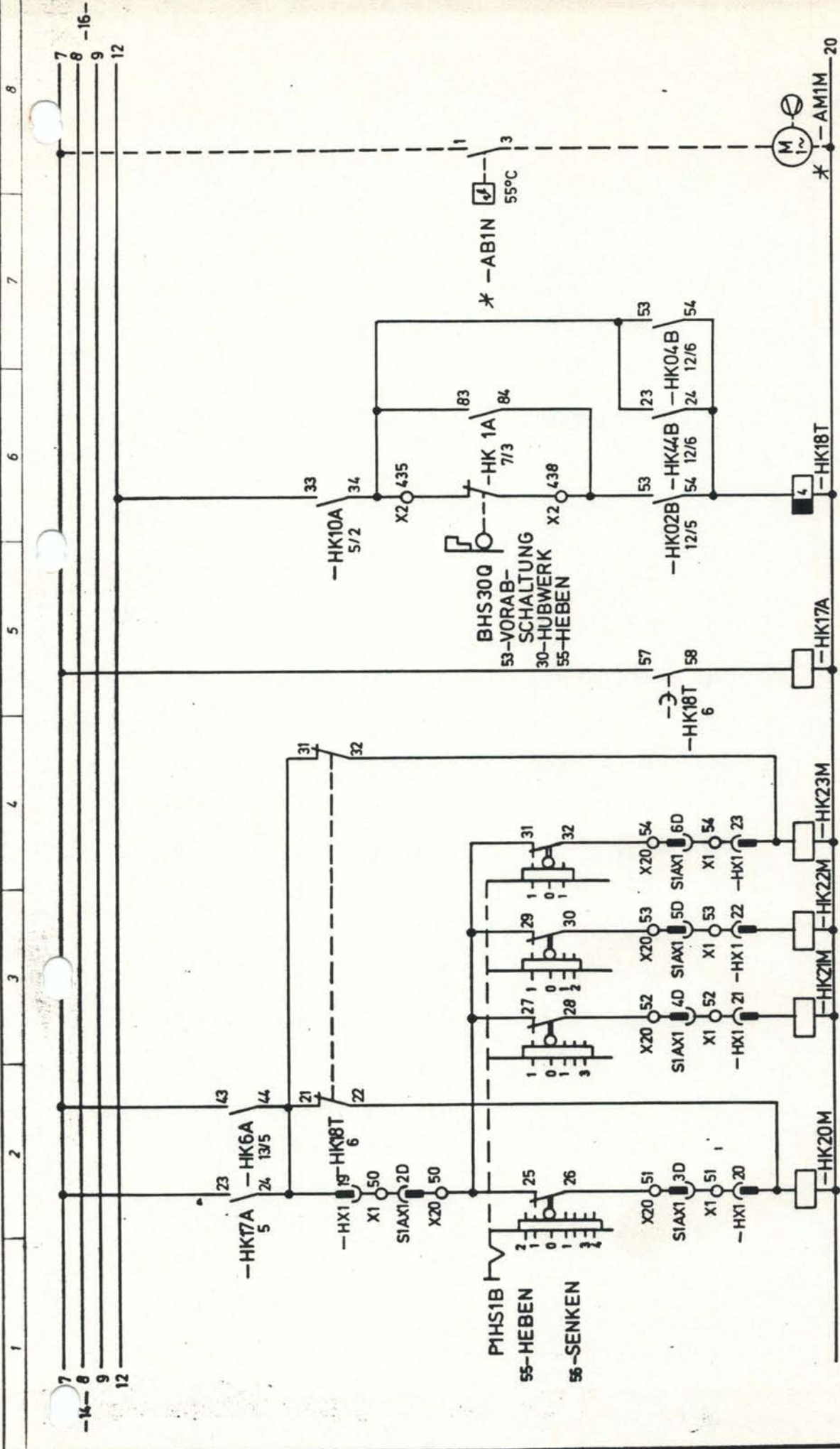

48-VENTILATOR  
14-SCHALTSCHRANK S2

