

3			Gez.	31.08.09	ELLINGER	Maßstab	LIEBHERR-WERK	61-ÜBERLAST	TYPE	HC+EC-H GB-AUSFÜHRUNG	=	S2	
2			Bearb.			:	BIBERACH GmbH		Zeich-Nr.	4005-21369	+	Blatt	2+
1	Änderung	Datum	Name	Datum	Name		Copyright (c)					Ident Nr.	

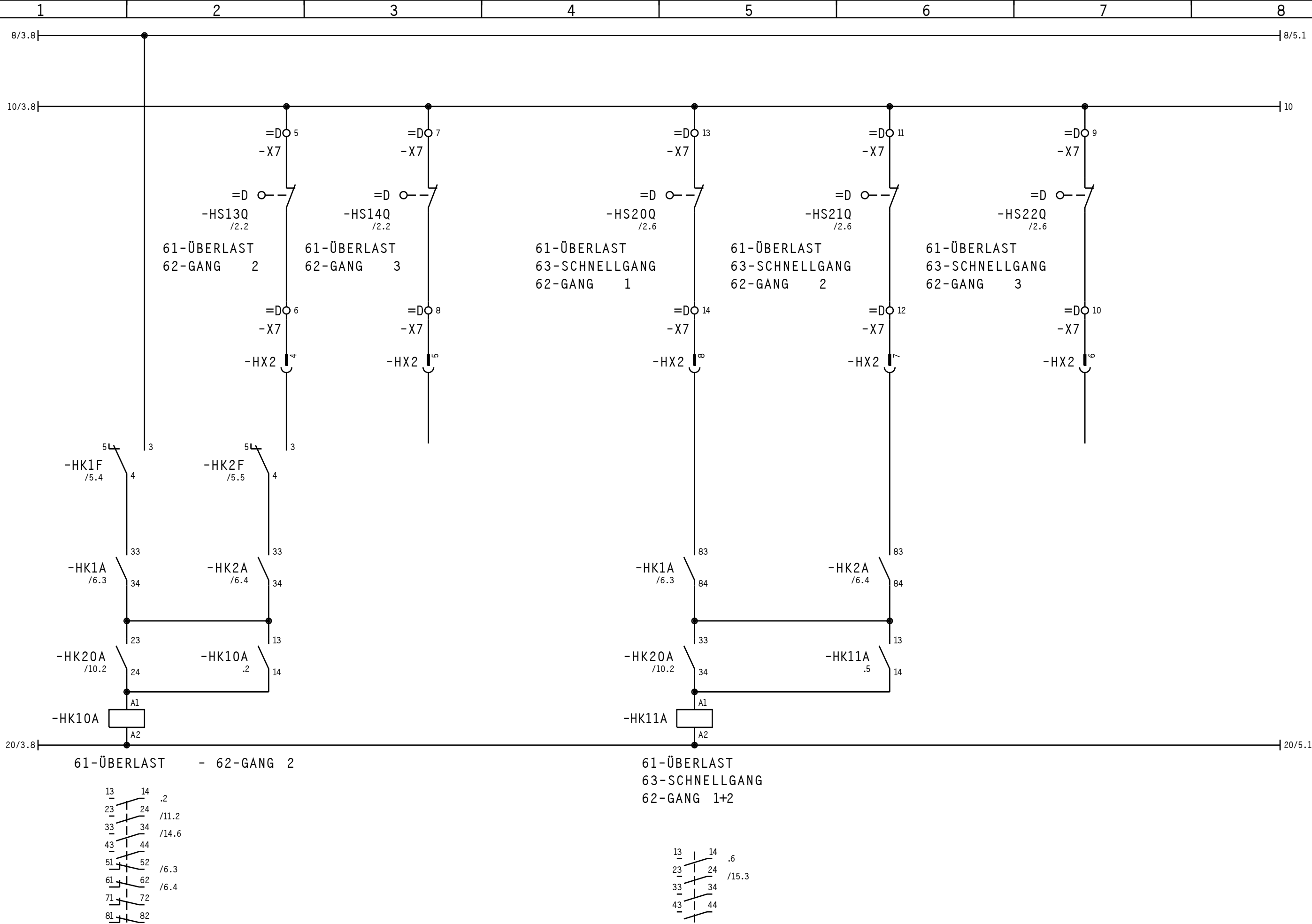

3			Gez.	31.08.09	ELLINGER		Maßstab	LIEBHERR-WERK	61-ÜBERLAST	TYPE	HC+EC-H GB-AUSFÜHRUNG	=	S2
2			Bearb.			:	BIBERACH GmbH	Zeich-Nr.		4005-21369	+	Blatt	4+
1	Änderung	Datum	Name	Datum	Name		Copyright (c)					Ident Nr.	

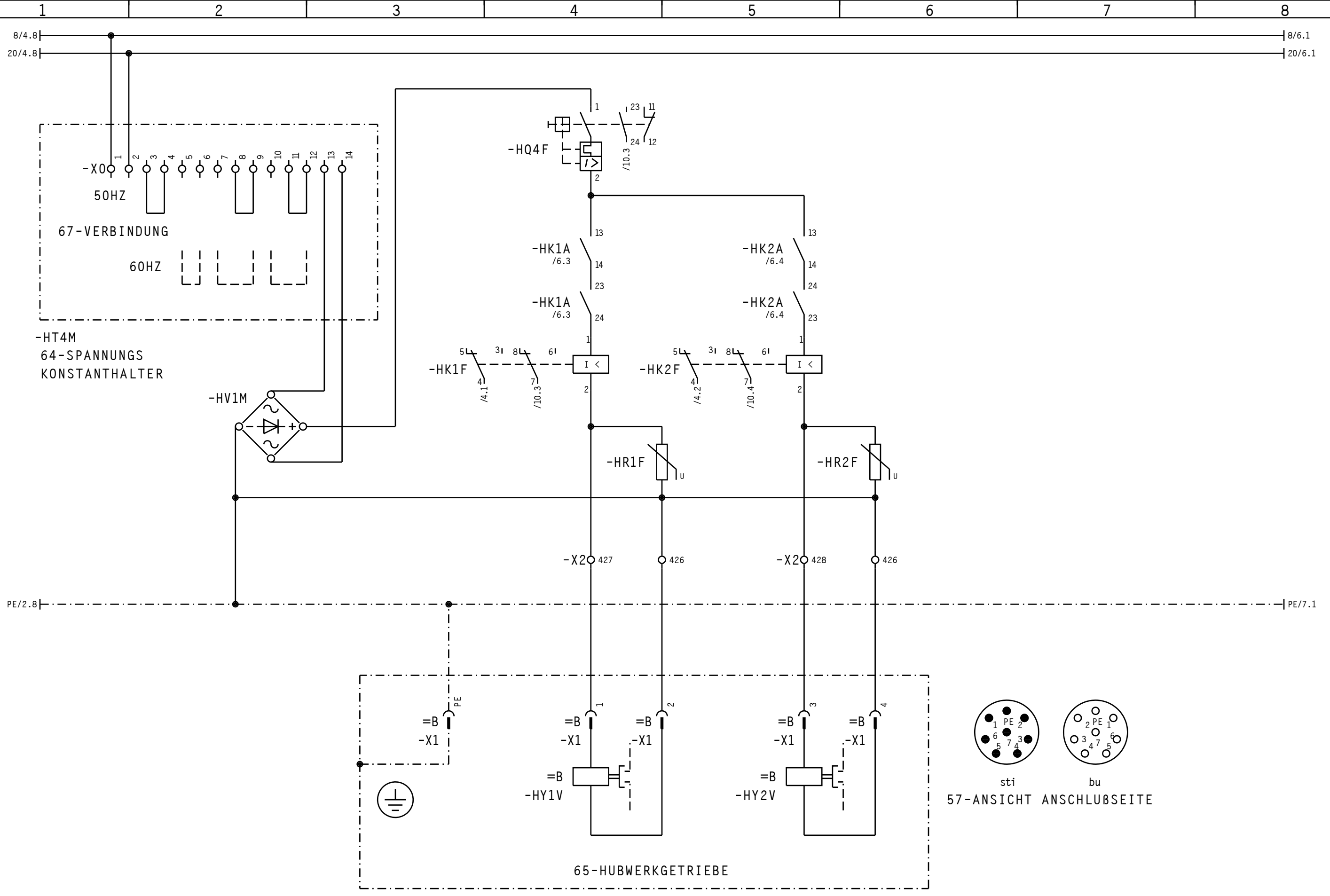

3			Gez.	31.08.09	ELLINGER		Maßstab	LIEBHERR-WERK	65-HUBWERKGETRIEBE	TYPE	HC+EC-H GB-AUSFÜHRUNG	=	S2	
2			Bearb.			:	BIBERACH GmbH	Zeich-Nr.		4005-21369	+		Blatt	5+
1	Änderung	Datum	Name	Datum	Name		Copyright (c)				Ident Nr.			

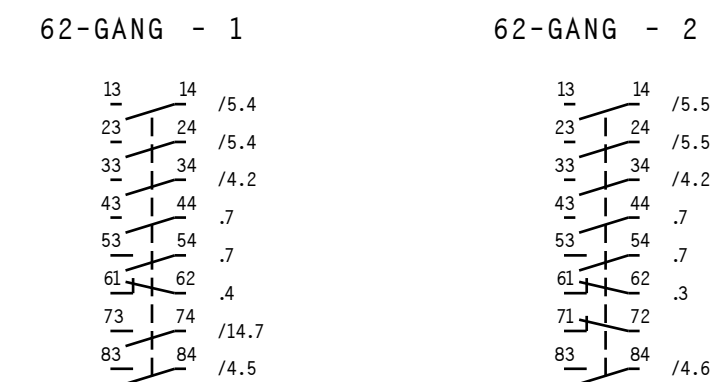
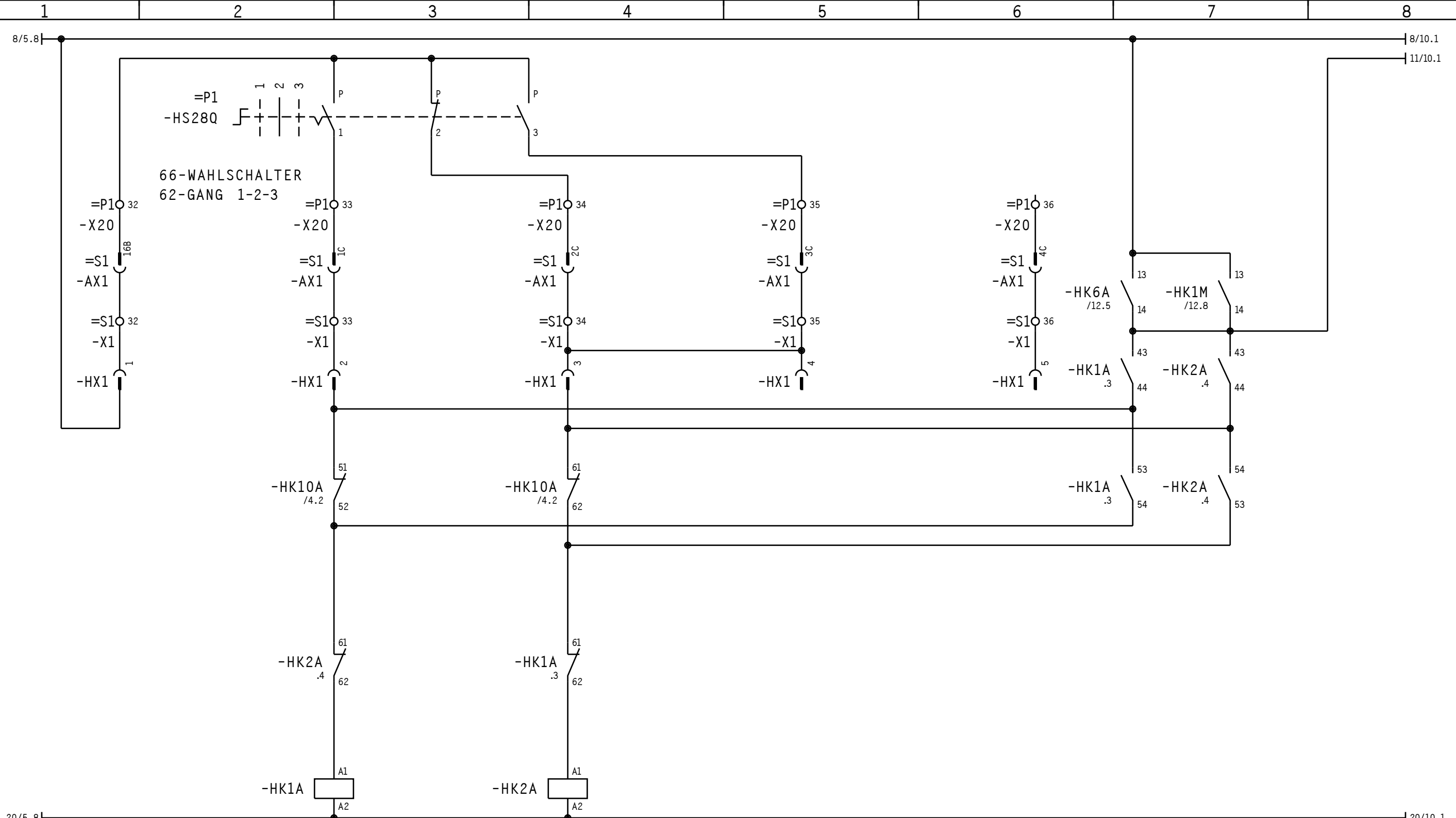

3			Gez.	31.08.09	ELLINGER	Maßstab	LIEBHERR-WERK	65-HUBWERKGETRIEBE	TYPE	HC+EC-H GB-AUSFÜHRUNG	=	S2
2			Bearb.			:	BIBERACH GmbH		Zeich-Nr.	4005-21369	+	Blatt
1	Änderung	Datum	Name	Datum	Name		Copyright (c)				Ident Nr.	

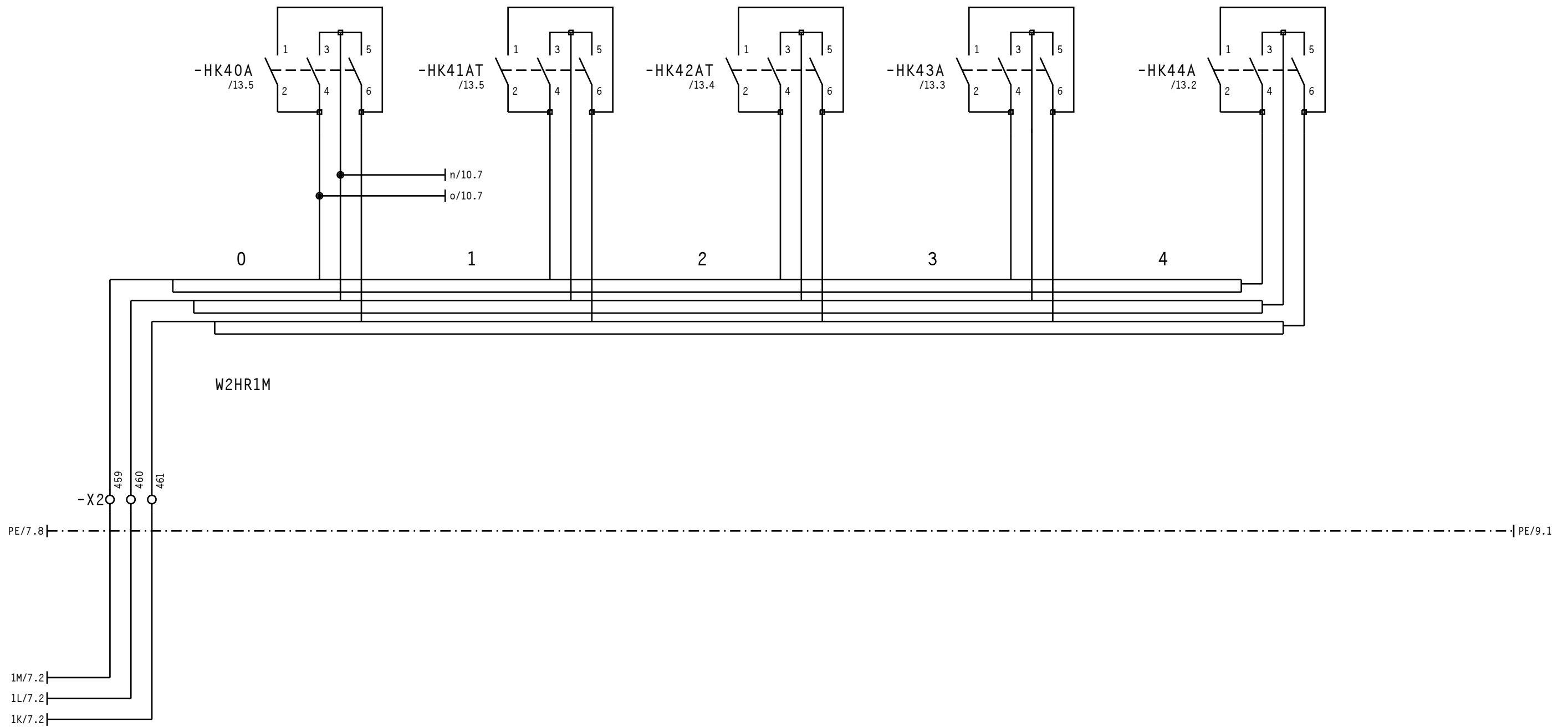

3			Gez.	31.08.09	ELLINGER		Maßstab	LIEBHERR-WERK	30-HUBWERK	TYPE	HC+EC-H GB-AUSFÜHRUNG	=	S2
2			Bearb.			:	BIBERACH GmbH	Zeich-Nr.		4005-21369	+		
1	Änderung	Datum	Name	Datum	Name		Copyright (c)				Blatt	8+	Ident Nr.

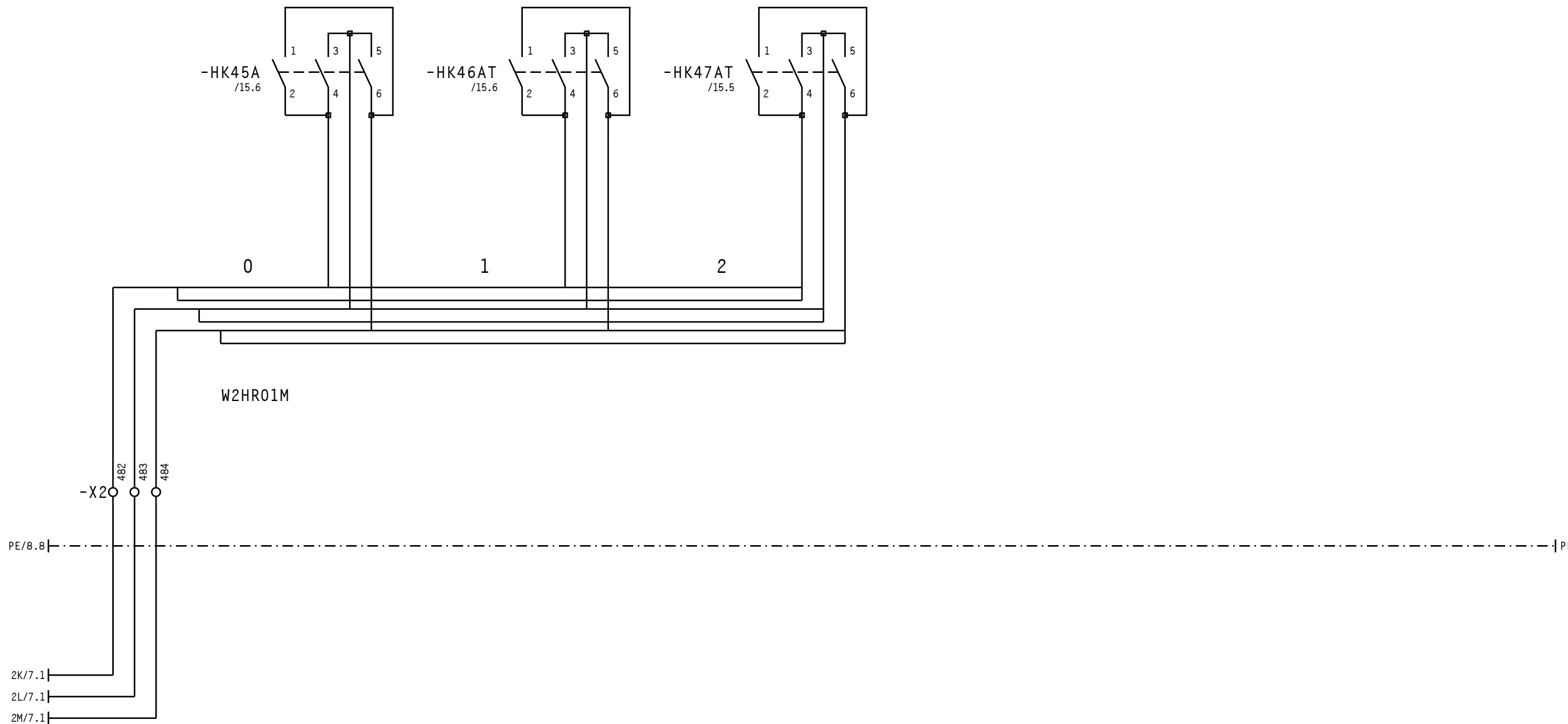

3			Gez.	31.08.09	ELLINGER		Maßstab	LIEBHERR-WERK	30-HUBWERK	TYPE	HC+EC-H GB-AUSFÜHRUNG	=	S2
2			Bearb.			:	BIBERACH GmbH	Zeich-Nr.		4005-21369	+		
1	Änderung	Datum	Name	Datum	Name		Copyright (c)				Blatt	9+	

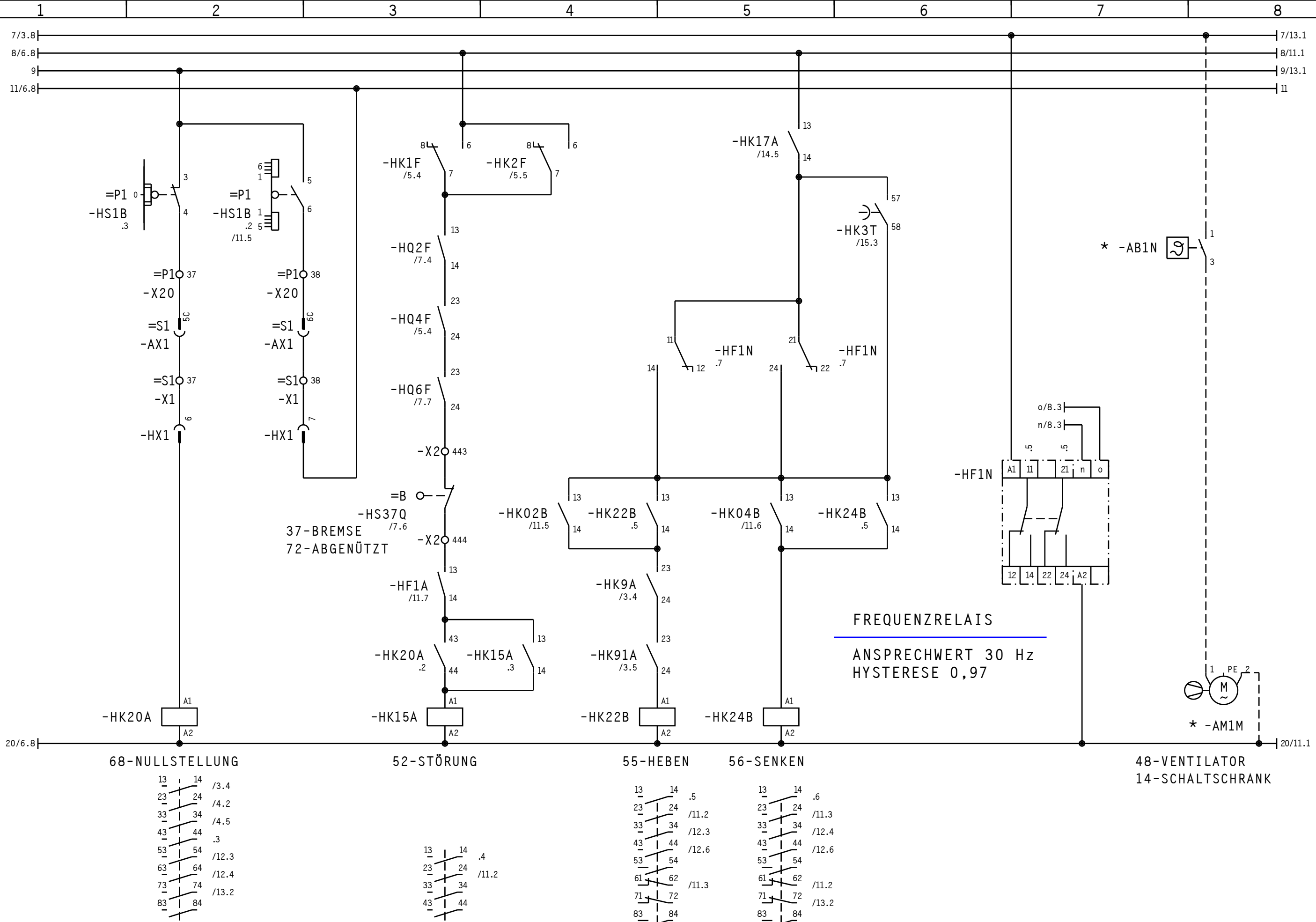

68-NULLSTELLUNG

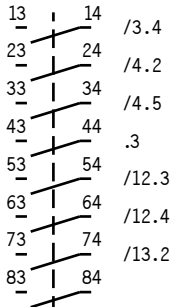

52-STÖRUNG

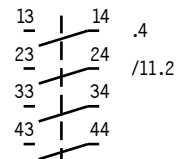

55-HEBEN

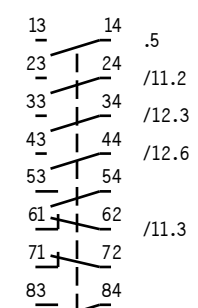

56-SENKEN

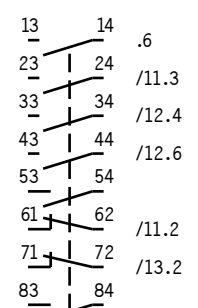

48-VENTILATOR
14-SCHALTSCHRANK

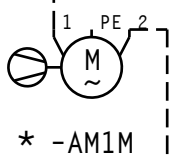

3			Gez.	31.08.09	ELLINGER	Maßstab	LIEBHERR-WERK	30-HUBWERK	TYPE	HC+EC-H GB-AUSFÜHRUNG	=	S2	
2			Bearb.			:	BIBERACH GmbH		Zeich-Nr.	4005-21369	+	Blatt	10+
1	Änderung	Datum	Name	Datum	Name		Copyright (c)					Ident Nr.	

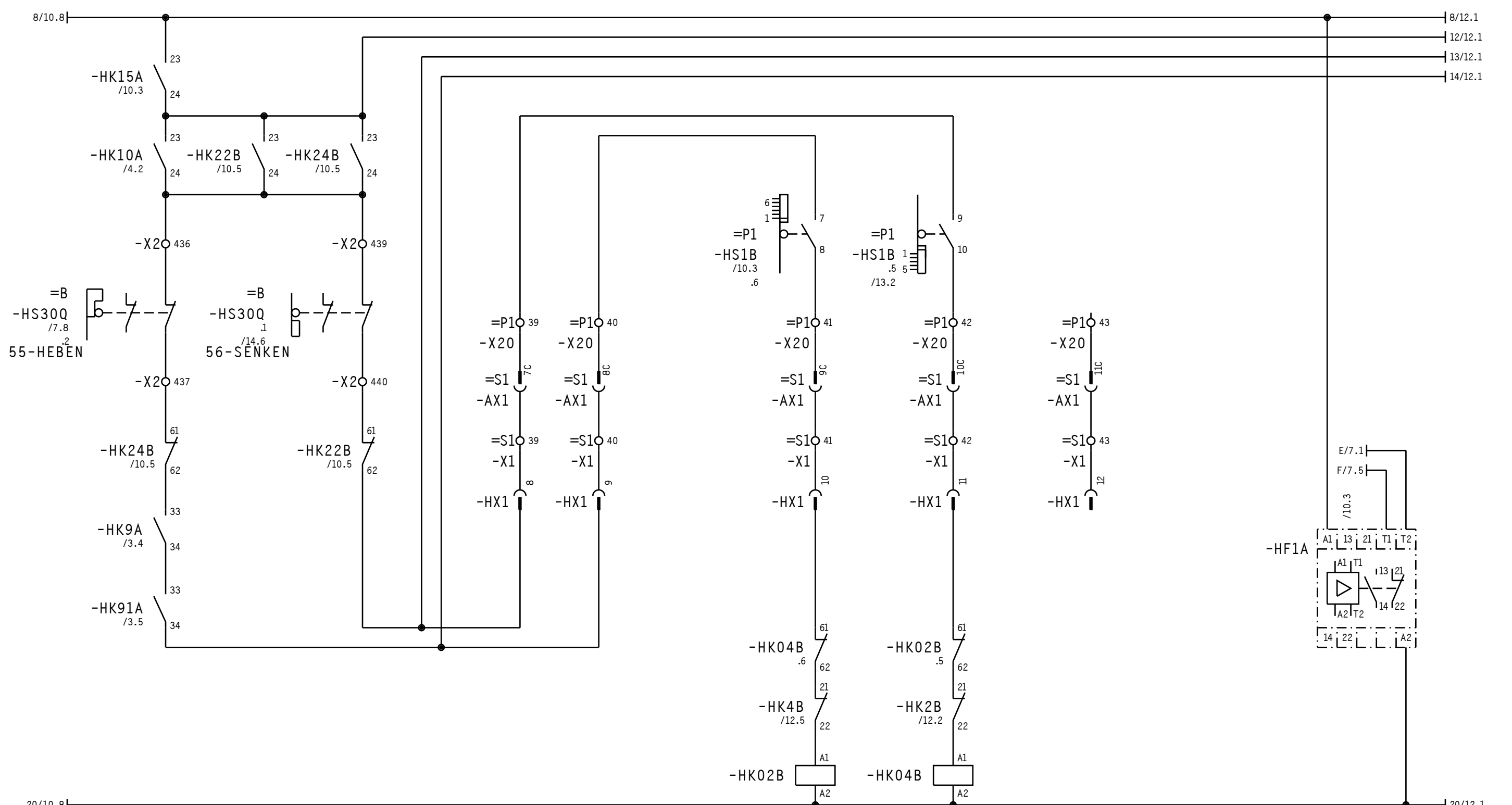

55-HEBEN 56-SENKEN

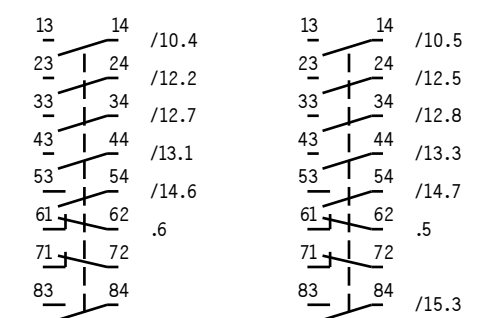

3			Gez.	31.08.09	ELLINGER	Maßstab	LIEBHERR-WERK	30-HUBWERK	TYPE	HC+EC-H GB-AUSFÜHRUNG	=	S2	
2			Bearb.			:	BIBERACH GmbH		Zeich-Nr.	4005-21369	+	Blatt	11+
1	Änderung	Datum	Name	Datum	Name		Copyright (c)					Ident Nr.	

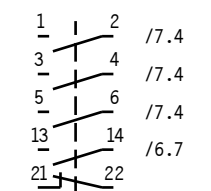
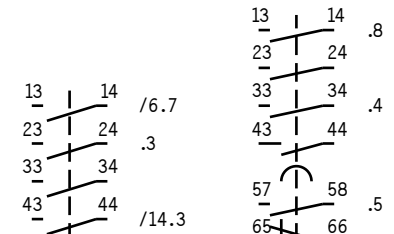
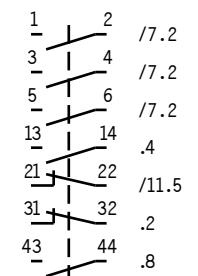
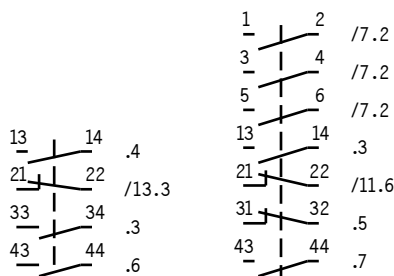
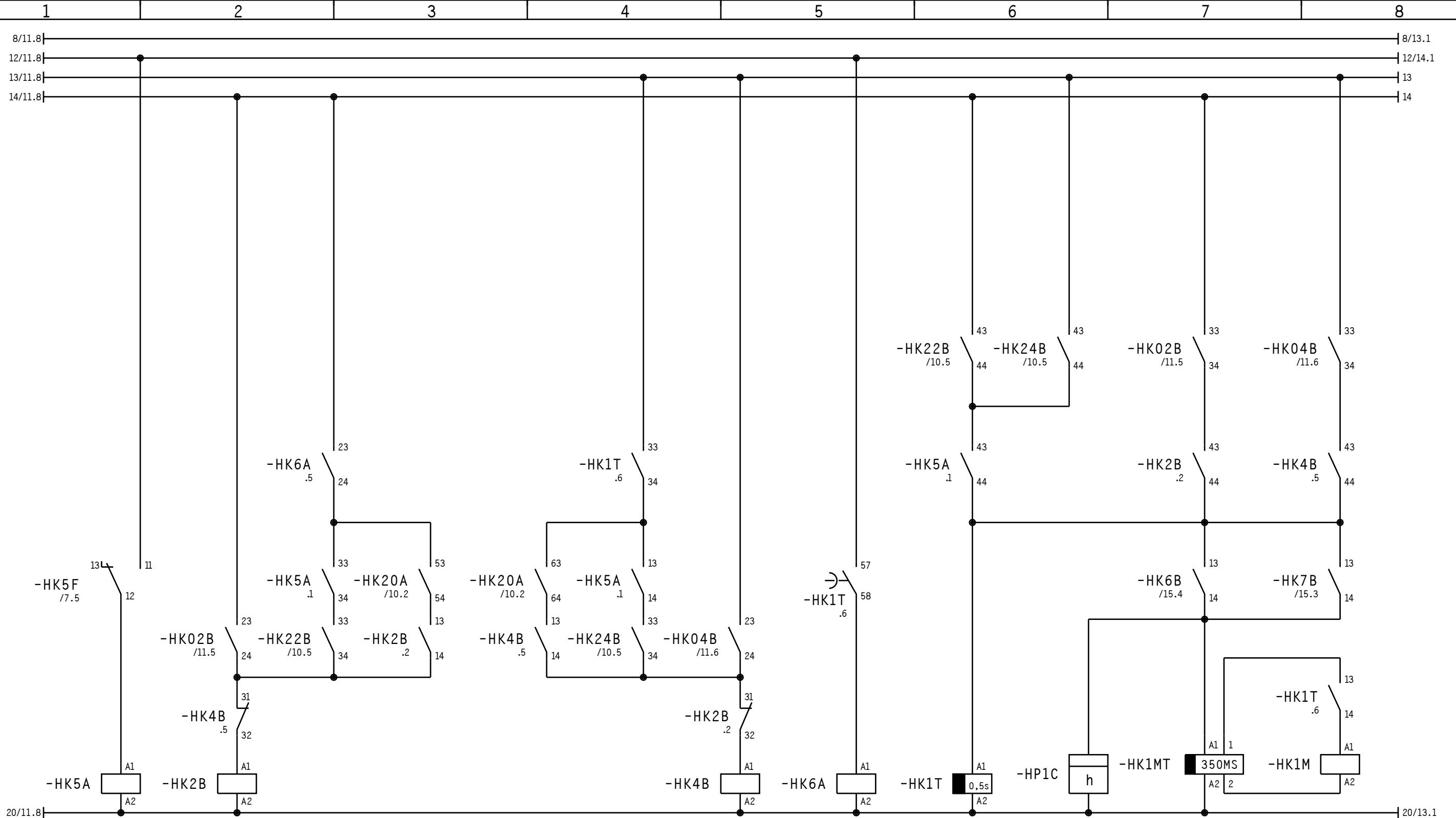

3			Gez.	31.08.09	ELLINGER		Maßstab	LIEBHERR-WERK	30-HUBWERK	TYPE	HC+EC-H GB-AUSFÜHRUNG	=	S2
2			Bearb.			:	BIBERACH GmbH	Zeich-Nr.		4005-21369	Blatt	12+	
1	BETRIEBSSTUNDENZÄHLER	29.01.91	ELLINGER				Copyright (c)				Ident Nr.		
	Änderung	Datum	Name	Datum	Name								

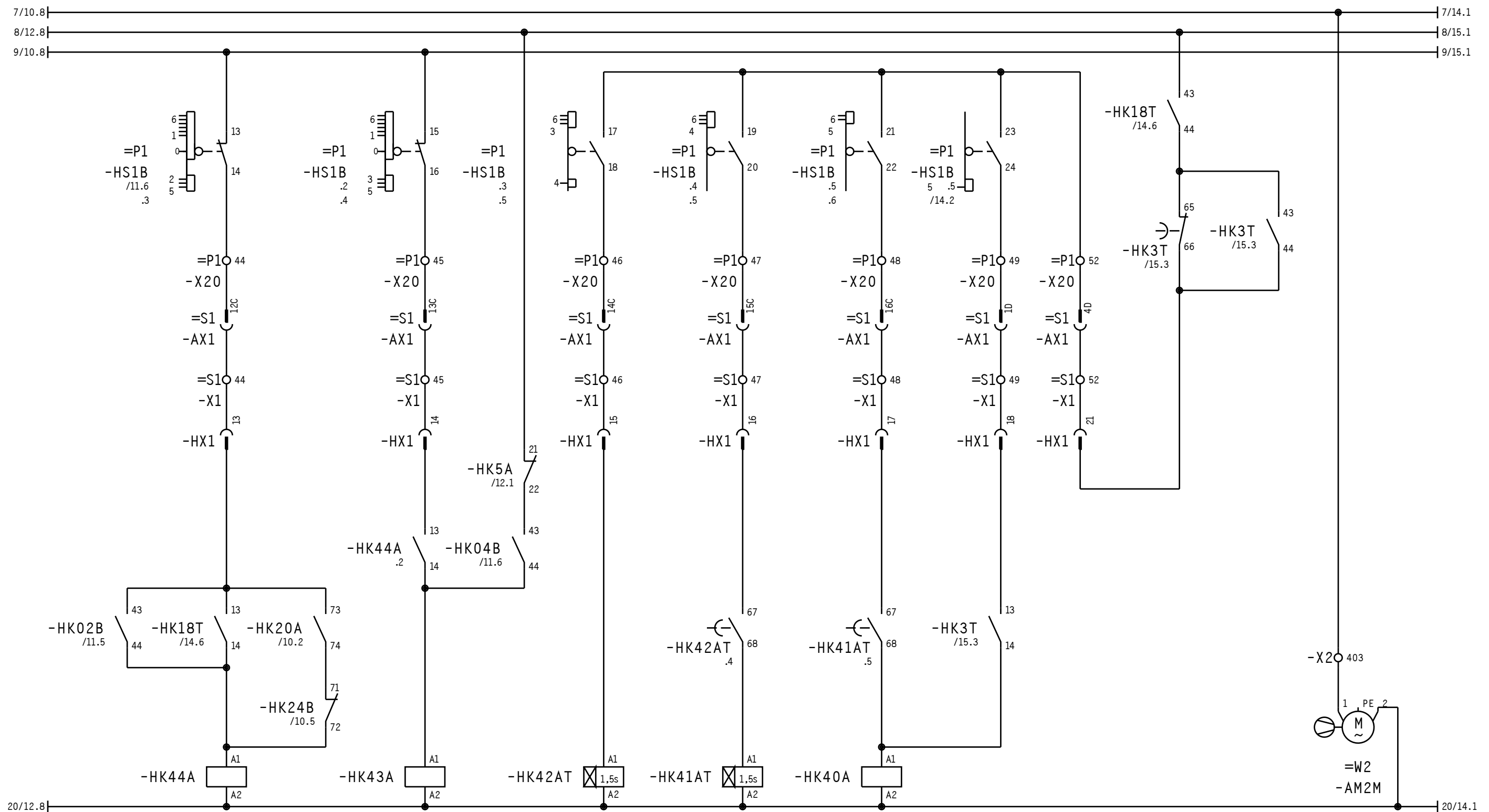

48-VENTILATOR
32-WIDERSTANDSSCHRANK

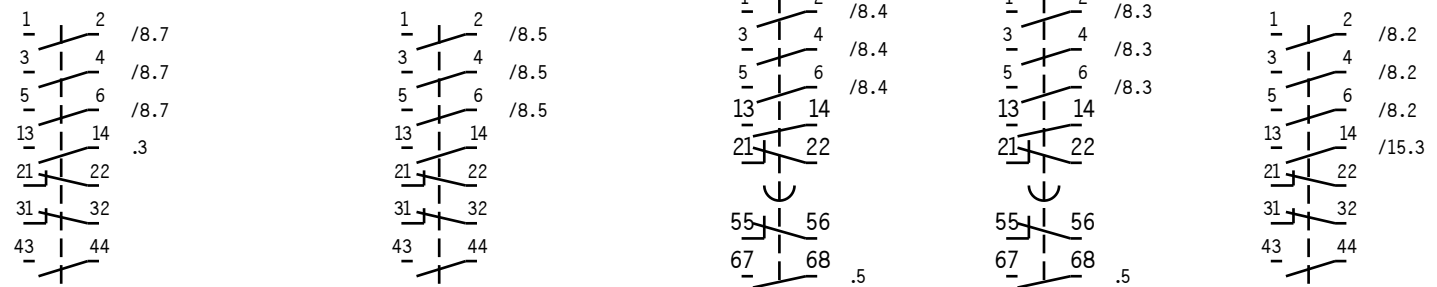

3			Gez.	31.08.09	ELLINGER	Maßstab	LIEBHERR-WERK	30-HUBWERK	TYPE	HC+EC-H GB-AUSFÜHRUNG	=	S2	
2			Bearb.			:	BIBERACH GmbH		Zeich-Nr.	4005-21369	+	Blatt	13+
1	Änderung	Datum	Name	Datum	Name		Copyright (c)					Ident Nr.	

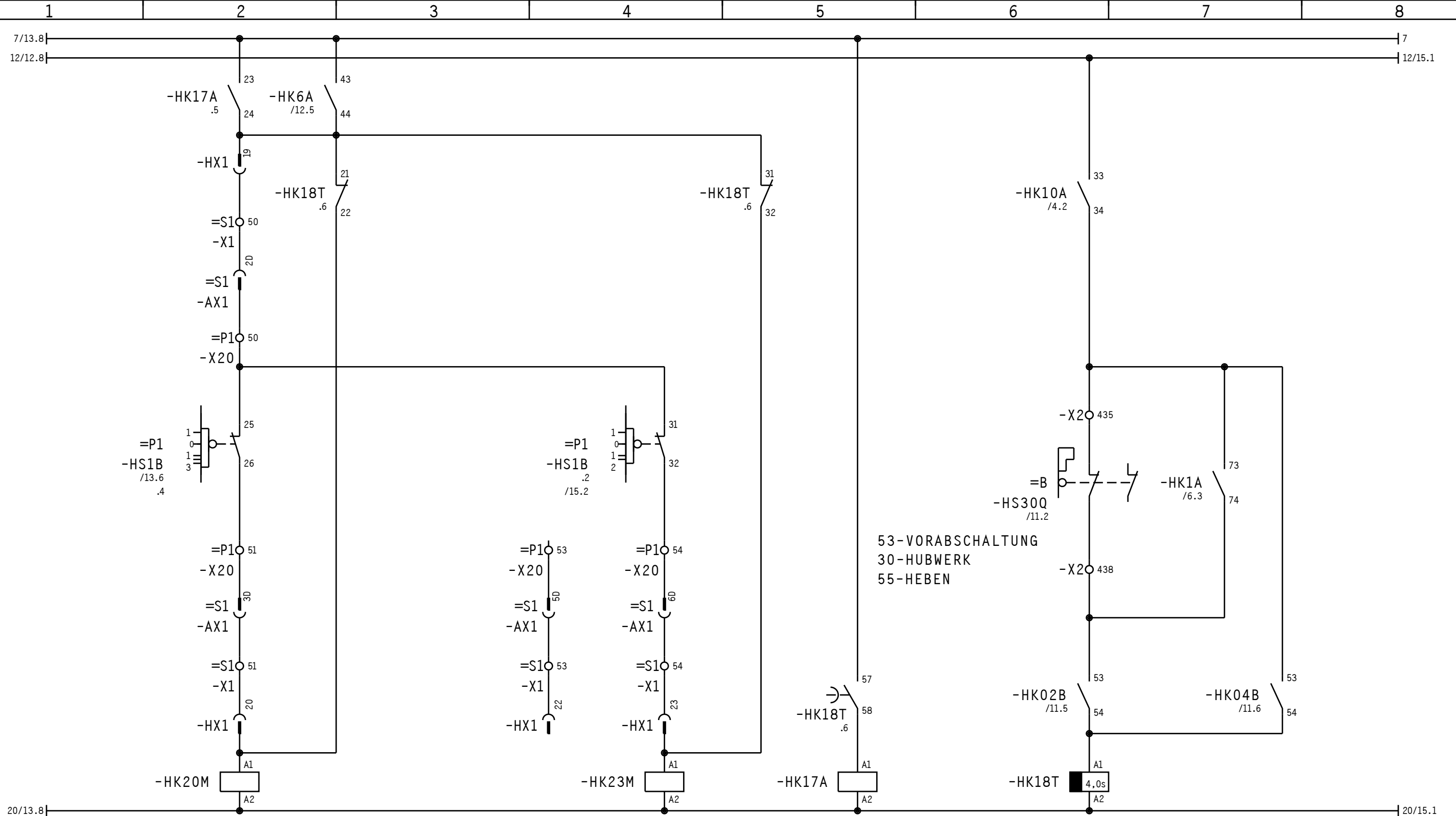

70-WIRBELSTROMBREMSE

53-VORABSCHALTUNG
30-HUBWERK
55-HEBEN

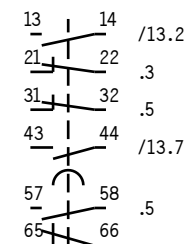
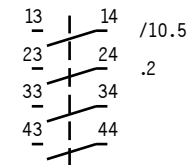
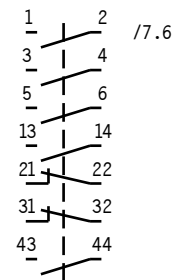
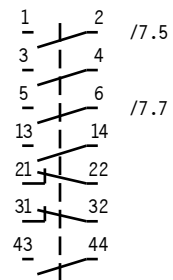

3			Gez.	31.08.09	ELLINGER		Maßstab	LIEBHERR-WERK	30-HUBWERK	TYPE	HC+EC-H GB-AUSFÜHRUNG	=	S2	
2			Bearb.			:	BIBERACH GmbH	Zeich-Nr.		4005-21369	+		Blatt	14+
1	Änderung	Datum	Name	Datum	Name		Copyright (c)						Ident Nr.	

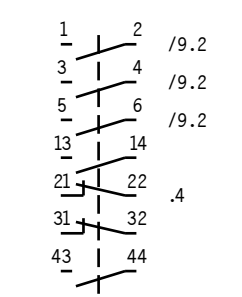
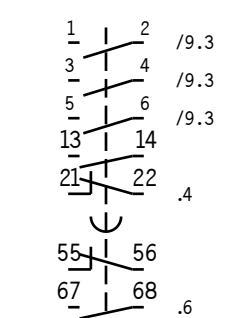
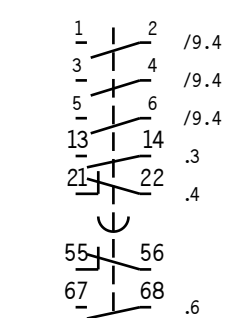
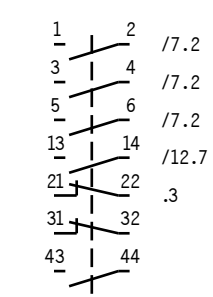
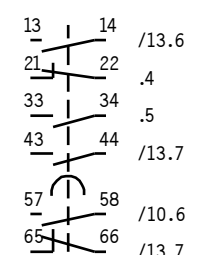
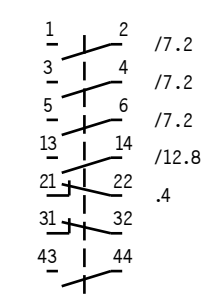
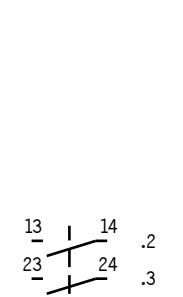
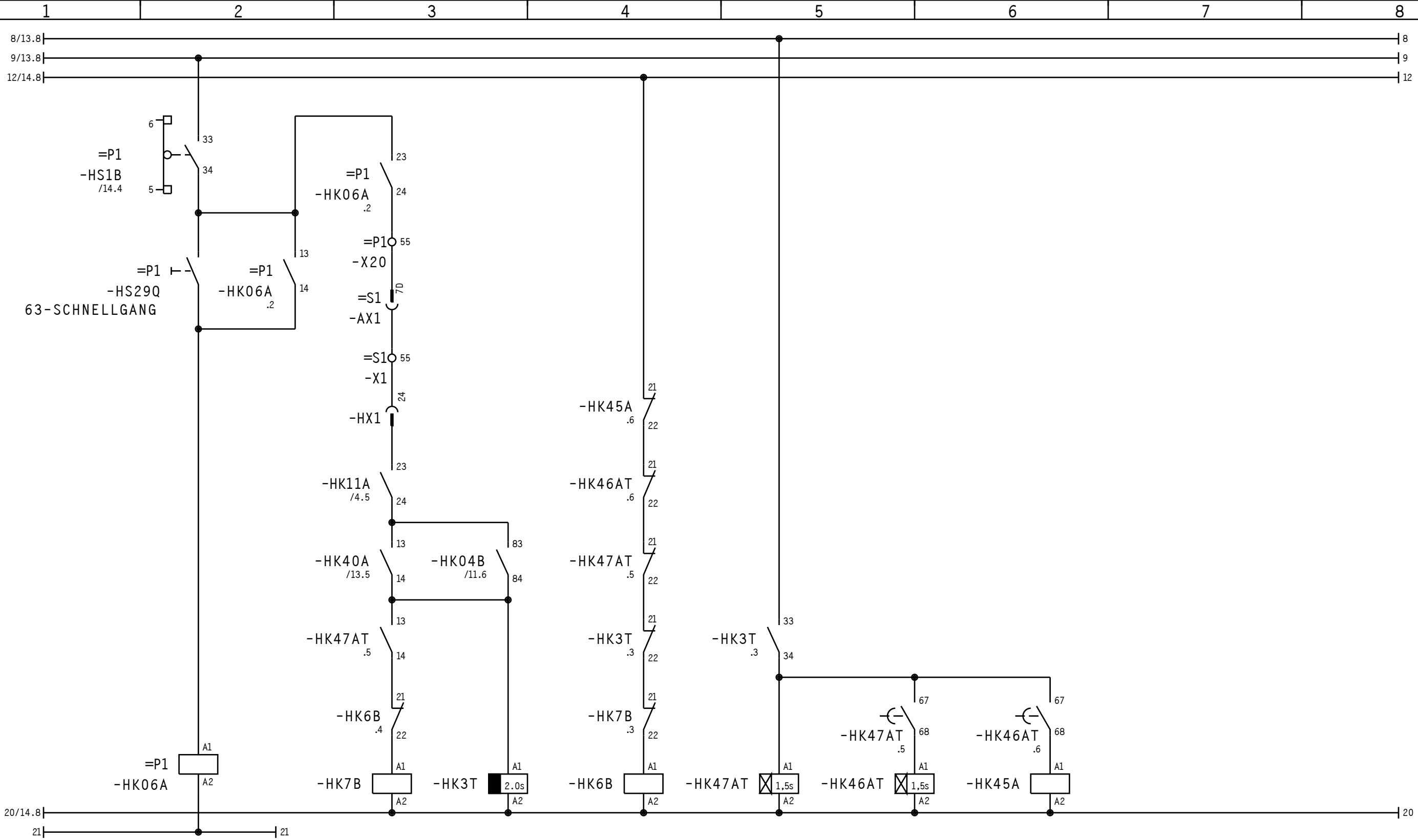

3			Gez.	31.08.09	ELLINGER		Maßstab	LIEBHERR-WERK	30-HUBWERK	TYPE	HC+EC-H GB-AUSFÜHRUNG	=	S2	
2			Bearb.			:	BIBERACH GmbH	Zeich-Nr.		4005-21369	+		Blatt	15-
1	Änderung	Datum	Name	Datum	Name		Copyright (c)				Ident Nr.			