

* Schaltstrombetätigung
Switchgear panel for
ventilation de l'armoire électrique
Etskáp ventilátion~

Hauptkontaktor
Contactor principal
Main contactor

Gruppe: Hauptschütz
Zusatz Nr. 40 05 21323 Blatt 2 von 17

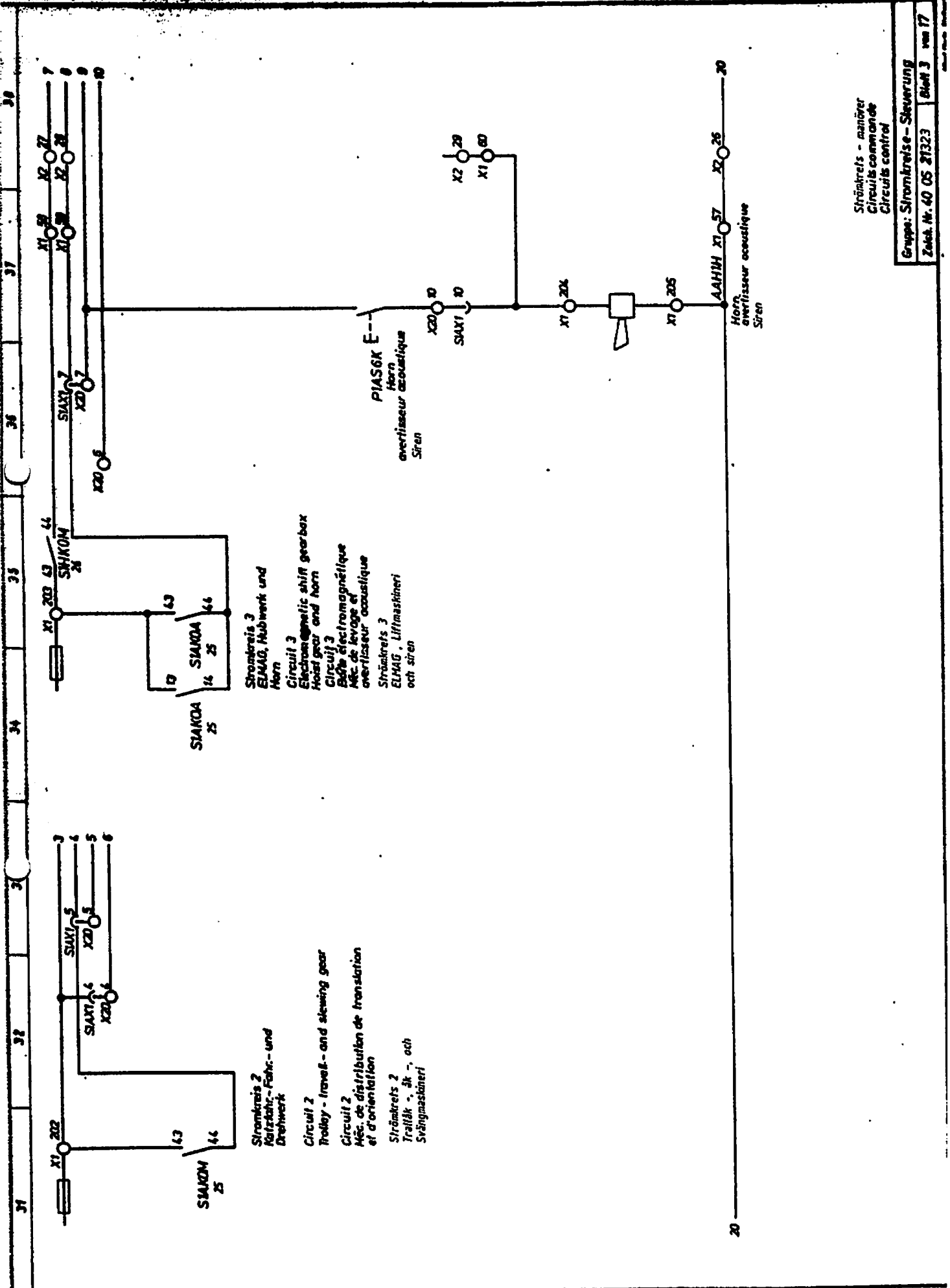

Strömkreis - manövrer
 Circuit's commande
 Circuit's control

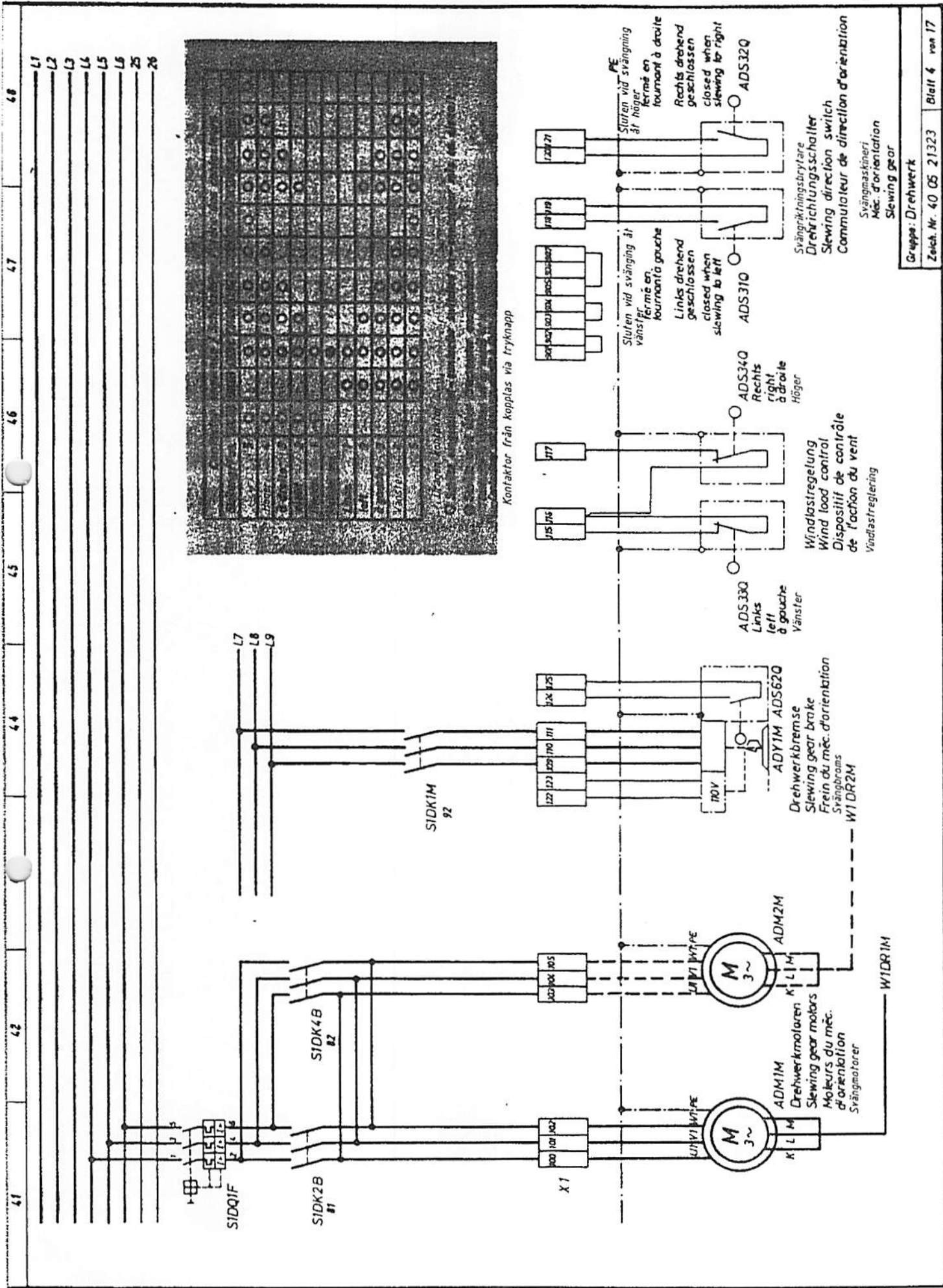

Kontaktor från kopplas via tryknapp

Svängningsbrytare
 Drehrichtungsschalter
 Slewing direction switch
 Commutateur de direction d'orientation

Svängningsmaskineri
 Mec. d'orientation
 Slewing gear

31 32 33 34 35 36 37 38

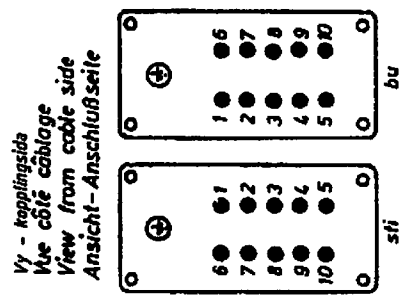

WIndfreistellung -
 Drehwerkbremse auf
 Crane turns freely
 into the wind -
 slewing gear brake is released
 Mise en girouette -
 frein d'orientation débloqué
 Windfreistellung

Svängmaskineri
 Mec. d'orientation
 Slewing gear

61	62	64	65	66	67	68
U1						
U2						
U3						
U4						
U5						
U6						
U7						
U8						
U9						
U10						

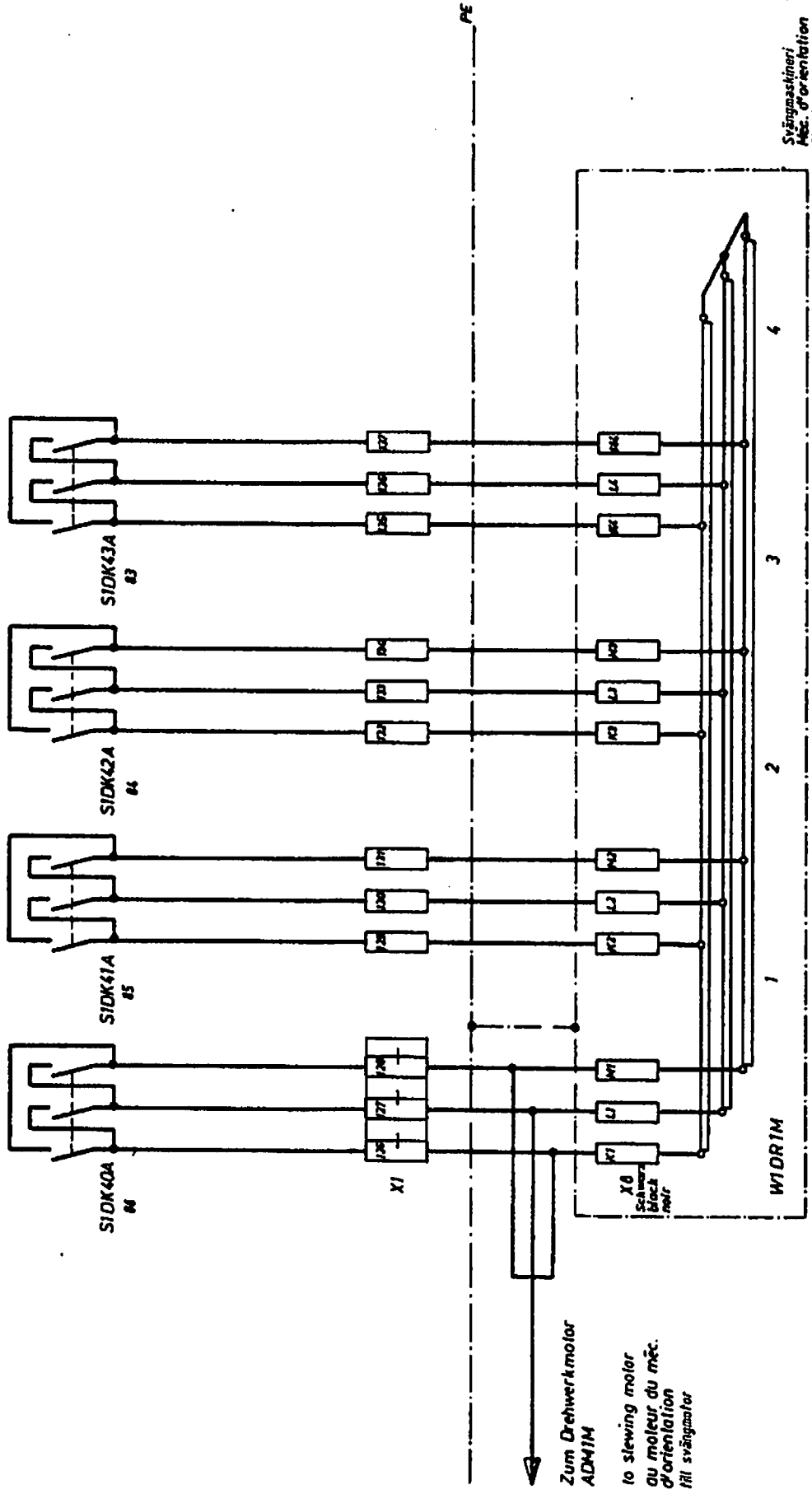

Zum Drehwerkmotor
ADM1M
to slewing motor
ou moteur du mât.
d'orientation
fil svängmotor

Widerstandsschrank / Resistor box / Armoire à résistances
Motståndsskåp

Svängmaskineri
Mät. d'orientation
Slewing gear

Gruppe: Drehwerk
Zeich. Nr. 40 05 21323 Blatt 6 von 17

71	72	74	75	76	77	78
U						
L2						
L3						
L4						
L5						
L6						
Z5						
Z6						

Wenn diese Schütze im Schaltschrank eingebaut sind,
sind dieselben zu verdrängen

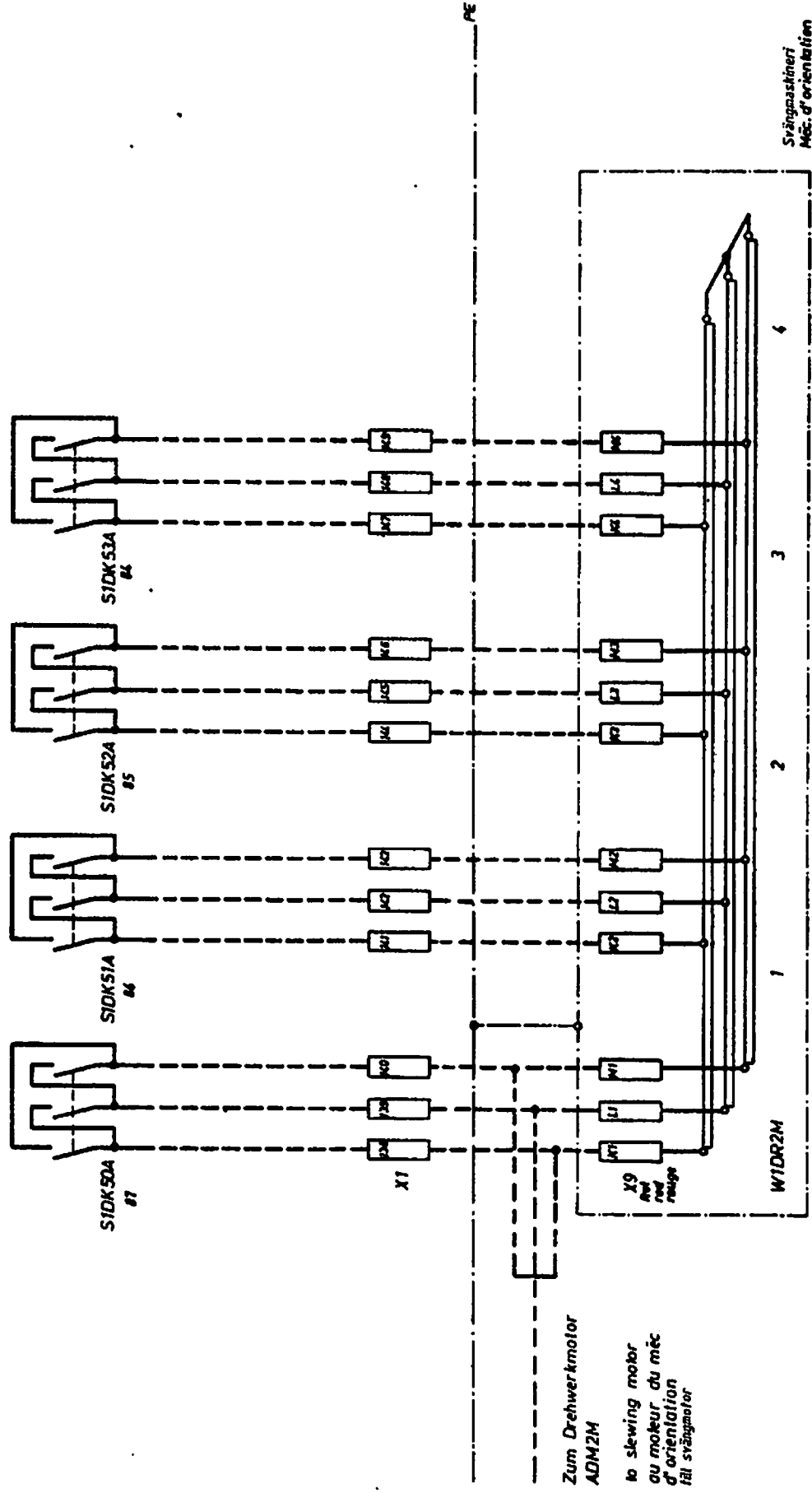

Zum Drehwerkmotor
ADM2M
to slewing motor
ou moteur du m^c
d'orientation
tilt stängmotor

Widerstandsschrank / Resistor box / Armoire à résistances
Motståndsskåp

Svängsmotor
M^c: d'orientation
Slewing gear

These drawings are the entire responsibility of the designer and are not to be used for other purposes without the written consent of the designer. (Inventor's mark of 8. 9. 1965)

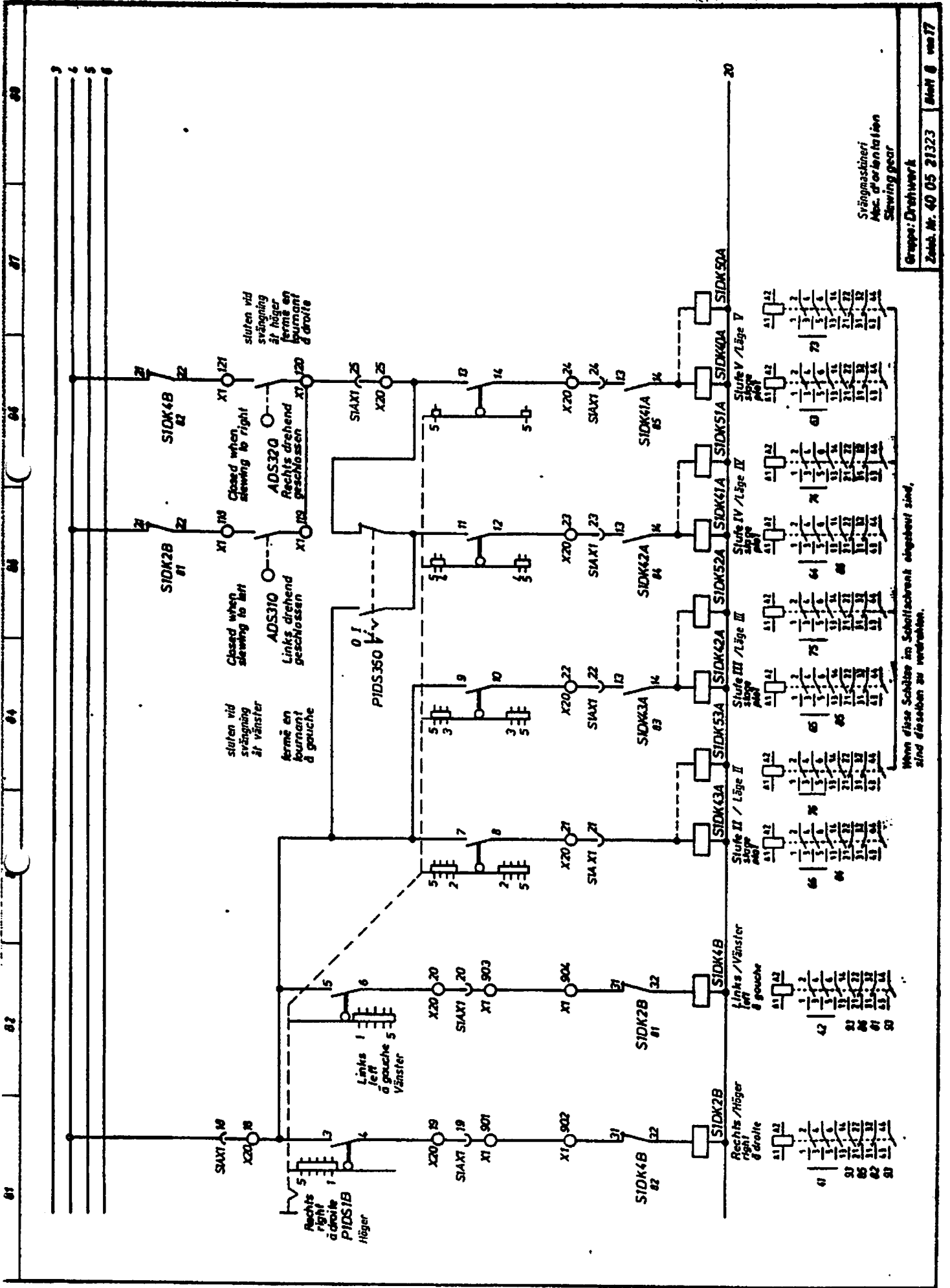

Svängmaskineri
 Mec. d'orientation
 Slewing gear

Gruppe: Drehwerk
 Zeich. Nr. 40 05 21323 Blatt 8 von 17

Wenn diese Schütze im Schaltkreis eingeschaltet sind,
 sind dieselben zu verriegeln.

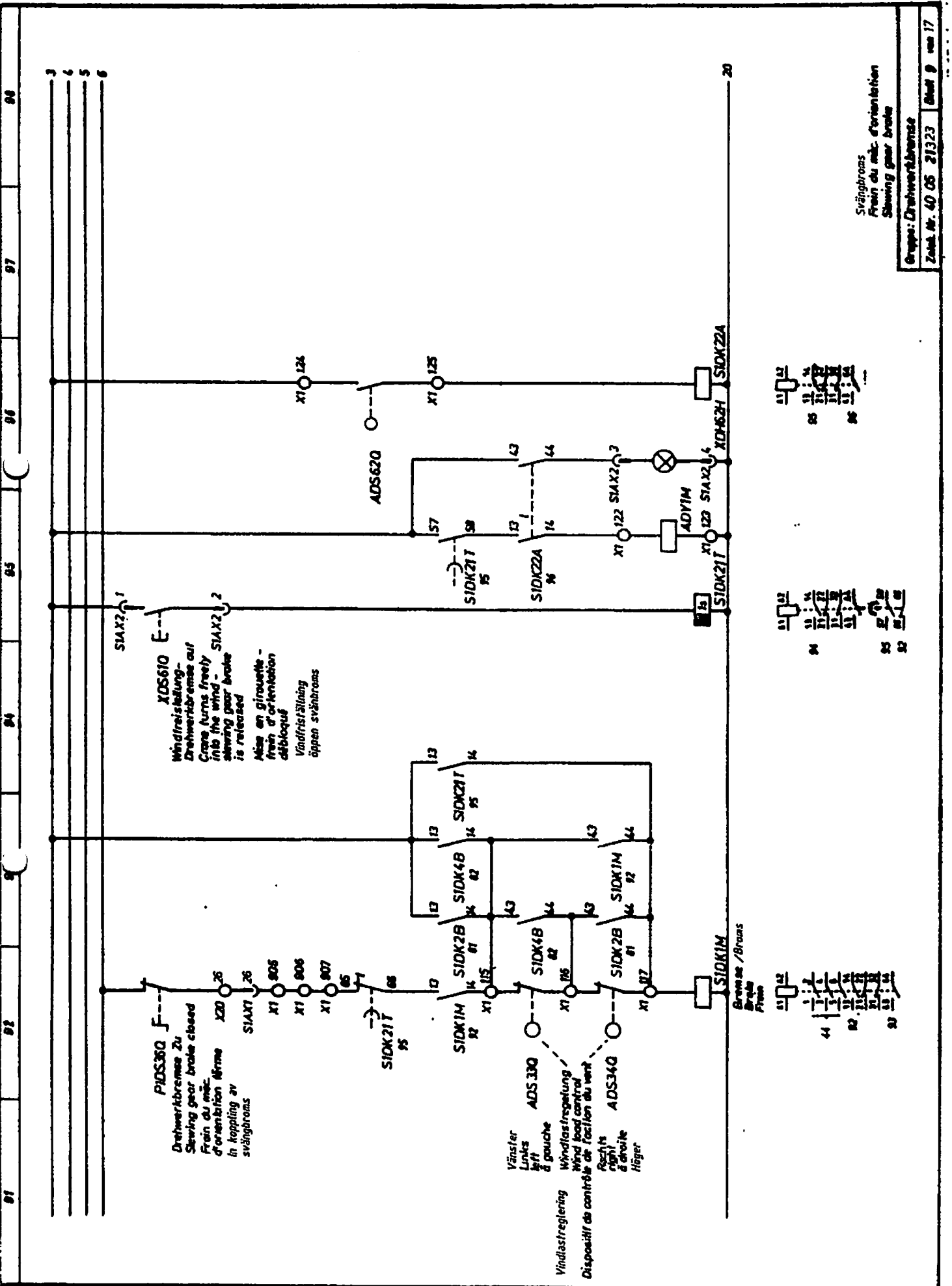

Svängbroms
 Frein du méc. d'orientation
 Steering gear brake

Gruppe: Drehwerkbremse
 Zeich. Nr. 40 OS 21323 Blatt 9 von 17

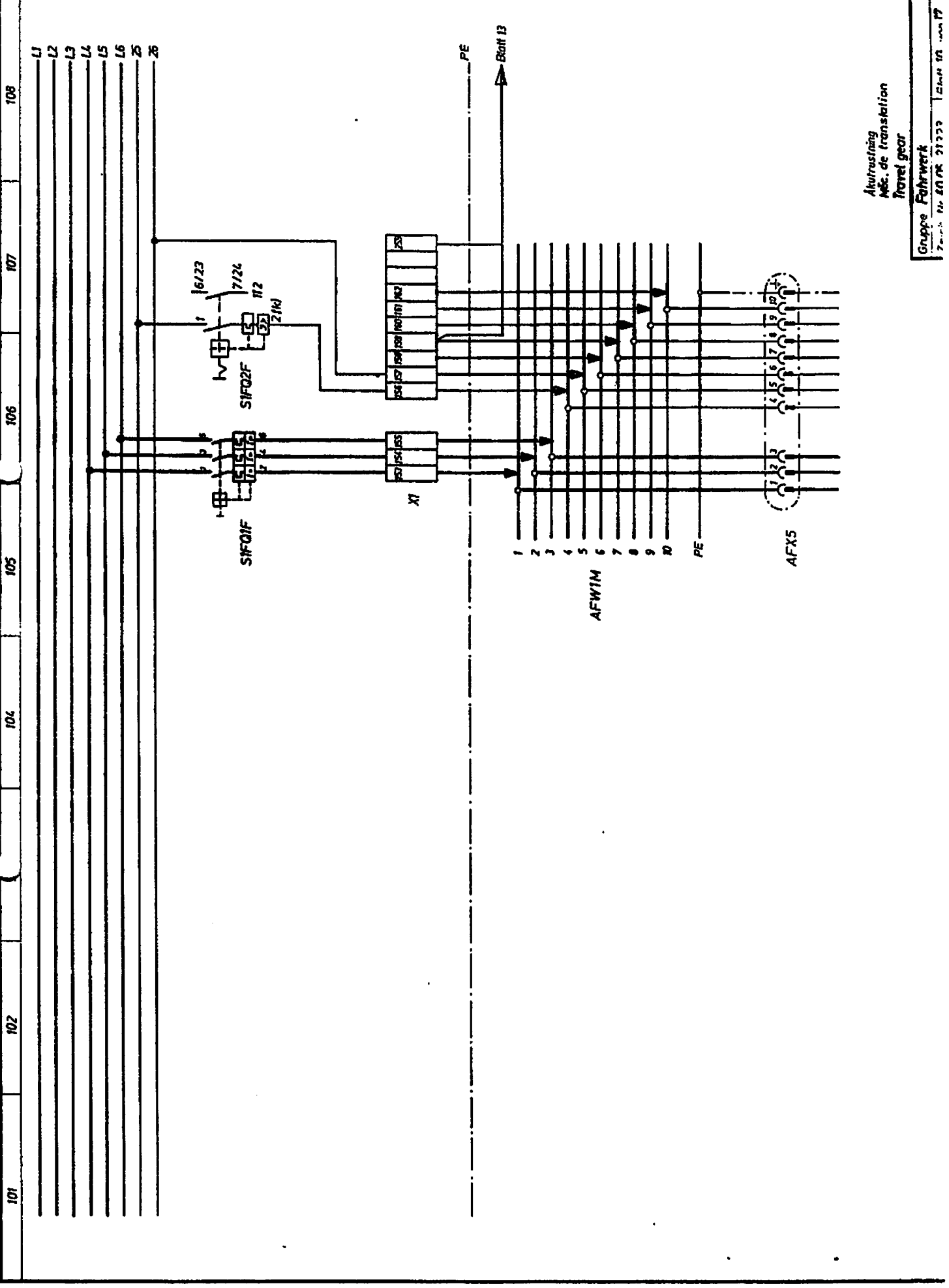

Aktivering
Mec. de transmissie
Travel gear

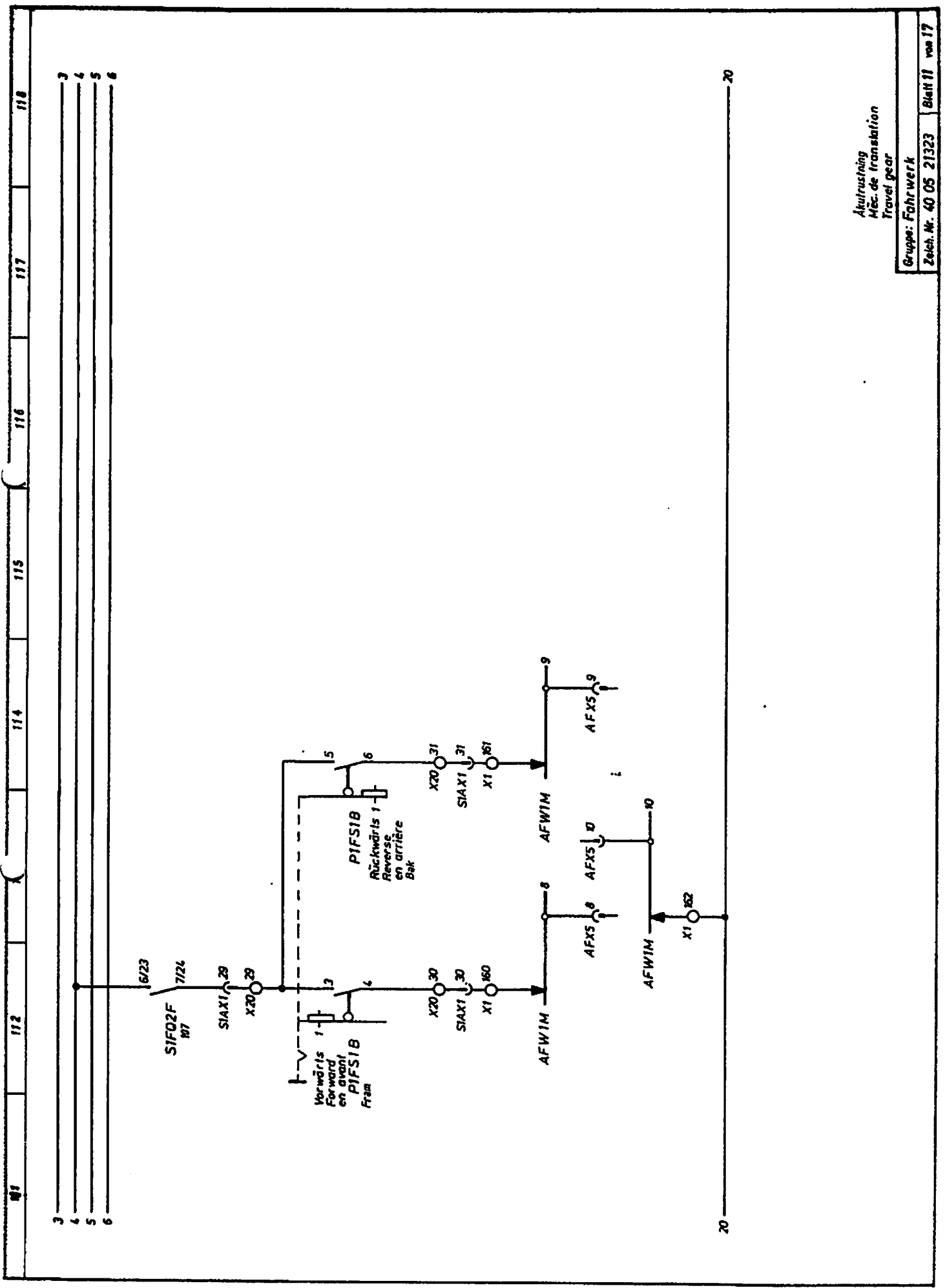

- 3
- 4
- 5
- 6

112 114 115 116 117 118

20 20

121	122	124	125	126	127	128
L1						
L2						
L3						
L4						
L5						
L6						
ZS						
Z6						

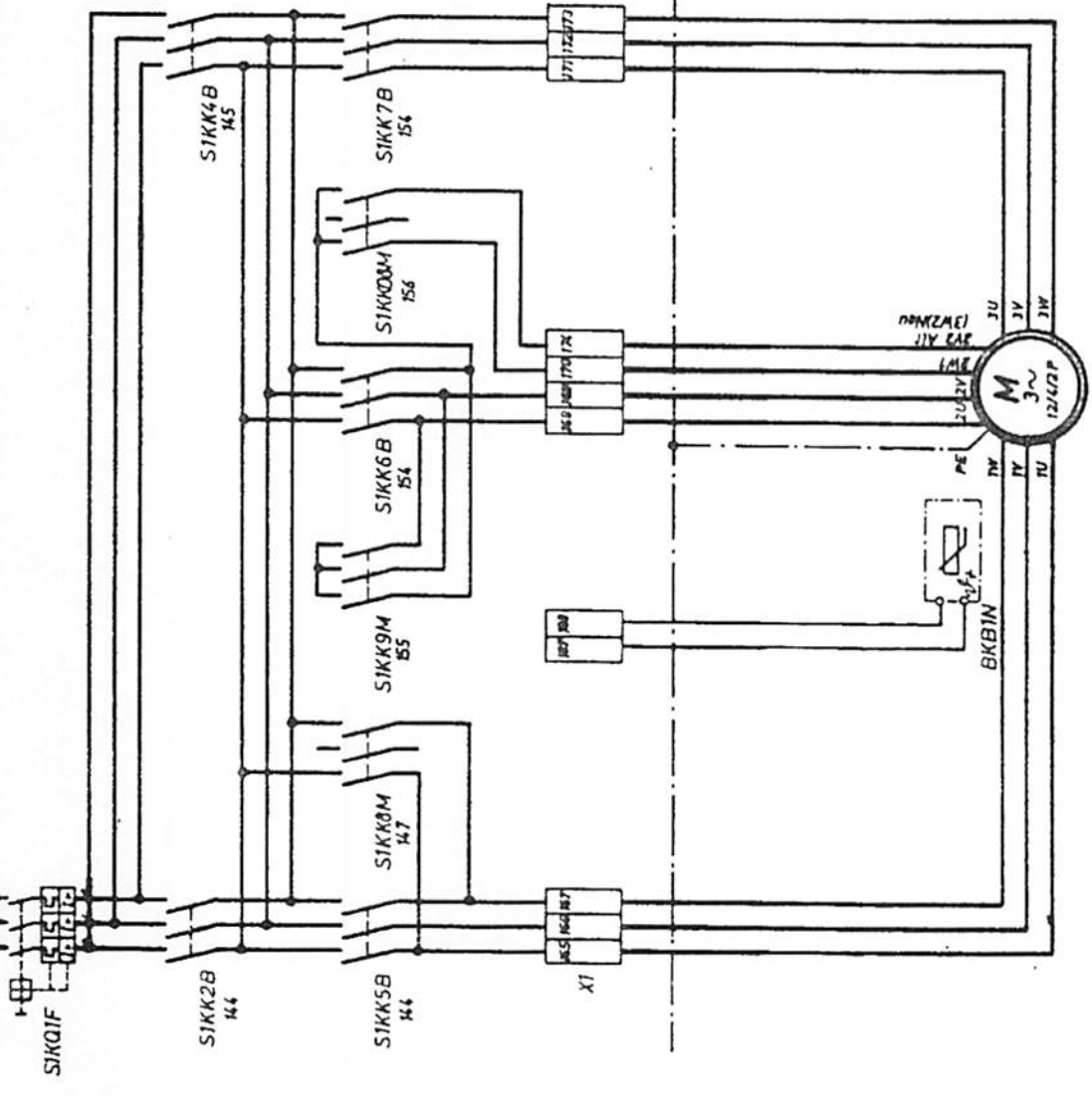
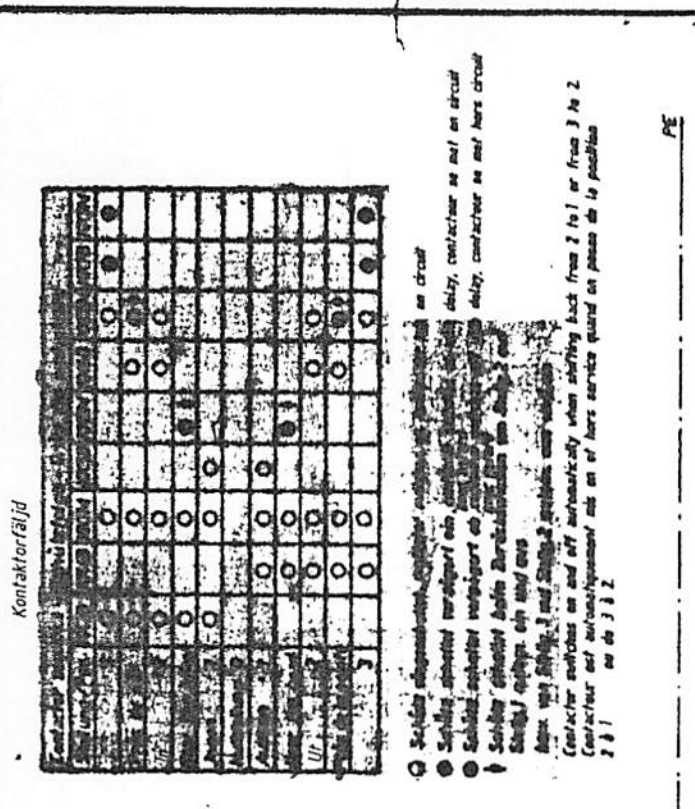

BKMI1M
 Katzfahrwerk motor / Trolley travel gear motor
 Moteur du méc. de distribution

Trailläkmastineri
 Méc. de distribution
 Trolley travel gear

Gruppe: Katzfahrwerk
 Zeich. Nr. 40 05 21323
 Blatt 12 von 17

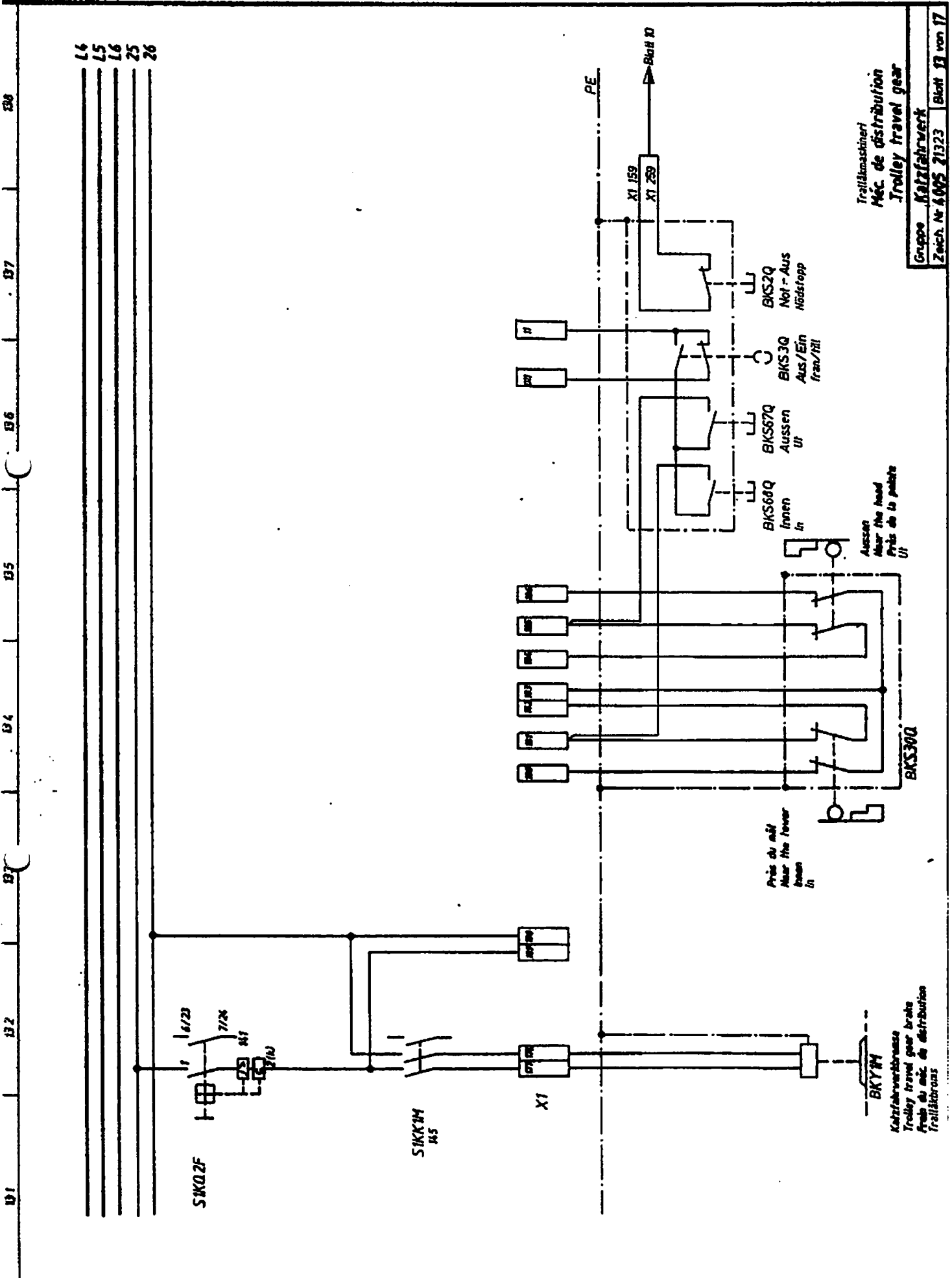

Trollmaskineri
 Mec. de distribution
 Trolley travel gear

Gruppe **Katzfahrwerk**
 Zeich. Nr. **A005 21323** Blatt **33** von **17**

14
 15
 16
 25
 26

191 192 194 195 196 197 198

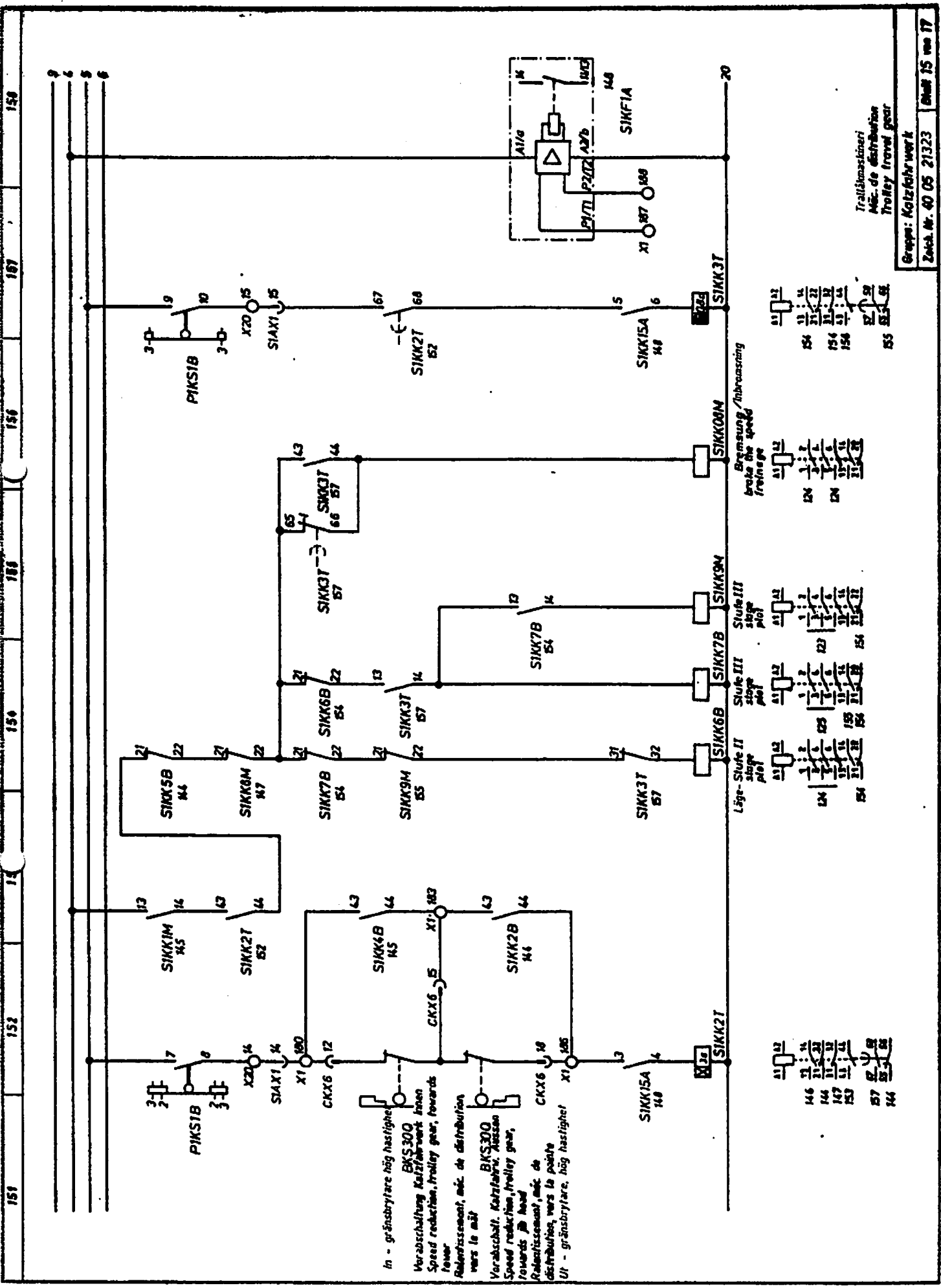

1. 2. 3. 4. 5. 6. 7. 8. 9. 10. 11. 12. 13. 14. 15. 16. 17. 18. 19. 20. 21. 22. 23. 24. 25. 26. 27. 28. 29. 30. 31. 32. 33. 34. 35. 36. 37. 38. 39. 40. 41. 42. 43. 44. 45. 46. 47. 48. 49. 50. 51. 52. 53. 54. 55. 56. 57. 58. 59. 60. 61. 62. 63. 64. 65. 66. 67. 68. 69. 70. 71. 72. 73. 74. 75. 76. 77. 78. 79. 80. 81. 82. 83. 84. 85. 86. 87. 88. 89. 90. 91. 92. 93. 94. 95. 96. 97. 98. 99. 100.

In - gränsbrytare hög hastighet
 BKS 300
 Vorabschaltung Kalzfahrwerk innen
 Speed reduction, trolley gear, forwards
 Relaiscontact, mé. de distribution
 vers le mât
 Vorabschalt. Kalzfahrw. Aussen
 Speed reduction, trolley gear,
 forwards jib head
 Relaiscontact, mé. de
 distribution, vers la pointe
 d'acier
 UI - gränsbrytare, hög hastighet

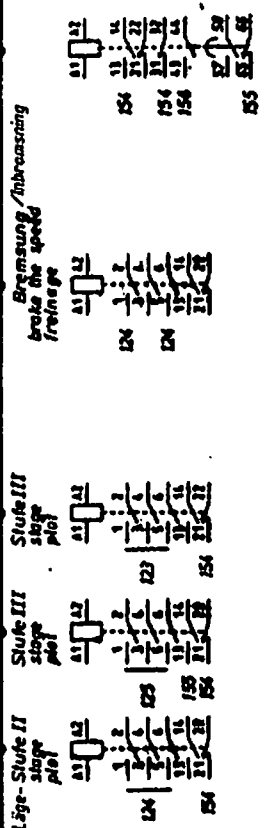

Trillmaskineri
 Mä. de distribution
 Trolley travel gear

Grupp: Kalzfahrwerk
 Zeich. Nr. 40 05 21323 Blatt 15 von 17

nach vorrätigkeit, nach Dritten eingetragene Patente vorbehalten
 Konstruktion des Vertriebs netzes, (Umschaltungs vom 9. 9. 1965)

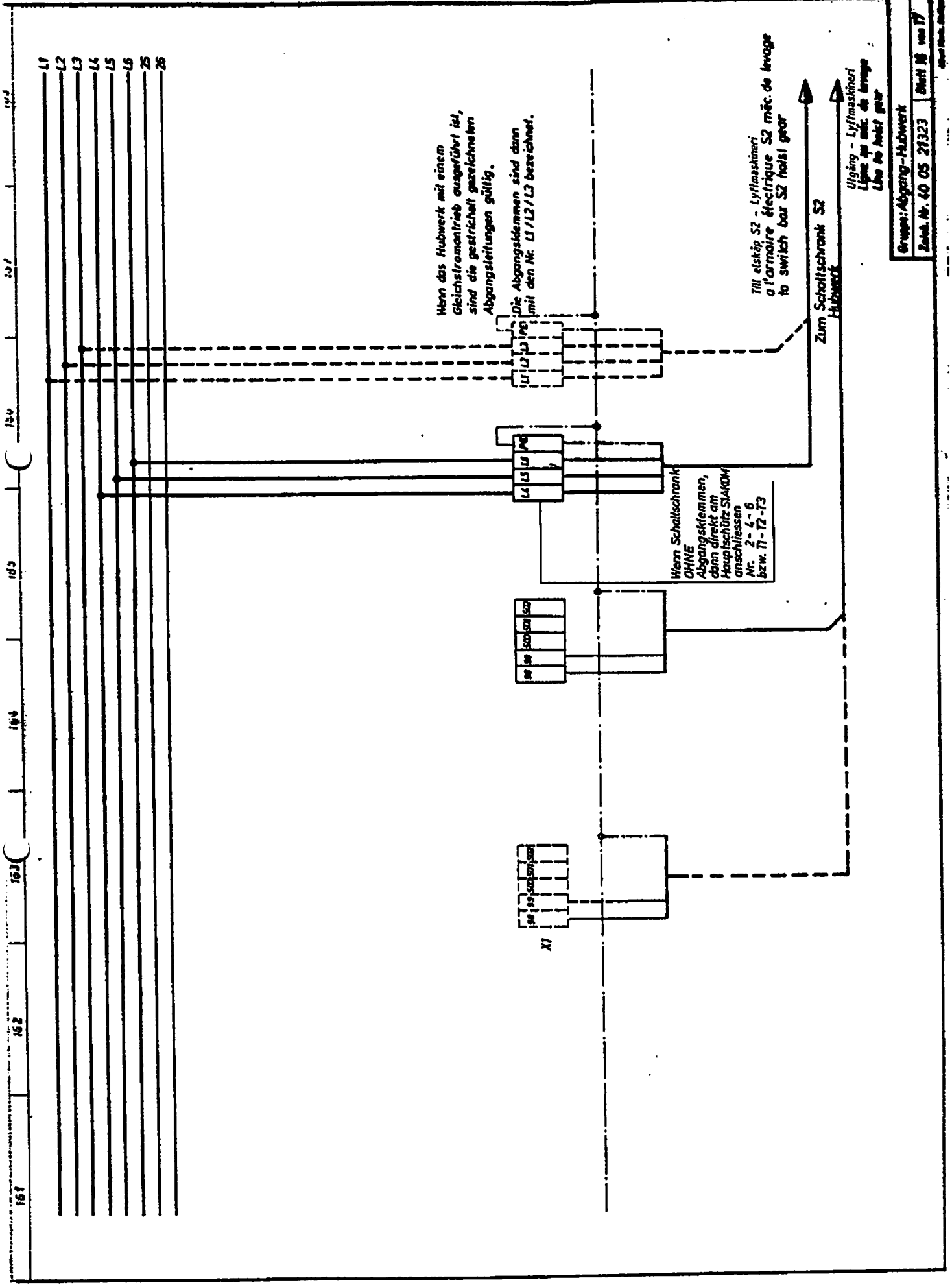

Gruppe: Abgang-Hubwerk
Zusatz Nr. 40 05 21323 Blatt 18 von 17

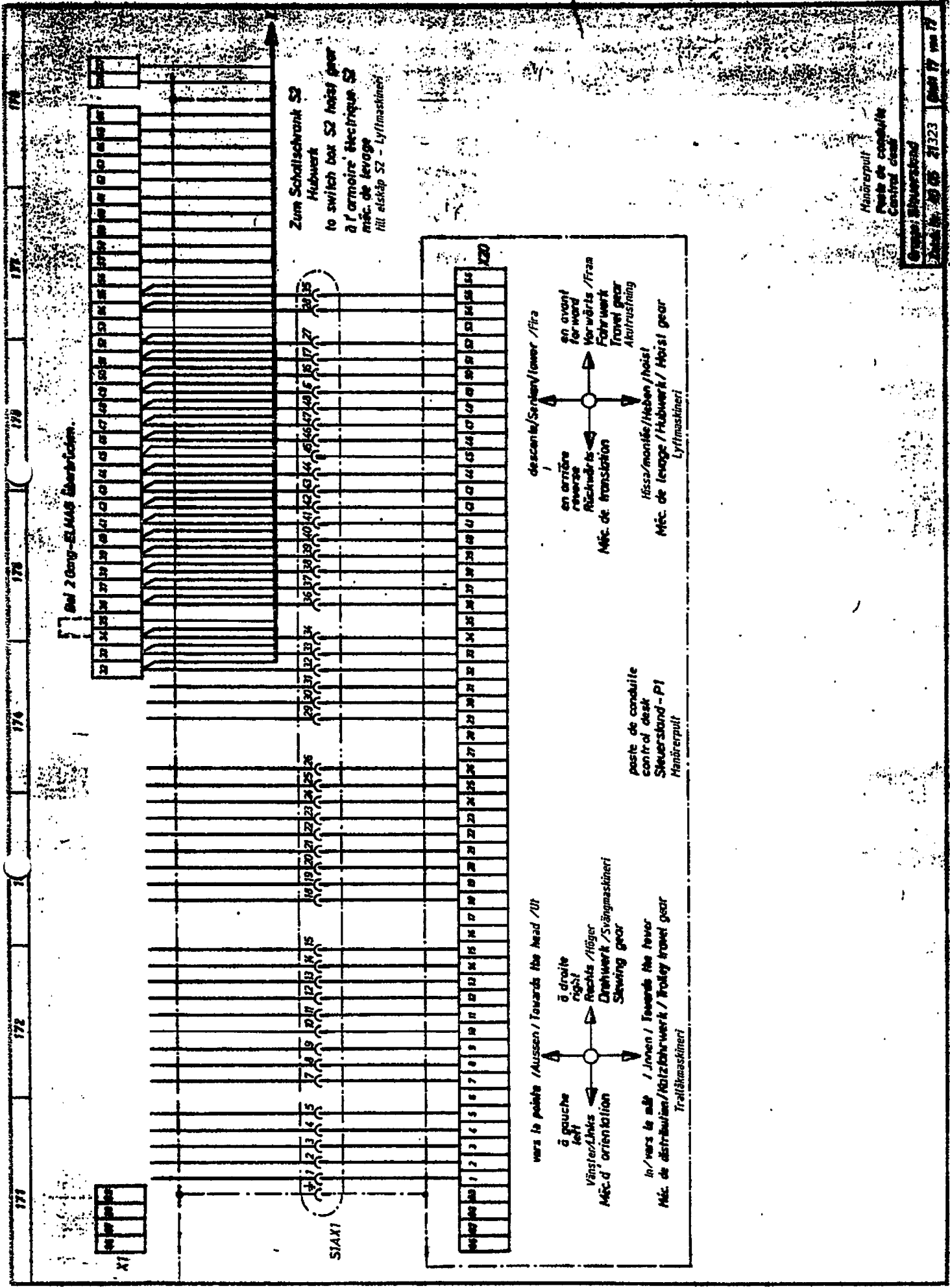

Zum Schaltwerk S2
Hubwerk
to switch box S2 hoist gear
à l'armoire électrique S2
méc. de levage
lift skíp S2 - Liftmaschinen

descents/Serien/toner /fira
en avant
forward
Vorwärts /Fira
Fahrgew
travel gear
Abfahrstung
Méc. de translation
Méc. de levage /Hubwerk / Hoist gear
Liftmaschinen

vers le pointe /Aussen / Towards the head /Ut
à droite
right
Rechts /l'ouer
Drehwerk /Svängsmasineri
Swing gear
In /vers le mât / Innen / Towards the tower
Méc. de distribution/ Holzfahrwerk / Trolley travel gear
Trailsämasineri

poste de conduite
control desk
Steuerstand - P1
Manöerpult

Manöerpult
Poste de conduite
Control desk

Grande-Bretagne
Date: 19 05 21323 (Gen 17 von 17)

and used for Transit routes. (Transitpost von S. 8. 1955)
and used for Transit routes. (Transitpost von S. 8. 1955)
and used for Transit routes. (Transitpost von S. 8. 1955)