

**Tower Crane / Grue à tour / Gru a torre
Grúa torre / Guindaste de torre**

Turmdrehkran 80 LC

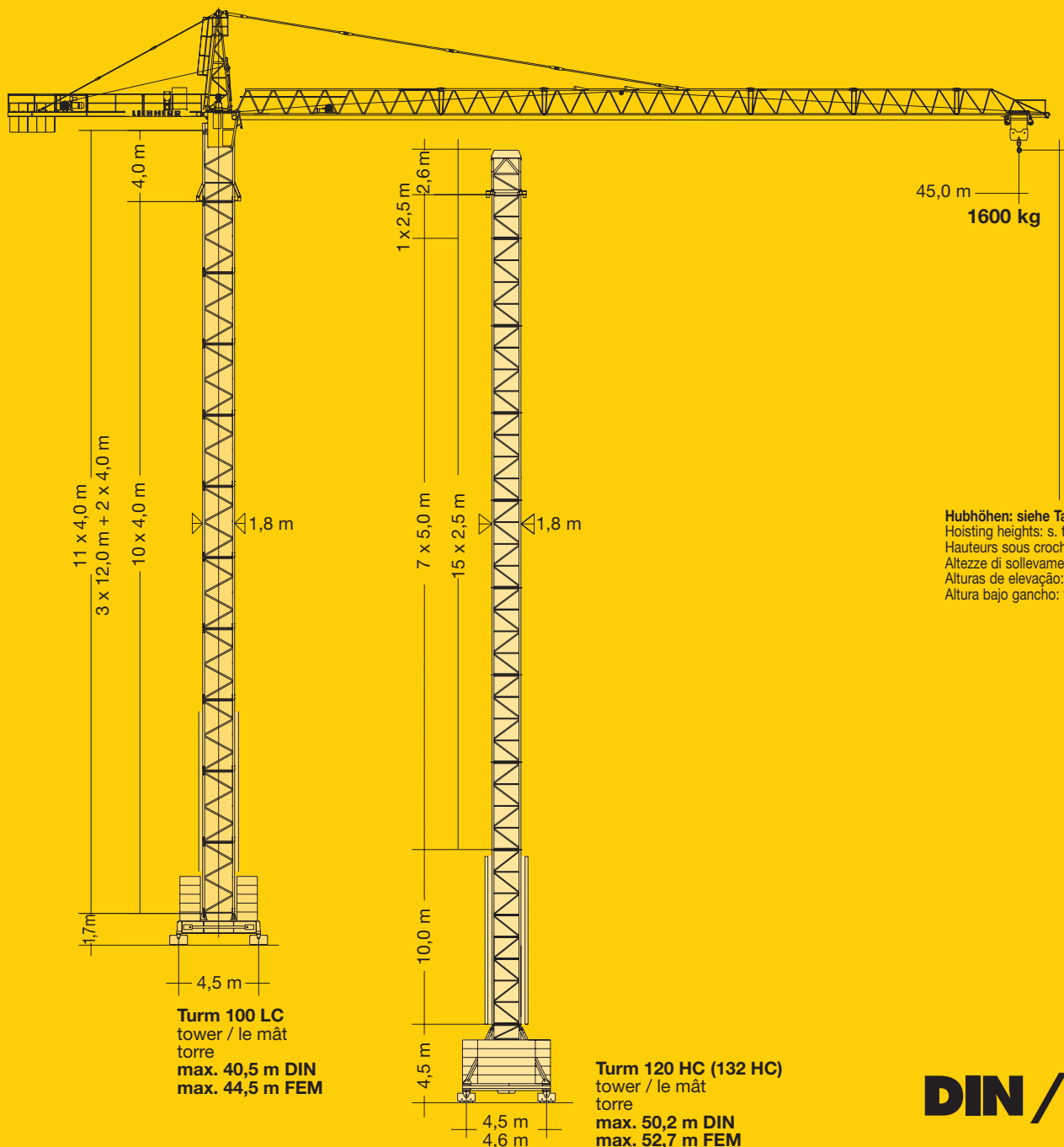

Hubhöhen: siehe Tabellen
 Hoisting heights: s. tables
 Hauteurs sous crochet: v. tableaux
 Alteze di sollevamento: vedi le tabelle
 Alturas de elevação: veja-se as tabelas
 Altura bajo gancho: ver tablas

DIN / FEM

1 : 350



LIEBHERR

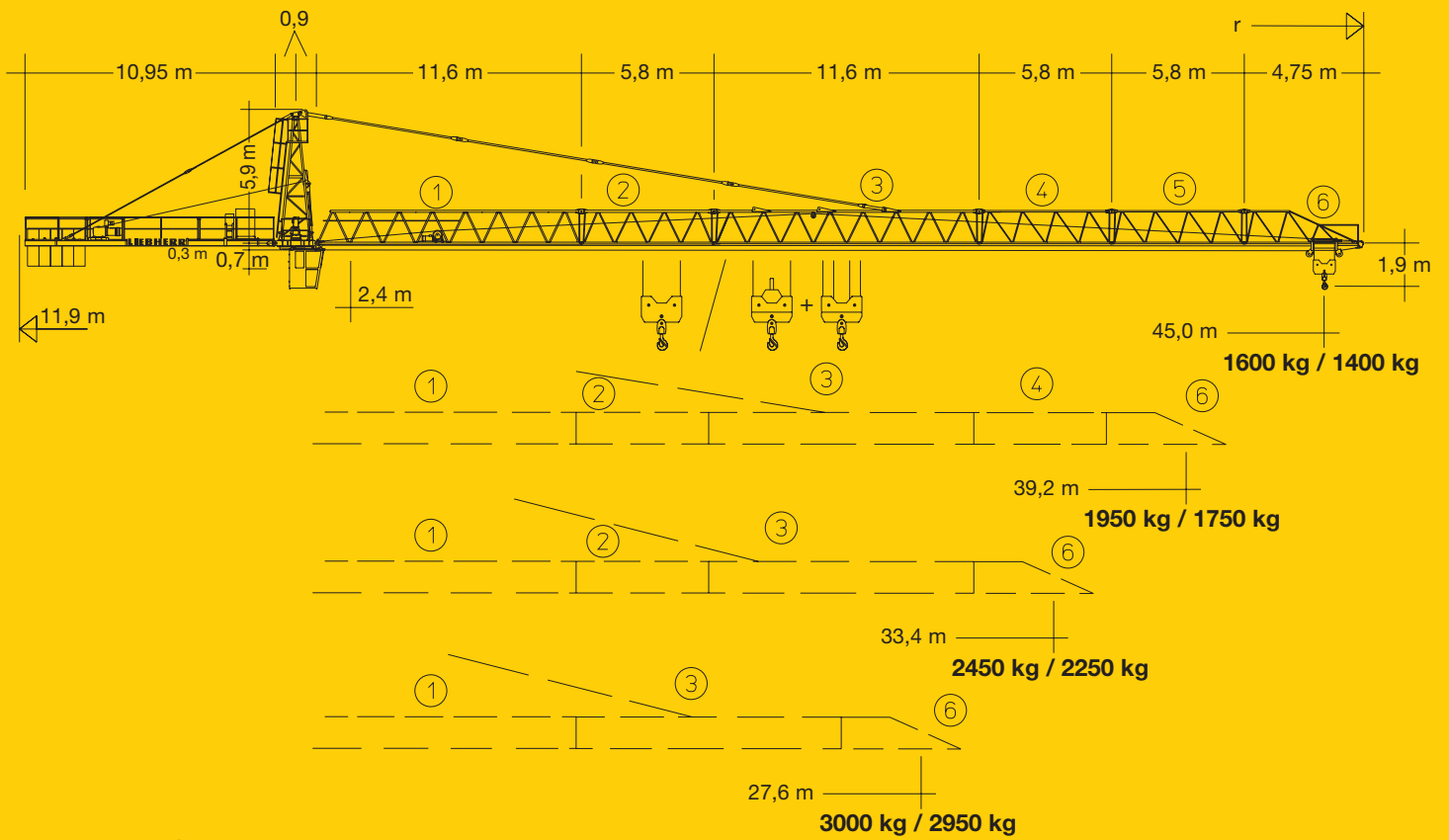

Gewicht

Weight / Poids / Peso / Peso / Pesos

Zentralballast / Central ballast Lest de base / Zavorra centrale Lastro central / Lastre central	75000 kg		(Ausl. 50 m)	9750 kg		35400 kg
--	----------	--	--------------	---------	--	----------

Hubhöhe

Hoisting height / Hauteur sous crochet / Altezza di sollevamento / Altura bajo gancho / Altura de montagem

		100 LC			
4 m FEM 11 DIN 10 9 8 7 6 5 4 3 2 1	12 m 3 2 1	44,5*	44,4*	44,1*	43,1*
		40,5*	40,4*	40,1*	39,1*
		36,5	36,4	36,1	35,1
		32,5	32,4	32,1	31,1
		28,5	28,4	28,1	27,1
		24,5	24,4	24,1	23,1
		20,5	20,4	20,1	19,1
		16,5	16,4	16,1	15,1
		12,5	12,4	12,1	11,1
		8,5	8,4	8,1	7,1
		4,5	4,4	4,1	3,1

* Weitere Hubhöhen auf Anfrage. / Further hoist heights on request. / Hauteurs sous crochet sur demande. / Altre altezze di sollevamento: su richiesta. / Outras alturas de elevação: conforme ao pedido. / Para alturas bajo gancho superiores, consultar.



80 LC

Ausladung und Tragfähigkeit

Radius and capacity / Portée et charge / Sbraccio e portata / Alcances y cargas / Alcance e capacidade de carga

m	r	m/kg	m/kg														
			15,0	17,0	19,0	21,0	23,0	25,0	27,6	31,0	33,4	37,0	39,2	41,0	43,0	45,0	
45,0	(r=46,4)	2,4-26,4 3000								2850	2490	2290	2020	1890	1790	1690	1600
39,2	(r=40,6)	2,4-27,1 3000								2940	2570	2350	2090	1950			
33,4	(r=34,8)	2,4-28,0 3000								3000	2670	2450					
27,6	(r=29,0)	2,4-27,6 3000								3000							

m	r	m/kg	m/kg		m/kg												
			2,4-24,9 3000	2,4-13,8 6000	15,0	17,0	19,0	21,0	23,0	25,0	27,6	31,0	33,4	37,0	39,2	41,0	43,0
45,0	(r=46,4)	2,4-24,9 3000	2,4-13,8 6000	5460	4720	4140	3680	3300	2980	2650	2280	2090	1820	1690	1590	1490	1400
39,2	(r=40,6)	2,4-25,5 3000	2,4-14,2 6000	5630	4870	4270	3800	3410	3080	2730	2370	2150	1890	1750			
33,4	(r=34,8)	2,4-26,4 3000	2,4-14,6 6000	5850	5060	4450	3950	3550	3210	2850	2470	2250					
27,6	(r=29,0)	2,4-27,2 3000	2,4-15,0 6000	6000	5230	4590	4090	3670	3320	2950							

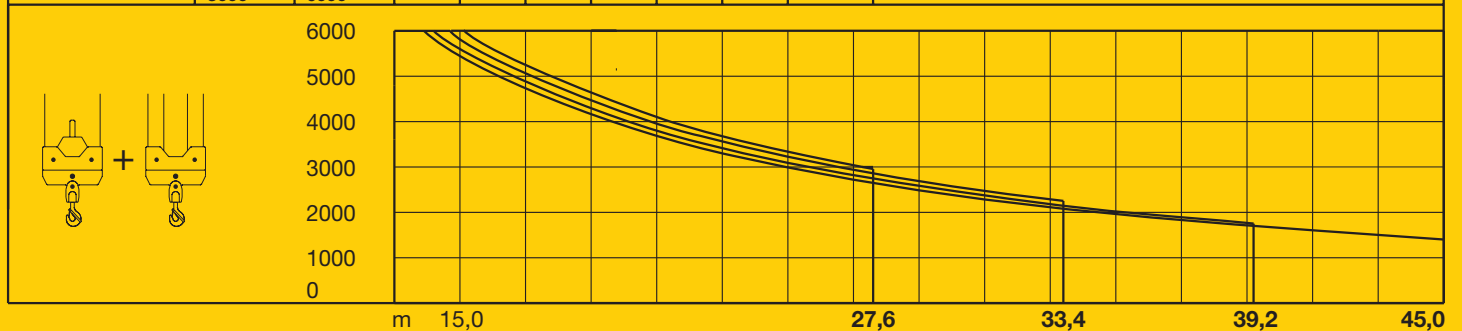







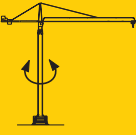
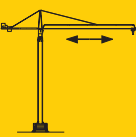

		120 HC (132 HC)				
FEM	15	52,7*	52,2*	48,4*	49,9*	49,7*
DIN	14	50,2	49,7	45,9	47,4	47,2
	13	47,7	47,2	43,4	44,9	44,7
	12	45,2	44,7	40,9	42,4	42,2
	11	42,7	42,2	38,4	39,9	39,7
	10	40,2	39,7	35,9	37,4	37,2
	9	37,7	37,2	33,4	34,9	34,7
	8	35,2	34,7	30,9	32,4	32,2
	7	32,7	32,2	28,4	29,9	29,7
	6	30,2	29,7	25,9	27,4	27,2
	5	27,7	27,2	23,4	24,9	24,7
	4	25,2	24,7	20,9	22,4	22,2
	3	22,7	22,2	18,4	19,9	19,7
	2	20,2	19,7	15,9	17,4	17,2
	1	17,7	17,2	13,4	14,9	14,7
	0	15,2	14,7	10,9	12,4	12,2

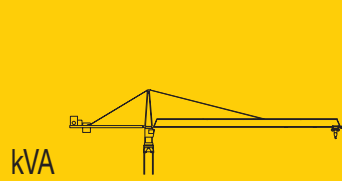
Unterwagen: ① fahrbar, ② stationär. ③ Fundamentanker. Fundamentkreuz: ④ fahrbar, ⑤ stationär. / Undercarriage: ① rail-going, ② stationary. ③ Foundation anchors. Cruciform base: ④ rail-going, ⑤ stationary. / Châssis: ① mobile, ② stationnaire. ③ Pieds de scellement. Châssis en croix: ④ mobile, ⑤ stationnaire. / Carro: ① traslante, ② stazionario. ③ Tirafondi. Crociera di fondazione: ④ traslante, ⑤ stazionario. / Carretón: ① móvil, ② estacionaria. ③ Pies de anclaje. Base cruciforme: ④ móvil, ⑤ estacionaria. / Chassis: ① Móvel, ② Estacionária. ③ Pés de ancoragem. Base cruciforme: ④ Móvel, ⑤ Estacionária.

Geschwindigkeiten

Speeds / Vitesse / Velocità / Velocidades / Velocidades

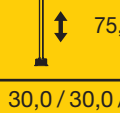















	0,8 min ⁻¹	5,0 kW
	9,0/30,0/60,0 m/min	0,65/2,0/3,0 kW
	18,0 m/min 25,0 m/min	2 x 2,6 kW (100 LC) 2 x 3,0 kW (120 HC)
		18,5 kW 30,0 kW
kVA		33,0 40,0

	Stufe / Step Cran / Marcia Marcha / Marcha	kg	m/min
 2 Lagen Layers Couches strati camadas capas 61,0 m	1	3000	6,5
	2	3000	32,0
	3	1400	64,0
 7 Lagen Layers Couches strati camadas capas 149,0 m  75,0 m	1	3000	5,3
	2	3000	27,0
	3	1300	53,0
	1	6000	2,6
	2	6000	13,0
	3	2800	27,0
 7 Lagen Layers Couches strati camadas capas 257,0 m  128,0 m		3000	8,4
		3000	44,0
		1350	90,0
		6000	4,2
		6000	22,0
		2850	45,0

Kolli-Liste

Packing List / Liste de colisage / Lista dei colli
Lista de embalagem / Lista de dimensiones y pesos

Montagegewichte: siehe Betriebsanweisung.
Erection weights: see instruction manual.
Poids de montage: voir manuel de service.
Pesi di montaggio: vedasi le istruzioni sull'uso.
Pesos de montaje: vejam-se as instruções p. uso.
Peso para el montaje: según manual.

Kranoberteil		Upper part of crane / Partie supérieure de gru Parte superiore della gru / Parte superior grúa Parte superior do guindaste	L (m)	B (m)	H (m)	kg
Pos. Item Rep. Voce Ref. Pos.	Anz. Qty. Qte. Qta. Quant. Cant.	Kabine + Steuerstand / Cabin + Seat Cabine + fauteuil / Cabina + poltrona Cabine + cadeira / Cabina + butaca				
1	1		1,87	1,12	2,18	440
2	1	Turmspitze / Tower head section Porte-flèche / Testa porta-braccio Cabeça de apoio de lança / Cabeza de torre				
			5,62	1,16	1,57	740
3	1	Gegenausleger / Counter-jib Contre-flèche / Contrabaccio Contra-lança / Contrapluma				
			11,03	1,67	0,45	1480
4	1	Ausleger-Anlenkstück / Jib heel section Pied de flèche / Settore articolato di braccio Base articulada de lança / Pluma tramo primero				
			11,79	1,17	1,59	① 1370
5	1	Ausleger-Zwischenstück / Intermediate jib section Elément interm. de flèche / Spezzone di braccio Peça suplementar da lança / Tramo intermedio pluma				
			6,03 11,83 6,02 6,00	1,17 1,17 1,17 1,17	1,54 1,63 1,53 1,51	② 483 ③ 877 ④ 323 ⑤ 267
6	1	Ausleger-Kopfstück / Jib head Pointe de flèche / Punta freccia Cabeça de lança / Tramo punta de pluma				
			4,96	1,17	1,72	⑥ 245
7	1	Podeste / Platforms Plates-formes / Plattaforma Plataforma / Plataforma				
			1,68	0,33	1,82	166
8	1	Laufkatze / Trolley Chariot / Carrello Carrinho / Carrito				
			1,57	1,34	0,77	170

CD-

Technische Daten

Technical data - Caractéristiques techniques

Caratteristiche tecniche - Características técnicas - Datos técnicos

Pos. Anz.
Item Qty.
Rep Qté.
Voce Qta.
Ref Quant.
Pos. Cant.

L (m) B (m) H (m) kg

Einzelgewichte / Single weights / Pesi individuali.
Pesi di componenti.
Pesos de peças componentes.
Pesos unitarios.

9	1	Drehbühne mit Kud-Auflage / Slewing platform with slewing ring support / Ensembles mât cabine avec pivot cage / Piattaforma girevole con supporto della ralla di rotazione / Plataforma giratória con suporte de corôa dentada / Asiento pista con plataforma giratoria		1,60	2,01	1,93	2590
10	1	Hubwerk / Winch Treuil / Verricello / Mecanismo elevatorio / Mecanismo elevación carga		1,50	1,36	0,71	655

Turnm Tower / Mât / Torre Torre / Torre

11	1	Turmstück / Tower section Element de mât / Elemento di torre Torre / Torre		12 m 4 m	12,27 4,27	1,80 1,80	1,80 1,90	2870 1105
----	---	---	--	-------------	---------------	--------------	--------------	--------------

Klettereinrichtung Climbing equipment / Equipement de télescopage / Attrezzatura per allungamento della gru Acessórios p. subida no edificio / Equipo de trepado

12	1	Führungsstück kpl. / Guide section cpl. Cage télescopique cpl. / Gabbia di sopraelevazione compl. Peça de guia compl. / Torre de montaje completa		8,92	2,25	2,35	2180
13	1	KUD-Auflagenverlängerung / Slewing ring support extension Rehausse de pivot d'orientation / Prolunga supporto ralla Peça de guia / Prolongación asiento de pista		4,27	2,26	2,26	1370
14	1	Hydraulikanlage, Stütz- und Klettertraverse / Hydraulic unit, supporting and climbing cross members Système hydraulique avec traverses d'appui et de télescopage / Sistema idraulico, traversa di appoggio e allungamento gru Instalação hidráulica, travessa de apoio e subida / Sistema hidráulico con traviesa de apoyo y trepado					

Fundamentkreuz Cruciform base / Châssis en croix / Carro della gru Carro de guindaste / Base cruciforme

15	1	Tragholm I / Arm I Longeron I / Longherone I Travessa I / Brazo I		6,66	0,71	0,75	2110
16	2	Tragholm II / Arm II Longeron II / Longherone II Travessa II / Brazo II		6,66	0,78	0,75	2330
17	2	Fahrschemel mit Antrieb / Rail bogie with drive Bogie moteur / Telaio con gruppo propulsore Quadro sem grupo de propulsão / Caja rodillo motriz		1,07	0,52	0,65	460
18	2	Fahrschemel ohne Antrieb / Rail bogie without drive Bogie fou / Telaio senza gruppo propulsore Quadro com grupo de propulsão / Caja rodillo conducido		1,07	0,25	0,65	380
19	1	Seile und Kleinteile / Small parts and ropes Accessoire et câbles / Accessori cavi Accesorios e cabos / Accesorios y cables		-	-	-	4600

Klettern im Gebäude

Climbing in the building / Élevées et hissage dans le bâtiment

Pure varianti di gru allungabili / Subida no edificio / Trepado dentro del edificio

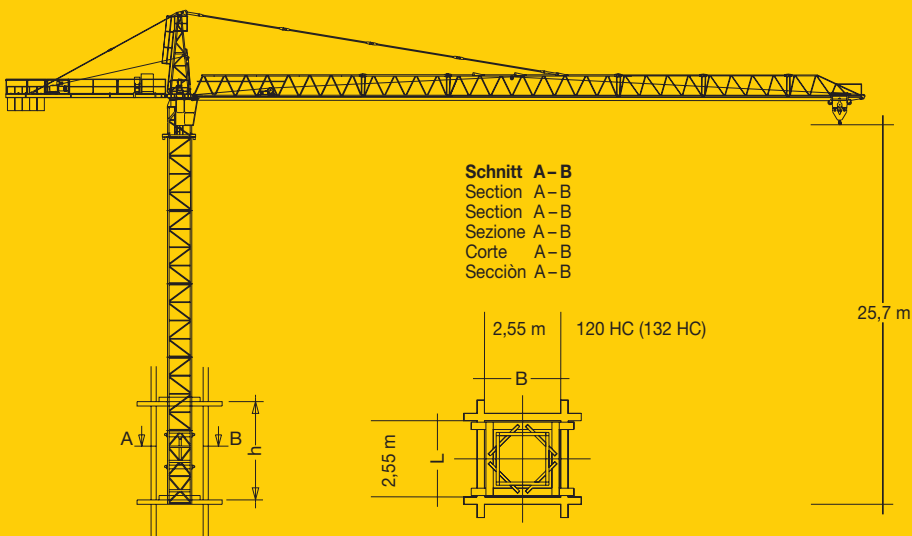

121 P – 3318 H1 B3 DIN 15018 • BGL 2112-0080 / FEM (Section 1) Krangruppe A3 • 09.00 / 6

Konstruktionsänderungen vorbehalten! / Subject to alterations!
Sous réserves de modifications! / Si fa riserva di modifiche!
Salvo modificação da construção! / ¡Sujeto a modificaciones!

Printed in Germany.



LIEBHERR-WERK BIBERACH GMBH, Postfach 1663, D-88396 Biberach an der Riß
☎ (0 73 51) 41-0, Fax (0 73 51) 41 22 25, www.lbc.liebherr.de, E-Mail: info@lbc.liebherr.com