

Turmdrehkran

Tower Crane / Grue à tour / Gru a torre / Grúa torre
Guindaste de torre / Башенный поворотный кран

285 EC-B 12 Litronic®

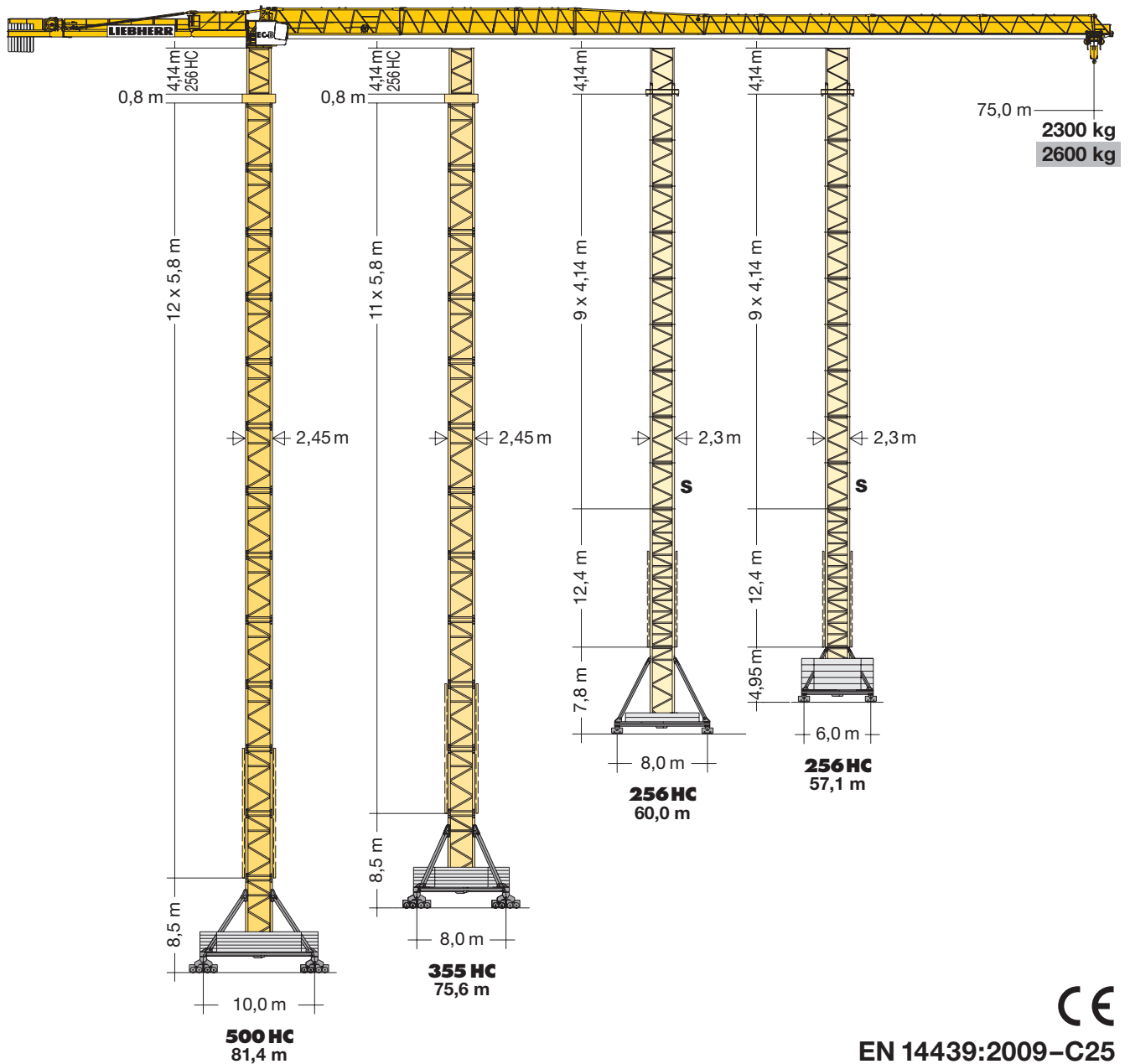

EN 14439:2009-C25

LIEBHERR

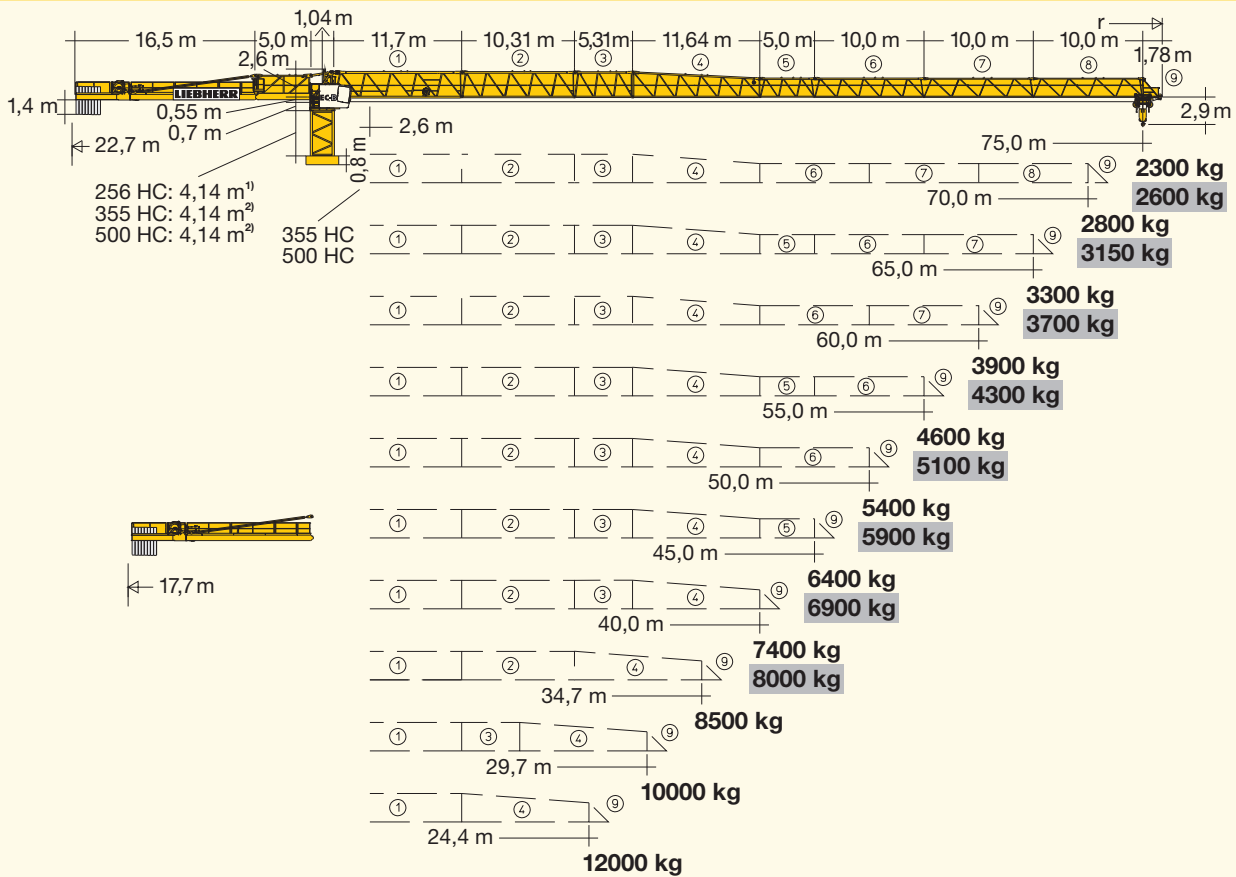

¹⁾ **Turmstück oder Kletterturmstück.** / Tower section or climbing tower section. / Élément de mât ou élément de mât télescopable. / Elemento torre oppure elemento torre telescopabile. / Tramo torre o tramo torre trepable. / Segmento de torre ou segmento de torre para ascensão. Башенная секция или секция наращивания.

²⁾ **Turmstück 256 HC.** / Tower section 256 HC. / Élément de mât 256 HC. / Elemento di torre 256 HC. / Tramo torre 256 HC. Segmento de torre 256 HC. / Башенная секция 256 HC.

Hubhöhe

Hoisting height / Hauteur sous crochet / Altezza di sollevamento
 Altura bajo gancho / Altura de montagem / Высота подъема

		256 HC			
C 25	13	-	-	-	-
	12	-	-	-	-
	11	-	-	-	-
	10	56,6*	-	-	-
	9	52,4*	64,9*	57,1*	60,0*
	8	48,3	60,7*	53,0*	55,9*
	7	44,1	56,6	48,8	51,7
	6	40,0	52,4	44,7	47,6
	5	35,8	48,3	40,5	43,4
	4	31,7	44,2	36,4	39,3
	3	27,6	40,0	32,3	35,2
2	23,4 S	35,9 S	28,1	31,0	
1	19,3 S	31,7 S	24,0 S	26,9 S	
0	15,1	27,6	19,8	22,7	
m					

* **Weitere Hubhöhen, Auslegerlängen sowie Klettern im Gebäude auf Anfrage.** / Further hoist heights and jib lengths as well as climbing inside the building on request. / Autres hauteurs sous crochet et longueurs de flèche ainsi que hissage dans le bâtiment sur demande. / Ulteriori altezze gancho, lunghezze braccio così come telescopaggio all'interno dell'edificio: su richiesta. / Para alturas bajo gancho superiores, otros alcances y trepado en el interior del edificio, consultar. / Outras alturas de elevação, comprimentos de lança e subida no edifício: sob consulta. / Другие высоты подъема, длины стрелы и самоподъем в здании – по запросу. **S** = verstärkt / reinforced / renforcé / rinforzato / reforzado / reforçado / усиленный

Ausladung und Tragfähigkeit

Radius and capacity / Portée et charge / Sbraccio e portata
Alcances y cargas / Alcance e capacidade de carga / Вылет и грузоподъемность

m	r	m/kg	285 EC-B 12										
			24,4	29,7	34,7	40,0	45,0	50,0	55,0	60,0	65,0	70,0	75,0
75,0	(r = 76,6)	2,6-20,0 12000	9590	7630	6350	5340	4610	4030	3560	3160	2830	2550	2300
70,0	(r = 71,6)	2,6-21,4 12000	10330	8240	6860	5790	5010	4390	3880	3460	3100	2800	
65,0	(r = 66,6)	2,6-22,3 12000	10860	8670	7230	6110	5290	4640	4110	3670	3300		
60,0	(r = 61,6)	2,6-23,4 12000	11430	9140	7630	6450	5600	4920	4360	3900			
55,0	(r = 56,6)	2,6-24,4 12000	11980	9580	8010	6780	5890	5180	4600				
50,0	(r = 51,6)	2,6-25,2 12000	12000	9960	8330	7060	6140	5400					
45,0	(r = 46,6)	2,6-26,1 12000	12000	10360	8670	7360	6400						
40,0	(r = 41,6)	2,6-26,2 12000	12000	10420	8730	7400							
34,7	(r = 36,6)	2,6-25,6 12000	12000	10160	8500								
29,7	(r = 31,3)	2,6-25,3 12000	12000	10000									
24,4	(r = 26,0)	2,6-24,4 12000	12000										

LM 1

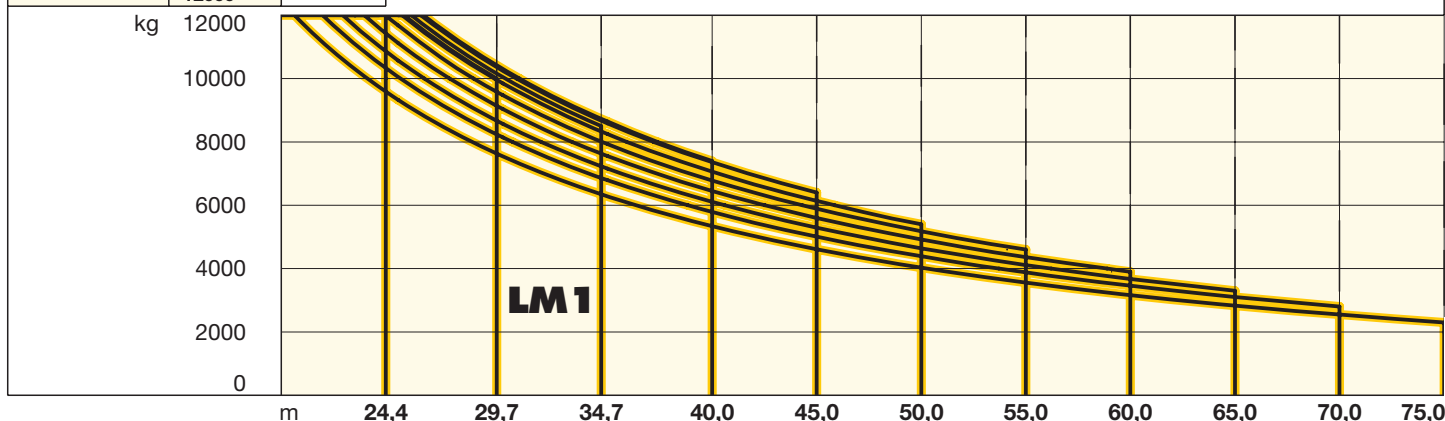

Hubhöhe

Hoisting height / Hauteur sous crochet / Altezza di sollevamento
Altura bajo gancho / Altura de montagem / Высота подъема

C 25	355 HC			500 HC		
	m	m	m	m	m	m
13	-	-	-	79,1*	-	-
12	-	-	-	73,3	85,5*	81,4*
11	67,5*	-	75,6*	67,5	79,7	75,6
10	61,7	73,3*	69,8*	61,7	73,9	69,8
9	55,9	67,5	64,0	55,9	68,1	64,0
8	50,1	61,7	58,2	50,1	62,3	58,2
7	44,3	55,9	52,4	44,3	56,5	52,4
6	38,5	50,1	46,6	38,5	50,7	46,6
5	32,7	44,3	40,8	32,7	44,9	40,8
4	26,9	38,5	35,0	26,9	39,1	35,0
3	21,1	32,7	29,2	21,1	33,3	29,2
2	15,3	26,9	23,4	15,3	27,5	23,4
1	9,5	21,1	17,6	9,5	21,7	17,6
0	3,7	15,2	11,8	3,7	15,9	11,8

Ausladung und Tragfähigkeit

Radius and capacity / Portée et charge / Sbraccio e portata
Alcances y cargas / Alcance e capacidade de carga / Вылет и грузоподъемность

m	r	m/kg	285 EC-B 12 Litronic®										
			25,0	30,0	35,0	40,0	45,0	50,0	55,0	60,0	65,0	70,0	75,0
75,0	(r = 76,6)	2,6–21,7 12000	10240	8300	6930	5910	5120	4480	3970	3540	3180	2870	2600
70,0	(r = 71,6)	2,6–23,2 12000	11040	8970	7500	6400	5560	4880	4330	3870	3480	3150	
65,0	(r = 66,6)	2,6–24,3 12000	11620	9450	7910	6760	5870	5160	4590	4110	3700		
60,0	(r = 61,6)	2,6–25,2 12000	12000	9840	8250	7050	6130	5400	4800	4300			
55,0	(r = 56,6)	2,6–26,4 12000	12000	10400	8720	7470	6500	5730	5100				
50,0	(r = 51,6)	2,6–27,1 12000	12000	10690	8970	7680	6690	5900					
45,0	(r = 46,6)	2,6–27,8 12000	12000	11000	9230	7920	6900						
40,0	(r = 41,6)	2,6–28,0 12000	12000	11110	9330	8000							

LM1 + LM2

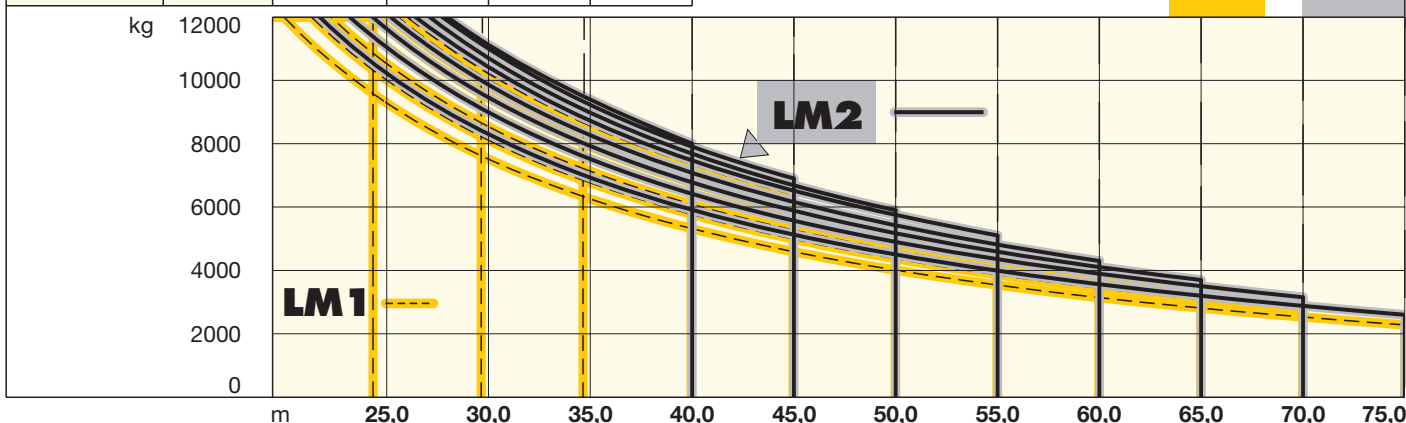

Antriebe Litronic®

Driving units / Mécanismes d entraînement / Meccanismi / Mecanismos / Mecanismos / Приводы

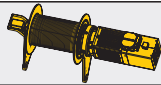

45 kW FU
WIW 260 MZ 405 5 **Lagen**
Layers
Couches
Avvolgimenti
Camadas
Capas
Слоёв

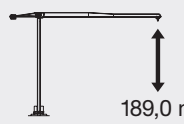

189,0 m

max. 325,0 m**

↔ **stufenlos** / stepless / régl. continu
régl. progressive / sin escalones / sem degraus
бесступенчатый kg m/min

1	12000	0 ↔ 19
	1150	0 ↔ 90

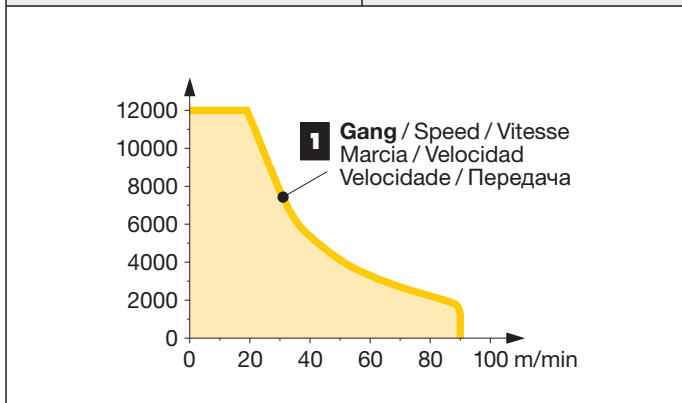

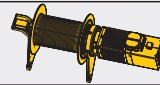

65 kW FU
WIW 280 MZ 402 7 **Lagen**
Layers
Couches
Avvolgimenti
Camadas
Capas
Слоёв

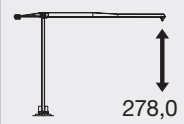

278,0 m

max. 325,0 m**

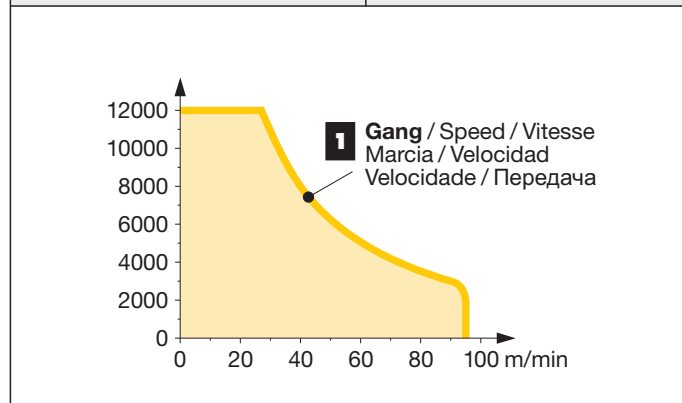

↔ **stufenlos** / stepless / régl. continu
régl. progressive / sin escalones / sem degraus
бесступенчатый kg m/min

1	12000	0 ↔ 27
	2300	0 ↔ 95

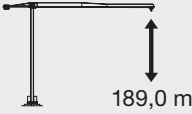
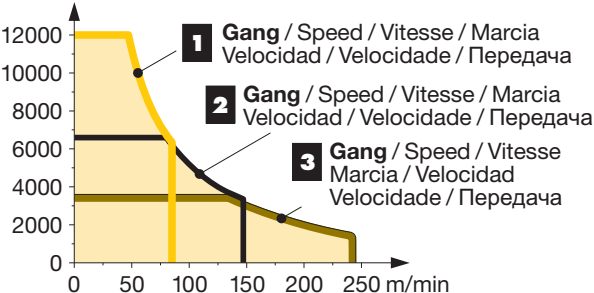

** Weitere Hublastdaten: siehe Betriebsanleitung. / Further hoist load data: see instruction manual. / Autres données de la charge de levage: voir manuel d'instruction. / Altri dati sui carichi sollevati: consultare il manuale d'istruzione. / Alturas bajo grancho superiores según manual. / Outras tabelas de carga: consultar manual de instruções. / Другие данные по весу поднимаемых грузов: см. инструкцию по эксплуатации

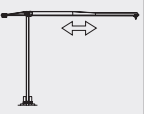
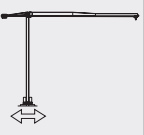
	↔ stufenlos / stepless / régl. continu regl. progressiva / sin escalones / sem degraus бесступенчатый kg m/min												
110 kW FU WIW 300 VZ 409 5 Lagen Layers Couches Avvolgimenti Camadas Capas Слоёв  189,0 m max. 325,0 m**	<table border="1"> <tr> <td>1</td> <td>12000 0 ↔ 47</td> </tr> <tr> <td></td> <td>5600 0 ↔ 85</td> </tr> <tr> <td>2</td> <td>6600 0 ↔ 80</td> </tr> <tr> <td></td> <td>2900 0 ↔ 147</td> </tr> <tr> <td>3</td> <td>3600 0 ↔ 134</td> </tr> <tr> <td></td> <td>1300 0 ↔ 245</td> </tr> </table>	1	12000 0 ↔ 47		5600 0 ↔ 85	2	6600 0 ↔ 80		2900 0 ↔ 147	3	3600 0 ↔ 134		1300 0 ↔ 245
1	12000 0 ↔ 47												
	5600 0 ↔ 85												
2	6600 0 ↔ 80												
	2900 0 ↔ 147												
3	3600 0 ↔ 134												
	1300 0 ↔ 245												
													

	U/min 0 ↔ 0,7 sl./min tr./min	2 x 7,5 kW FU				
	0 ↔ 110,0 m/min	7,5 kW FU				
	25,0 m/min	4 x 7,5 kW (500 HC) 4 x 5,5 kW (355 HC) 2 x 7,5 kW (256 HC)				
	kVA	<table border="1"> <tr> <td>45 kW FU</td> <td>65 kW FU</td> </tr> <tr> <td>63,0</td> <td>86,0</td> </tr> </table>	45 kW FU	65 kW FU	63,0	86,0
45 kW FU	65 kW FU					
63,0	86,0					



















kVA reduzierbar bei zu geringer Netz-Anschlussleistung, siehe BAL. kVA can be reduced in case of too little power of the mains, see instruction manual. / kVA peut être réduit en cas de trop faible puissance du réseau, voir manuel d'instruction. / kVA riducibili in caso di potenza di rete ridotta (si veda manuale uso e manutenzione) / kVA variable para potencia de red demasiado pequeña, ver Manual de instrucciones. / kVA reduzível no caso de capacidade da rede elétrica muito baixa, ver manual de instruções. / количество kVA может быть сокращено до минимальной общей потребляемой мощности, см. инструкцию по эксплуатации.

LM 2 Abweichende Geschwindigkeiten und Betriebsbedingungen. / Variant speeds and service conditions. / Vitesses et conditions de fonctionnement différentes. / Differenti velocità e condizioni di funzionamento. / Otras velocidades y características de funcionamiento. / Outras velocidades e características de funcionamento. / Нестандартные скорости и условия эксплуатации.

Kolli-Liste

Packing List / Liste de colisage / Lista dei colli
Lista de contenido / Lista de embalagem / Упаковочный лист

Montagegewichte: siehe Betriebsanleitung. / Erection weights: see instruction manual. / Poids de montage: voir manuel de service. / Pesi di montaggio: vedere manuale d'uso. / Peso para el montaje: según manual. / Pesos de montagem: veja-se as instruções p. uso. / Масса монтируемых частей: см. инструкцию по эксплуатации.

Kranoberteil		Upper part of crane / Partie supérieure de grue / Parte superiore della gru Parte superior grúa / Parte superior do guindaste / Верхняя часть крана	L (m)	B (m)	H (m)	kg*		
Pos. Item	Anz. Qty.	Drehbühne kpl. / Slewing platform cpl. Ensemble mât cabine cpl. / Piattaforma girevole compl. / Conjunto plataforma de giro / Plataforma giratória compl. Поворотная платформа в сборе			5,62	2,30	2,54	10800
1	1							
2	1	Gegenausleger / Counter-jib / Contre-flèche Controffaccia / Contrapluma / Contra-lança Консоль противовеса			11,80	2,45	2,54	10300
3		Gegenausleger-Anlenkstück / Counter-jib heel section Pied de contre-flèche / Settore articolato di controbraccio Tramo primero-contrapluma Base articulada da contra-lança / Корневая секция консоли противовеса			5,41	2,14	2,40	2600
4	1	Ausleger-Anlenkstück / Jib heel section Pied de flèche / Sezione articolata braccio Pluma tramo primero / Base articulada de lança Корневая секция стрелы			11,98	1,41	2,56	① 5300
5	1	Ausleger-Zwischenstück / Intermediate jib section Élément intermédiaire de flèche / Sezione intermedia braccio / Tramo intermedio pluma / Peça suplementar da lança / Промежуточная секция стрелы			10,60 5,60	1,35 1,35	2,49 2,49	② 2800 ③ 1340
6	1	Ausleger-Zwischenstück / Intermediate jib section Élément intermédiaire de flèche / Sezione intermedia braccio / Tramo intermedio pluma / Peça suplementar da lança / Промежуточная секция стрелы			11,90	1,35	2,43	④ 2250
7	1	Ausleger-Zwischenstück / Intermediate jib section Élément intermédiaire de flèche / Sezione intermedia braccio / Tramo intermedio pluma / Peça suplementar da lança / Промежуточная секция стрелы			5,24 10,24 10,24 10,24	1,35 1,35 1,35 1,35	1,84 1,86 1,86 1,86	⑤ 890 ⑥ 1380 ⑦ 1020 ⑧ 720
8	1	Ausleger-Kopfstück / Jib head section / Pointe de flèche / Punta braccio / Tramo punta de pluma Cabeça de lança / Концевая секция стрелы			1,90	1,54	2,05	⑨ 250
9	1	Laufkatze und Lasthaken / Trolley and hook Chariot de distribution et crochet / Carrello con gancio / Carrito y gancho / Carro de ponte e gancho / Грузовая тележка и грузовой крюк			1,87	1,84	1,66	910

Pos. Item Rep. Voce Pos. Ref. Поз.	Anz. Qty. Qte. Qta. Cant. Cant. Кол-во				L (m)	B (m)	H (m)	kg*	
Turm Tower / Mât / Torre Torre / Torre / Башня									
10	9	Turmstück / Tower section Elément de mât / Elemento di torre Tramo torre / Torre / Башенная секция			256 HC	4,14	2,30	2,30	2300
11	355 HC				6,28	2,45	2,45	5050	
13	500 HC				6,28	2,45	2,45	6480	
11	1	Turmstück lang / Long tower section Elément de mât long / Elemento di torre, lungo / Tramo de torre largo / Peça de torre, comprida / Башенная секция, длинная			256 HC	12,42	2,30	2,30	5770
12	1	Grundturmstück / Base tower section Mât de base / Elemento di torre base Tramo base / Peça de base de torre Секция основания			256 HC	8,85 (12,42)	2,30 (2,30)	2,30 (2,30)	4830 (7940)
13	1	Kletterturmstück / Climbing tower section Elément de hissage de mât / Elemento torre di telescopaggio / Tramo de trepado / Tramo de telescopagem / Секция самоподъема			256 HC	4,14	2,30	2,45	3300

Klettereinrichtung Climbing equipment / Equipement de télescage / Attrezzatura per allungamento della gru
Equipo de trepado / Acessórios p. subida no edifício / Обойма наращивания

14	1	Führungsstück kpl., geteilt / Guide section cpl., split / Cage télescopique cpl., devisée / Gabbia de sopraelevazione compl., suddivisa / Torre de montaje completa, dividida / Peça de guia compl., subdividida / Направляющая секция в сб., разъемная			256 HC	8,39	2,68	2,58 (3,04)	5100
	355 HC				12,39	2,75	1,58	8300	
	500 HC				12,39	2,75	1,58	8300	
15	1	Hydraulikanlage, Stütz- und Klettertraverse / Hydraulic unit, supporting and climbing cross members / Système hydraul. avec traverses d'appui et de télescop. Sist. idraul., traversa di appoggio e allugam. gru / Sistema hidráulico con traviesa de apoyo y trepado / Instalação hidráulica, travessa de apoio e subida / Гидроагрегат, стойка-упор и траверса обоймы наращивания			256 HC	2,10	1,25	1,00	1150
	355 HC				2,10	1,10	1,00	1810	
	500 HC				2,10	1,10	1,00	1810	

Unterwagen Undercarriage / Châssis / Carro
Carro con mástil / Carro de guindaste / Опорная рама

16	4	Ausgleichsschwinge mit Schwingenlager Pivot for wheel box / Chape pour bogie Bilanciere di equilibratura con cuscinetto bilanciere / Balancin / Balancim com suporte Балансир с шарнирной опорой			355 HC				
					500 HC	1,60	0,72	1,48	1390
17	2 4 4	Fahrschemel mit Antrieb / Rail bogie with drive Bogie moteur / Telajo con grappa propulsore Caja rodillo motriz / Quadra sem grupa de propulsão / Подрамник с приводом			256 HC	1,63 (1,46)	0,92 (0,84)	0,95 (0,87)	1690 (920)
	355 HC				1,40	0,75	0,65	920	
	500 HC				1,45	0,82	0,72	1690	
18	2 4 4	Fahrschemel ohne Antrieb / Rail bogie without drive / Bogie fou / Telajo senza grappa propulsore Caja rodillo conducido / Quadra com grupa de propulsão / Подрамник без привода			256 HC	1,37 (1,15)	0,62 (0,60)	0,95 (0,87)	1340 (880)
	355 HC				1,10	0,60	0,65	880	
	500 HC				1,30	0,40	0,72	1340	
19	1 2 2	Tragholm lang / Long support arm / Longeron long / Longherone lungo / Brazo soporte largo Travessa comprida / Несущая балка, длинная			256 HC	9,10 (11,85)	0,80 (0,82)	0,80 (0,80)	1650 (2200)
	355 HC				11,82	0,92	0,93	3515	
	500 HC				7,32	0,92	0,93	2330	
20	2	Tragholm kurz / Short support arm / Longeron court / Longherone corto / Brazo soporte corto Travessa curta / Несущая балка, короткая			256 HC	4,45 (5,58)	0,77 (0,65)	0,77 (0,77)	800 (1035)
	355 HC				5,74	0,80	0,90	1600	
	500 HC				7,14	0,80	0,90	2135	
21	2 + 2	Randträger / Border support / Traverse Supporti base Traviesa / Apoio de bordo / Стяжная балка			256 HC	5,46 - 5,40 (7,52 - 7,46)	0,11 - 0,18 (0,10 - 0,17)	0,16 - 0,38 (0,10 - 0,38)	175 - 525 (366 - 912)
	355 HC				7,30	0,14	0,14	340	
	500 HC				9,30	0,14	0,14	510	
22	4	Stützholm / Support strut / Hauban de châssis Correnti di appoggio / Tirante vertical Travessa de apoio / Опорный подкос			256 HC	4,14 (6,55)	0,18 (0,22)	0,25 (0,25)	320 (600)
	355 HC				6,06	0,26	0,34	862	
	500 HC				6,98	0,26	0,34	1140	
23	1	Unterwagen-Turmstück / Undercarriage tower section / Mât de châssis / Elemento di torre del carro / Tramo de carro / Peça de torre do chassis Опорная башенная секция			256 HC	3,73 (6,70)	2,62 (2,53)	2,62 (2,53)	2550 (3800)
	355 HC				6,61	2,44	2,44	7475	
	500 HC				6,61	2,44	2,44	7930	
24		Kleinteile, Seile und Abspannungen / Small parts, ropes and holding bars Accessoires, câbles et tirants / Accessori, funi e attrezzi di ancoraggio Despieces, cables y tirantes / Acessórios, cabos e peças de ancoragem Мелкие детали, Канаты и Пристезжи			256 HC				
	355 HC				9,00	1,60	1,00	4000	
	500 HC								

() **Angaben in Klammern gelten für 8 m-Unterwagen.** / The data in brackets are valid for an undercarriage of 8 m. / Les données techniques indiquées entre parenthèses sont valables pour un châssis de 8 m. / Caratteristiche in (...) valgono per carro di 8 m. / Los datos entre paréntesis son válidos para carro de 8 m. Características em (...) válidas pelo chassis de 8 m. / Данные в скобках относятся к 8-метровой опорной раме.

* **Einzelgewichte.** / Single weights. / Poids individuels. / Singoli pesi. / Pesos unitarios. / Pesos de peças componentes. / Индивидуальный вес.

Konstruktionsänderungen vorbehalten! / Subject to alterations! / Sous réserves de modifications! / Reservato il diritto di modifiche strutturali!
¡Sujeto a modificaciones! / Salvo modificação da construçao! / Права на внесение конструкторских изменений сохраняются!

Sämtliche Angaben erfolgen ohne Gewähr. / This information is supplied without liability. / Ces renseignements sont sans garantie. / Tutte le indicazioni fornite senza garanzia. / Declinamos toda responsabilidad derivada de la información proporcionada. / Declinamos qualquer responsabilidade quanto à informação fornecida. / Все данные указаны без обязательств.

121 P - 5852 • EN 14439:2009 - EN 13001-HC1/S2 • BGL C.0.10.0280 • 04.10 / 7

Printed in Germany.