

CRANES
and
MIXERS

Euro Kran

OMV 340

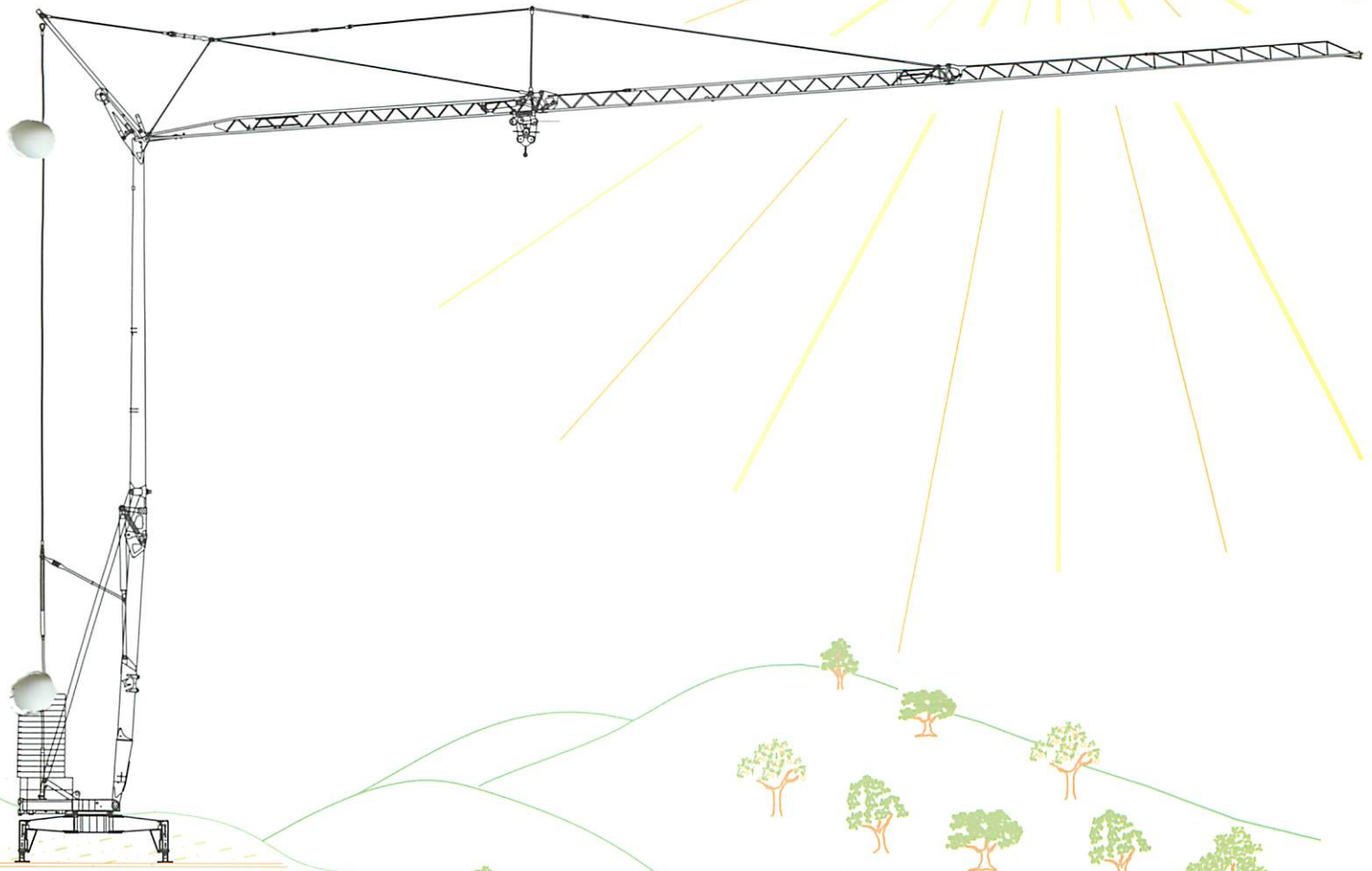

 **CE**

 **stiefel
service**

OMV 340

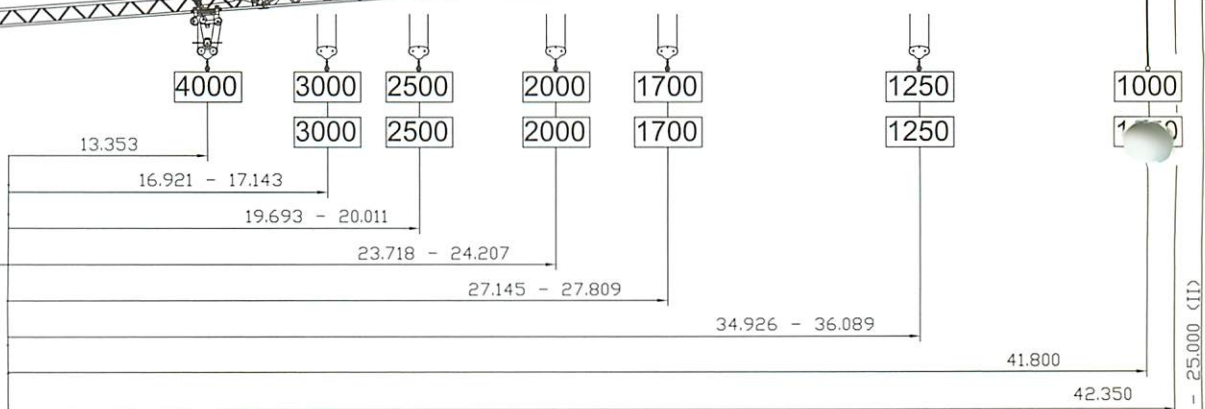
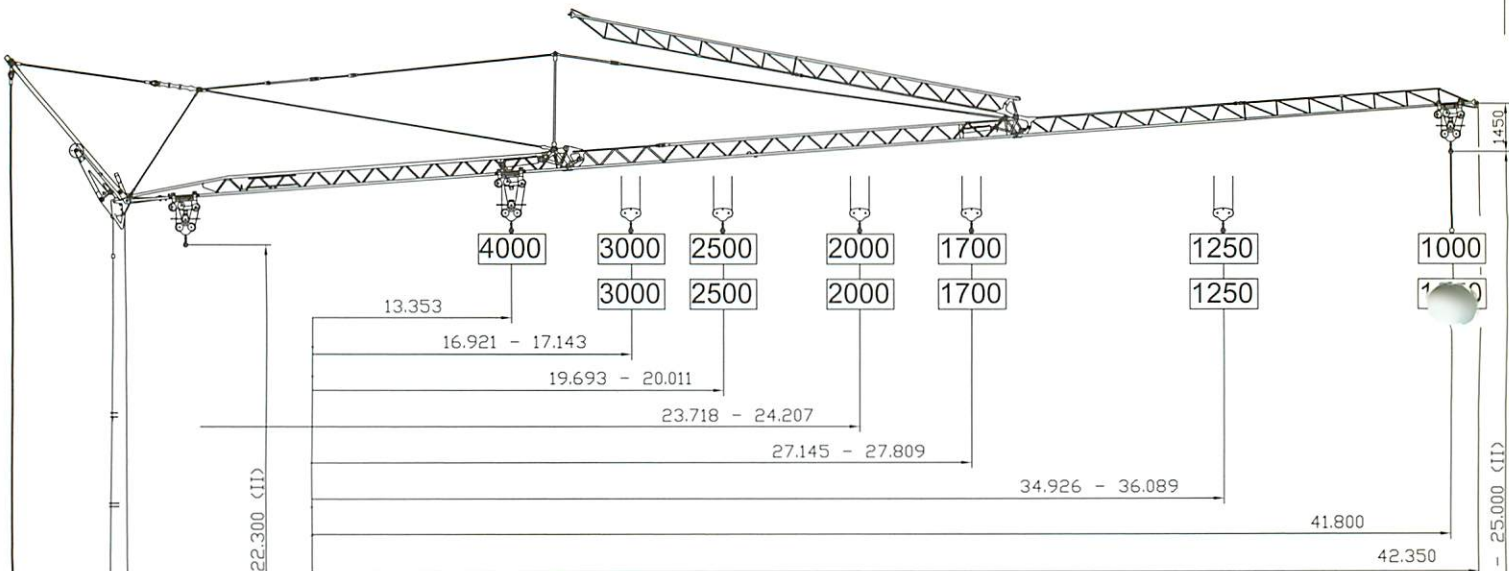
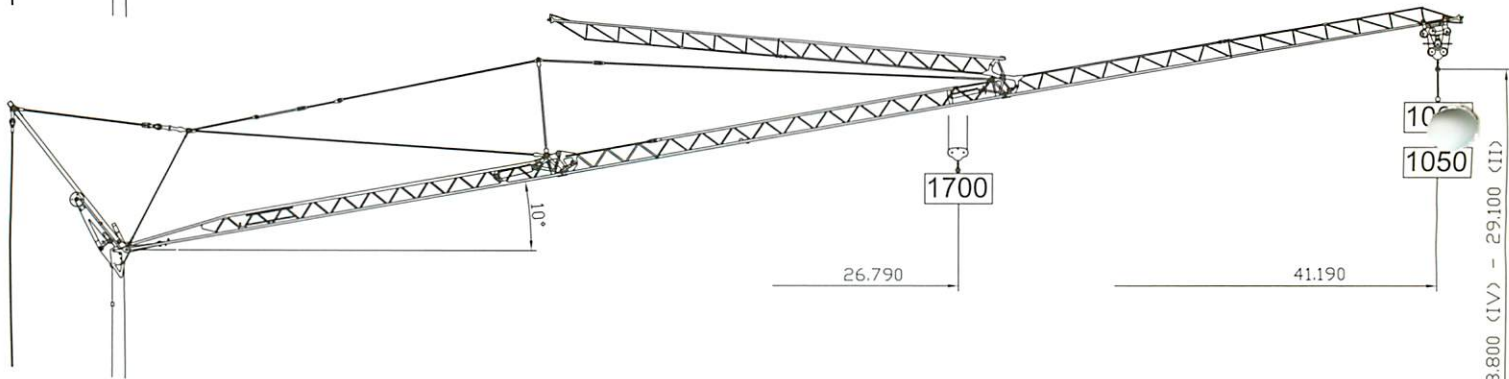
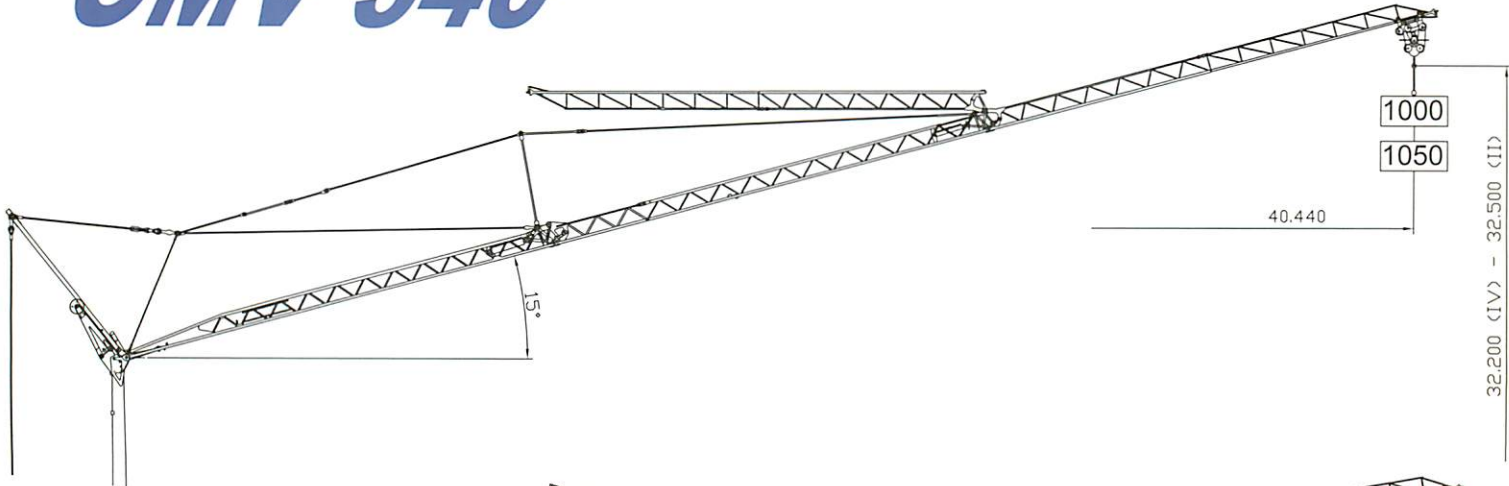

kg	3000	2831	2501	2236	2020	1839	1686	1555	1441	1341	1253	1175	1105	1050
m	17,1	18	20	22	24	26	28	30	32	34	36	38	40	41,8

kg	4000	3775	3209	2784	2454	2188	1971	1790	1637	1505	1391	1292	1204	1125	1055	1000
m	13,3	14	16	18	20	22	24	26	28	30	32	34	36	38	40	41,8



 DOTAZIONE DI SERIE

Sollevamento "overdrive" con inverter a 4 velocità, rotazione e carrello con inverter 3 velocità, zincatura della struttura e dei tiranti, contrappeso, braccio impennabile, carrello rampante con motore e finecorsa alla base della torre, funzionamento con braccio ripiegato, radiocomando integrato, pulsantiera di emergenza, carter di protezione per ralla e meccanismi, predisposizione per autozavorramento, armadio elettrico in acciaio inox, documentazione a norme CEE.

 STANDARD FEATURES

4-speed lifting, 3-speed rotation and trolley with inverter control, galvanised structure, counterweight, pull-up jib, translation trolley with motor and limit switch at base of gantry, operation with folden jib, remote radio control, emergency cable-operated control, guard for slewing ring and mechanisms, designed to allow installation of self-ballasting device, stainless steel electrical cabinet, documentation in accordance with EU standards.

 EQUIPEMENT DE SERIE

Levage a quatre vitesses, chariot et rotation à trois vitesses à contrôle électronique, galvanisation de la structure et des tirants, contrepoids, flèche relevable, moteur de chariot et fin de course à la base de la tour, fonctionnement bras replié, commande radio, commande d'urgence avec câble, carter de protection pour la couronne et les mécanismes, prédisposition pour auto lestage, armoire électrique en acier inox, documentation conforme aux normes CEE.

 SERIENAUSSTATTUNG

Heben mit vier Geschwindigkeiten, Laufkatzen- und Drehbewegung mit drei Geschwindigkeiten, Tragkonstruktion feuerverzinkt, Gegengewicht, hochklappbarer Ausleger, Laufkatzenbewegung in Schrägstellung des Auslegers, Laufkatzenmotor und Endscharter an der Basis des Turms, Betrieb mit eingeklapptem Ausleger, Steuerung mit Funk oder Druckknopftaste über Kabel, die mechanischen Teile sind alle durch eine Abdeckung geschützt, vorbereitet für Selbstballastierungseinrichtung, Schaltschrank aus rostfreiem Stahl, Dokumentation gemäß EC Vorschriften.

 DOTACION DE SERIE

Levantamiento a cuatro velocidades, carro y rotación a tres velocidades con control electrónico, galvanización de la estructura, contrapeso, brazo empuñable, carro rampante con motor y fin de carrera en la base de la torre, funcionamiento con brazo repliegado, radiocomando y pulsadores via cable por l'emergencia, cárter de protección para corona de giro y mecanismos, predisposición para autocontrapeso, armario eléctrico de acero inox, documentación según normas CEE.

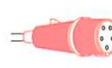
	400 V (+10% - 10%) 50 Hz	12 kVA
---	-----------------------------	--------

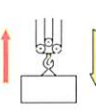

	m/l'	8	20	46	56
	kg	3000	3000	1200	800
	kW	11 (Inverter)			

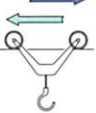
	m/l'	8-4	20-10	46-23	56-28
	kg	2000-4000	2000-4000	1200-2400	800-1600
	kW	11 (Inverter)			

	m/l'	17.3	28.6	53.5 (39.3)
	kW	3 (Inverter)		

	g/l'	0.27	0.54	0.75
	kW	3 (Inverter)		

	min	14
	kW	3

	18.500 Kg		8100 Kg + 19500 Kg
---	-----------	---	--------------------------

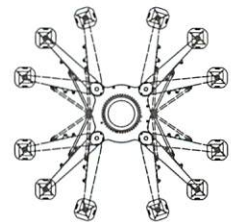
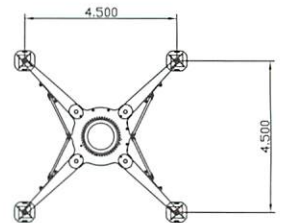
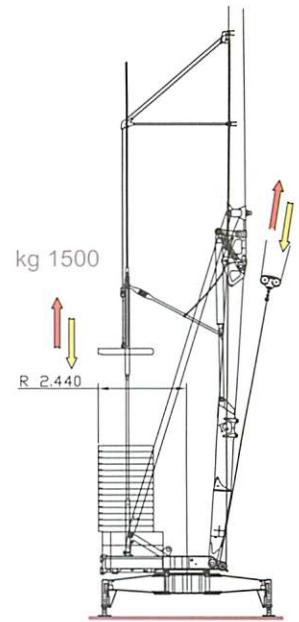

„Alle Euro Krane“ werden mit Hydraulikabstützung 600 mm Hub ausgeliefert. Jedes herkömmliche Kranfahrwerk und jeder geeignete Tieflader sind zum Straßentransport geeignet.

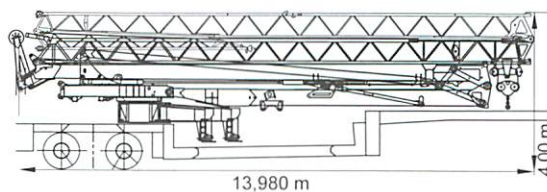

Unser Universalieflader, jede Achse gelenkt - Mittelbett - austauschbar für alle Modelle „ohne Ausnahmegenemigung zu fahren!“

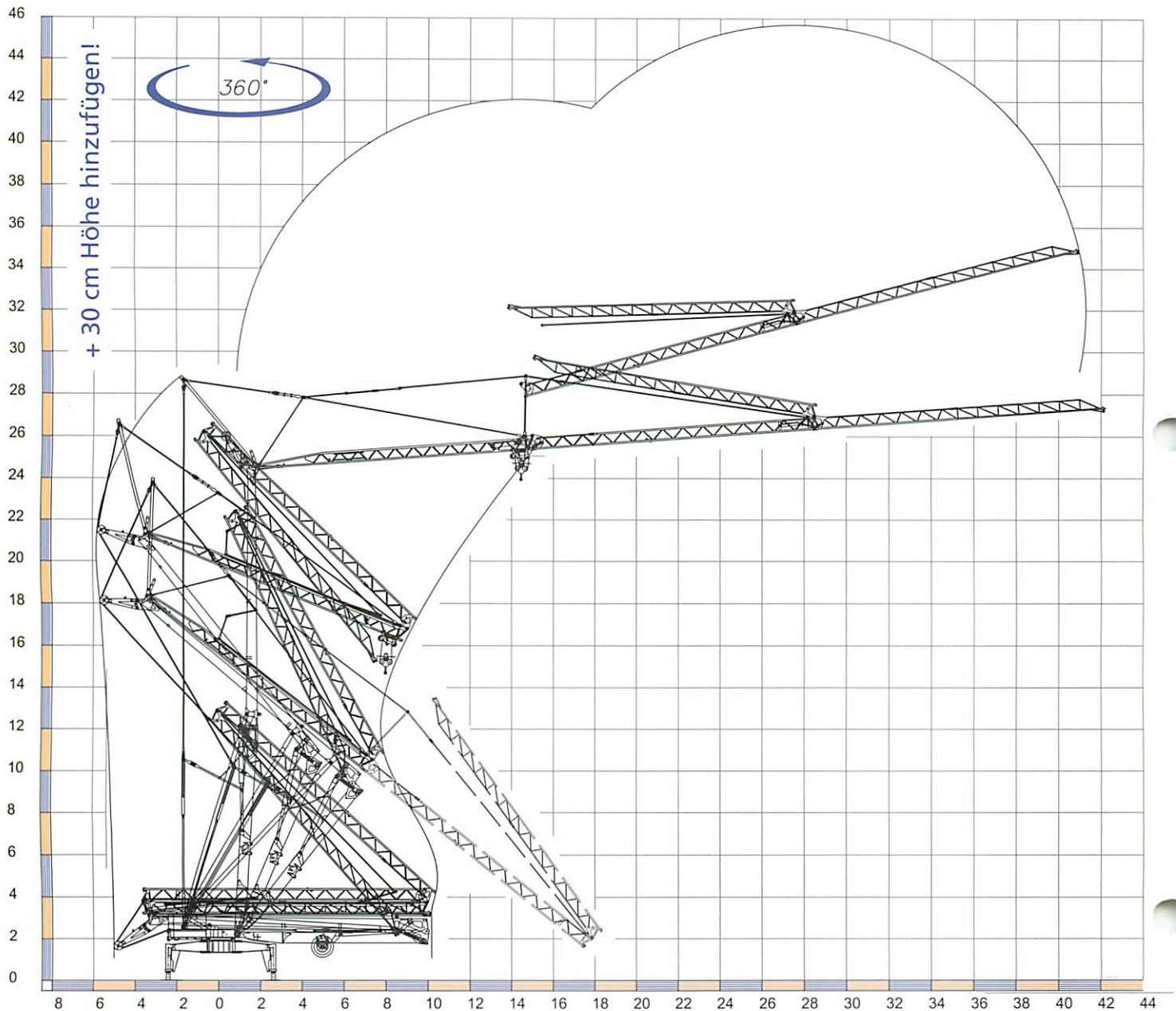

stiefel
service

Stiefel-Service
 Bau- und Industriemaschinen
 Hochholzstraße 40
 72336 Balingen-Zillhausen
 Tel.: 07435 650 oder 1650
 Fax: 07435 1598
 Mobil: 0171 6512876
 E-mail: baumaschinenstiefel@t-online.de
 Internet: www.baumaschinenstiefel.de